

UNIFIED DEVELOPMENT CODE



City of Cheyenne

Adopted January 23, 2012

Effective April 30, 2012

Last Amended March 20, 2025

PLAN CHEYENNE
IMPLEMENTATION

UNIFIED DEVELOPMENT CODE

Article 1 General Provisions

1.1	Overview	1-2
1.2	Review Authorities	1-4
1.3	Administration and Enforcement	1-7
1.4	Interpretation	1-12

Article 2 Applications, Procedures and Criteria

2.1	Divisions of Land	2-2
2.2	Zoning Applications	2-10
2.3	Appeals and Relief	2-23
2.4	Text Amendments and Annexations	2-27

Article 3 Impact Studies

3.1	Transportation Impact Studies	3-2
3.2	Drainage Impact Studies	3-11
3.3	[RESERVED]	3-22

Article 4 Subdivision Regulations

4.1	General Provisions	4-2
4.2	Community Facilities and Fees	4-3
4.3	Transportation Networks and Street Designs	4-8
4.4	Open Space Systems	4-37
4.5	Required Improvements and Engineering Specifications	4-42
4.6	Public Safety Fees	4-47

Article 5 Zoning Regulations

5.1	General Provisions	5-2
5.2	Rural and Agriculture Districts Standards	5-21
5.3	Residential Neighborhood Districts Standards	5-22
5.4	Commercial and Mixed-Use Districts Standards	5-26
5.5	Industrial Districts Standards	5-35
5.6	Special Purpose and Overlay Districts Standards	5-36
5.7	Specific Use Standards	5-49
5.8	Supplemental Provisions	5-54

Article 6 Design Regulations

6.1	General Provisions	6-2
6.2	Parking, Lot Access and Circulation	6-2
6.3	Landscape Standards	6-11
6.4	External Lighting	6-17
6.5	Signs	6-18
6.6	Residential Design Standards	6-28
6.7	Small-scale Commercial and Mixed-use Design Standards	6-38
6.8	Large-scale Commercial Design Standards	6-46
6.9	General Commercial Design Standards	6-49

Article 7 Form-Based Codes

7.1	General Provisions	7-2
7.2	Planning and Community Design Standards	7-5
7.3	Lot and Building Type Standards	7-6
7.4	Use Standards	7-13
7.5	Site and Building Standards	7-17

Appendices

A	Resources, Guides and Industry Standards	A-2
B	Design Guidelines	A-3
C	Transportation Worksheet	A-4
D	[Reserved]	A-8
E	Pedestrian and Bicycle Guidelines	A-9
F	Guidelines for Preparing a Joint Parking Study	A-20
G	Streetscape Design, Planning and Maintenance Guidelines	A-21
H	[Reserved]	A-30
I	[Reserved]	A-31
J	[Reserved]	A-32
K	Amendments	A-33
L	RUCAOs and PUDs	A-37

ARTICLE 1 GENERAL PROVISIONS

1

Article 1, General Provisions provides the foundation elements and operating mechanisms for the Unified Development Code. It includes establishing purposes, jurisdiction, authority and interpretation. It is most useful to those who will use the code on a daily basis such as City staff or property developers.

UNIFIED DEVELOPMENT CODE

ARTICLE 1 GENERAL PROVISIONS

- 1.1 Overview
- 1.2 Review Authorities
- 1.3 Administration and Enforcement
- 1.4 Interpretation

1.1 OVERVIEW

- 1.1.1 Title
- 1.1.2 Authority and Jurisdiction
- 1.1.3 Purposes
- 1.1.4 Effective Date
- 1.1.5 Severability
- 1.1.6 Amendments
- 1.1.7 Annual Review Requirement

1.1.1 Title

These regulations shall be known as the "Cheyenne Unified Development Code," and may be referred to throughout this Title as "these regulations," "this code," "this Title," or "the UDC." References to the "subdivision standards" (Article 4), "zoning ordinance" (Article 5), "design standards" (Article 6), or "form-based code" (Article 7) may refer to individual articles in these regulations if the context suggests a specific reference.

1.1.2 Authority and Jurisdiction

These regulations are adopted under the authority granted by the Wyoming Statutes, including: Sections 34-12-101 to 34-12-115 (Platting and Dedication); 9-8-101 to 9-8-302 (Land Use Planning Act); 15-1-401 to 15-1-422 (Annexation; Determination of Boundaries; Addition and Exclusion of Land); 15-1-501 to 15-1-512 (Planning – Cities and Towns); 15-1-601 to 15-1-611 (Zoning – Cities and Towns); and all general police powers of the City of Cheyenne, Wyoming.

These regulations are applicable to all incorporated areas of the City of Cheyenne, Wyoming, any official additions to the incorporated boundaries, and where specifically stated and authorized by statute, some areas outside of the incorporated area in the City's Planning Jurisdiction.

1.1.3 Purposes

The purposes of these regulations are to:

- a. Promote the health, safety and the general welfare of the citizens of Cheyenne.
- b. Implement the Comprehensive Plan for the City of Cheyenne, including other official plans, policies and programs developed under the guidance of the Comprehensive Plan.
- c. Create safe and attractive living and working environments.
- d. Preserve and enhance long-term values of property and buildings.
- e. Promote economic vitality in the City.
- f. Guide and facilitate coordinated development and use of land.
- g. Establish standards for zoning districts and for the kinds and classes of buildings within districts that promote the unique character of districts and suitability for particular uses.
- h. Preserve and rehabilitate historic properties in certain districts.
- i. Achieve the Intent and Design Objectives specified in the detailed sections of these regulations.

1.1.4 Effective Date

These regulations are effective from and after the date designated in the official action by the City Council in adopting this Title. This action shall not affect the prior effective date of any standards included in this Title and which were previously adopted under the Cheyenne - Laramie County Subdivision/ Development Standards, the Cheyenne and Laramie County Zoning Ordinance, and the City of Cheyenne Road, Street & Site Planning Design Standards.

1.1.5 Severability

Should any provision of these regulations, or any application of these regulations to persons or circumstances, be declared invalid for any reason by a court of competent jurisdiction, the declaration shall be limited to that provision or specific application directly involved, and shall not affect the validity of other provisions of these regulations as a whole, or the application to other persons or circumstances.

1.1.6 Amendments

This Title may be added to, changed, modified or repealed. All proposals for amendments shall be referred to the Planning Commission and processed according to the procedures and criteria in Article 2.

1.1.7. Annual Review Requirement

A summary report of any formal issues and concerns regarding this code and received by Staff over the course of the previous year shall be brought before the Planning Commission for acknowledgement on an annual basis each February. The Planning Commission may direct action, additional research, or investigation into elements of this code that may need modification. This does not preclude modifications to the code being made at other times as may be initiated under 1.1.6 but provides for an opportunity for review to keep the code current and ensure its viability and responsiveness over time. Formal concerns may be reported using the form provided by the Department.

1.2 REVIEW AUTHORITIES

- 1.2.1 Summary Table
- 1.2.2 Staff
- 1.2.3 Planning Commission
- 1.2.4 City Council
- 1.2.5 Board of Adjustment

1.2.1 Summary Table

Table 1-1 provides a summary of the review authorities for these regulations, and the applications and procedures of the review authorities. Specific procedures and criteria for these applications are included in Article 2.

TABLE 1-1: SUMMARY OF REVIEW AUTHORITY									
Application Type	Pre-app meeting	N'hood meeting	Review Body				Notice		
			Staff	PC	CC	BoA	Pub.	Mail	Post
Text Amendment			R	R/H	D/H		<input checked="" type="checkbox"/>		
Map Amendment ("rezoning")	<input type="radio"/>		R	R/H	D/H		<input checked="" type="checkbox"/>	<input checked="" type="checkbox"/>	<input checked="" type="checkbox"/>
Subdivision – Administrative Plat	<input checked="" type="checkbox"/>		D	A*					<input checked="" type="checkbox"/>
Subdivision – Preliminary Plat	<input type="radio"/>		R	R	D		<input checked="" type="checkbox"/>		<input checked="" type="checkbox"/>
Subdivision – Final Plat	<input type="radio"/>		R	R	D		<input checked="" type="checkbox"/>		<input checked="" type="checkbox"/>
Site Plan Review	<input type="radio"/>		D			A			<input checked="" type="checkbox"/>
Master Development Plan / Regulating Plan	<input checked="" type="checkbox"/>	<input checked="" type="checkbox"/>	R	R/H	D		<input checked="" type="checkbox"/>	<input checked="" type="checkbox"/>	<input checked="" type="checkbox"/>
Administrative Use Approval	<input checked="" type="checkbox"/>		D			A			<input checked="" type="checkbox"/>
Conditional Use Approval	<input type="radio"/>		R			D/H	<input checked="" type="checkbox"/>	<input checked="" type="checkbox"/>	<input checked="" type="checkbox"/>
Temporary Use Approval	<input checked="" type="checkbox"/>		D			A			
Administrative Adjustment	<input checked="" type="checkbox"/>		D			A			
Appeal of Administrative Decision	<input type="radio"/>					D/H		<input checked="" type="checkbox"/>	
Variance	<input type="radio"/>		R			D/H	<input checked="" type="checkbox"/>	<input checked="" type="checkbox"/>	<input checked="" type="checkbox"/>
Subdivision Standard Waiver	<input checked="" type="checkbox"/>		D	A	A				
Annexation	<input type="radio"/>		R		D		<input checked="" type="checkbox"/>	<input checked="" type="checkbox"/>	<input checked="" type="checkbox"/>
Street Vacation	<input type="radio"/>		R	R	D		<input checked="" type="checkbox"/>	<input checked="" type="checkbox"/>	<input checked="" type="checkbox"/>

R = Recommendation
 D = Decision
 A = Appeal
 H = Public Hearing
 PC = Planning Commission

CC = City Council
 BoA = Board of Adjustments
 = Required
 = Recommended or Optional
 * May be appealed as a preliminary plat application to Planning Commission.

1.2.2 Staff

a. **Planning Services Director.** The Planning Services Director (Director) shall be the person appointed by the Mayor to head the Planning and Development Department. References to the Director shall include his or her designee, or any other administrative committees or groups established by the Director in exercising discretion on the operation and administration of the Department. The Director is the principal interpretation and enforcement officer under these regulations, and may consult with any other Department or relevant outside agencies when exercising this authority. In addition to other general administrative duties, the Director shall have the following review and decision-making responsibilities under these regulations:

1. **Review Authority.** The Director shall have the authority to review and make recommendations for the following:
 - a. Text Amendments
 - b. Zoning Map Amendments
 - c. Subdivision – Preliminary Plats
 - d. Subdivision – Final Plats
 - e. Master Development Plan / Regulation Plan
 - f. Conditional Use Permits
 - g. Variances
2. **Decision-making Authority.** The Director shall have the authority to review and make the final decision on the following, all of which may be appealed in accordance with the procedures in Article 2:
 - a. Subdivision - Administrative Plats
 - b. Site Plans
 - c. Administrative Use Approvals, where specifically indicated in these regulations
 - d. Temporary Use Approvals
 - e. Administrative Adjustments
 - f. All other administrative decisions specifically mentioned or necessarily implied by these regulations
3. **Official Application Requirements.** The Director shall have the authority to make all official application requirements for submittal of formal applications under the review processes in Article 2. The Director shall have the authority to require all information that is reasonably necessary to evaluate the application

according to the standards and criteria of these regulations. All official application requirements shall be on file with the Department and available to the public on request. The official application requirements may be reviewed and amended by the Planning Commission or City Council in their discretion, and may be amended by the Director from time to time. Major amendments proposed by the Director shall be reviewed by Planning Commission and acknowledged by City Council. A major amendment may include new studies or significantly altering the timing of construction or other technical products. Any amendment to the official application requirements shall not impact any application that has formally been submitted, however the Planning Commission and City Council have the authority to require additional information in the review of applications as provided in these regulations.

- b. **City Engineer.** The City Engineer shall be the person serving in the position of City Engineer and responsible for reviewing the engineering design, construction, operation and maintenance of all public improvements specified under these regulations. In addition to other administrative duties, the City Engineer shall have the following review and decision-making responsibilities under these regulations:
 1. **Review Authority.** The City Engineer shall have the authority to review and make recommendations on the technical specifications and engineering design of all public improvements, private utilities, and other infrastructure associated with any development application under these regulations.
 2. **Decision-making Authority.** The City Engineer shall have the authority to review and make final decision on the following, to the extent it deals with the engineering design, construction, operation or maintenance of public improvements:
 - a. Subdivision Standard Waivers
 - b. All other administrative decisions specifically mentioned and reasonably implied by these regulations. The City Engineer also makes final approval of processes not described in this code, relating to the processes involved with the submittals for technical design of various required facilities.

ARTICLE 1

GENERAL PROVISIONS

1.2 REVIEW AUTHORITIES

3. **Official Application Requirements.** The City Engineer shall have the authority to require all information that is reasonably necessary to evaluate the application according to the standards and criteria of these regulations.

4. Subdivision – Final Plats
5. Master Development Plan / Regulating Plan
6. Annexation
7. Street Vacations

1.2.3 Planning Commission (Commission)

The Planning Commission is the appointed body of the City responsible for all long-range and comprehensive planning, as well as review, recommendations and decisions on implementation of long-range and comprehensive planning policies. In addition to other general planning authority by statute, local ordinance or charter, or bylaws, the Planning Commission shall have the following responsibilities under these regulations.

- a. **Review Authority.** The Planning Commission shall have the authority to review and make recommendations for the following:
 1. Text Amendments
 2. Zoning Map Amendments
 3. Subdivision - Preliminary Plats
 4. Subdivision Final Plats
 5. Master Development Plan / Regulating Plan
 6. Street Vacations
- b. **Appeal Authority.** The Planning Commission shall have the authority to hear appeals of decisions for the following:
 1. Administrative Plats
 2. Subdivision Standard Waivers

1.2.4 City Council (Council)

The City Council is the elected governing body of the City responsible for all legislative decisions. In addition to other general authority, the City Council shall have the following review and decision-making responsibilities under these regulations.

- a. **Decision-Making Authority.** The City Council shall have the authority to review and make the final decision on the following:
 1. Text Amendments
 2. Zoning Map Amendments
 3. Subdivision – Preliminary Plats. The City Council may acknowledge the decision of the Planning Commission, or may elect to review the preliminary plat on its merits and come to its own decision prior to acknowledging the plat.

1.2.5 Board of Adjustment (Board or BoA)

- a. **Establishment.** The Board of Adjustment is the appointed body of the City responsible for appeals and quasi-judicial decisions under the zoning regulations. The Board of Adjustment shall consist of five to seven members each to be appointed for a term of three years. Board members shall be appointed by the Mayor, with the consent of City Council. Any member of the Board of Adjustment may be removed for cause by the City Council upon written charges and after public hearing. Vacancies shall be filled for the unexpired term of any member whose term becomes vacant.
- b. **Meetings.** Meetings of the Board shall be held at the call of the chairman, and at such other times as the Board may determine. The chairman, or in his absence, the acting chairman, may administer oaths and compel the attendance of witnesses. All meetings of the Board shall be open to the public except where specifically provided otherwise by law. The Board shall keep minutes of its proceedings, showing the vote of each member upon each question, or if the member was absent, or failed to vote. The Board shall keep records of its deliberations and other official actions, all of which shall be filed with the Director and shall be a public record.
- c. **Decision-making Authority.** The Board of Adjustment shall have the authority to review and make the final decision on the following:
 1. Variance
 2. Conditional Use Approval
 3. Appeal of an Administrative Decision
- d. **Appeal Authority.** In addition to any other authority granted by statute or local ordinance, the Board of Adjustment shall have the authority to hear appeals and affirm, modify, or over-rule the final decision on the following:
 1. Site Plan
 2. Temporary Use Approval
 3. Administrative Use Approval
 4. Administrative Adjustment

1.3 ADMINISTRATION AND ENFORCEMENT

- 1.3.1 Purpose
- 1.3.2 Compliance Required
- 1.3.3 Responsible Persons
- 1.3.4 Violations
- 1.3.5 Violation Notice
- 1.3.6 Investigatory Powers
- 1.3.7 Penalties
- 1.3.8 Suspension of Permit or License
- 1.3.9 Abatement of Violations
- 1.3.10 Appeals
- 1.3.11 Nonconformances
- 1.3.12 Fees

1.3.1 Purpose

This Section establishes procedures through which the City seeks to ensure compliance with the provisions of this code and obtain corrections for violations of this code. This Section also sets forth the remedies and penalties that apply to violations of this code. The provisions of this Section are intended to encourage the voluntary correction of violations, where possible.

1.3.2 Compliance Required

Compliance with all provisions of this code is required by all persons owning, developing, dividing, managing, using, or occupying land or structures. Failure to comply with a standard, requirement, prohibition or limitation imposed by this code, or the terms or conditions of any permit, approval or authorization granted in accordance with this code, shall constitute a violation of this code punishable as provided in this Section.

1.3.3 Responsible Persons

The owner, tenant or occupant of any land or structure, and an architect, engineer, builder, contractor, agent or any other person who participates in, assists, directs, creates or maintains a situation that constitutes a violation of these regulations, may be held responsible for the violation and be subject to the remedies and penalties set forth in this Section.

1.3.4 Violations

It shall be unlawful for any building, structure, site element or use of land to be constructed, altered, maintained or otherwise initiated in violation of these regulations, or in violation of any amendment, order or decision authorized under these regulations. In addition to any other remedy provided in

these regulations, the City may institute proper actions or proceedings to prevent the unlawful activity or situation. Activities that constitute a violation include, but are not limited to, the following:

- a. Creating, expanding, replacing or changing any nonconformity except in compliance with this code;
- b. Reducing or diminishing the requirements for development, design or dimensional standards below the minimum required by this code;
- c. Increasing the intensity or density of development, except in accordance with the standards of this Code;
- d. Through any act or omission, failing to comply with any other provisions, procedures or standards as required by this code;
- e. Disturbing any landscaped area or vegetation required to be protected or maintained by this code;
- f. Installing, creating, erecting, altering or maintaining any sign without first obtaining the appropriate permits or required development approvals and complying with their terms and conditions;
- g. Failing to remove any sign installed, created, erected or maintained in violation of this code, or for which a previously approved permit has expired.

1.3.5 Violation Notice

The following procedures shall be used in citing violations of these regulations:

- a. The first notice shall be by certified mail or by other provable means of service, which notice shall state that the violation must cease within fourteen (14) calendar days from the date of receipt of the notice. In cases where a health hazard or emergency may exist, or where removal of the violation is deemed imperative by the Director or his or her designated representative, the fourteen (14) day limit may be decreased. The notice may indicate potential penalties for violation.
- b. A final notice shall be by certified mail or by other provable means of service if the violation has not been corrected within the time period set forth in the first notice. The final notice shall indicate the dates and time frames previously provided and shall state that the violation must cease within seven (7) calendar days from the date of receipt of the final notice. Should the violation not cease within seven (7) days of receipt, the matter will be referred to the City Attorney who will act as expeditiously as possible and who may also follow the processes under Section 1.3.8 or 1.3.9.

ARTICLE 1

GENERAL PROVISIONS

1.3 ADMINISTRATION AND ENFORCEMENT

- c. Violations may be cited by the City.
- d. Notification under this section may also be made by placing a violation notice directly on the property if the provisions of this sub-section cannot be accomplished.
- e. The Director may grant one (1) extension of up to thirty (30) days should an extension be requested. Requests must be in writing and signed by the responsible persons. Should the Director approve the extension, a written approval will be sent to the responsible persons and added to the case file.

1.3.6 Investigatory Powers

- a. The Director is authorized to enter upon any property, excluding dwelling units, and at any reasonable time for the purpose of inspecting properties or performing other duties under these regulations.
- b. The City may investigate, and to the extent necessary administer an oath or affirmation, and upon request of any party, may subpoena witnesses, compel own motion, or upon request of any party, may subpoena witnesses, compel their attendance, adduce evidence, and require the production of any matter which is relevant of the investigation, including the existence, description, nature, custody, condition and location of any books, documents or other relevant facts or any other matter reasonably calculated to lead to discovery of admissible evidence.
- c. Upon failure without lawful excuse to obey a subpoena or to give testimony and upon reasonable notice to all persons affected thereby, the City may apply to any district court for an Order compelling compliance.

1.3.7 Penalties

Any person, firm or corporation which fails to comply with or violates any of these regulations shall be subject to any penalties permitted by the Wyoming Statutes authorizing these regulations, or any other remedy available to the City including:

- a. **Injunction.** If any building or structure is erected, constructed, reconstructed, repaired, converted, or any building, structure, or land is used in violation of these regulations, the Director or any adjacent or other property owner who would be damaged by such violation, in addition to other remedies,

may institute an injunction, mandamus, or other appropriate action or proceeding to stop the violation.

- b. **Fine Generally.** Any person, violating any provision of these regulations is guilty of a separate offense for each and every day during any portion of which any violation of any provision of these is committed, continued, or permitted by any such person and shall be punished by a fine of the maximum allowed by the State Statute for each offense. Daily fines may be calculated from the date of first notice to the date of the hearing being scheduled or until date of remedy if remedied prior to a hearing date being established.

- c. **Fine for Misrepresentation of Subdivisions.** Any person who knowingly authorizes, directs or aids in the publication, advertisement, distribution or circulation of any false statement or misrepresentation concerning any subdivision/development for sale, in this or any other state, and every person with knowledge that any such advertisement, prospectus, pamphlet or letter concerning land of any subdivision/development thereto contains any written statement that is false or fraudulent in any material part or who issues, circulates, publishes or distributes the same or who causes the same to be circulated, published or distributed, shall upon conviction be imprisoned for a period not to exceed thirty (30) days or be fined the maximum amount authorized by the Wyoming Statute. Each day of violation constitutes a new offense.

- d. **Suspension of Permit or License.** Violations of these regulations may result in suspending a permit, license, or approval where the terms of the approval are not being met as provided in subsection 1.3.8, below.

- e. **Abatement of Violation.** Violations of these regulations may be abated at the election of the Director. This procedure shall not be the sole remedy available, and the City may enforce these regulations in any manner provided by law as provided in section 1.3.9, below.

- f. **Stay of Fines.** Should a remedy be initiated by the responsible persons or during a public hearing process, a stay of fines may be permitted.

1.3.8 Suspension of Permit or License

Suspension of any City issued permit, license or approval issued in accordance with these regulations or the Municipal

ARTICLE 1

GENERAL PROVISIONS

1.3 ADMINISTRATION AND ENFORCEMENT

Code may be made under the procedures and standards of this Section.

- a. A license, permit or approval shall be suspended if any of the following findings are made:
 - 1. A use or development action upon the parent property has not obtained approvals required by this code;
 - 2. The physical development, use, development option, or subdivision, violates the terms or conditions of the permit or any approval of this code; or
 - 3. The permit, approval, or license was issued on the basis of erroneous or misleading information or misrepresentation.
- b. Rules of Procedure
 - 1. A suspension proceeding shall be governed by the contested case rules adopted by the City.
- c. Process
 - 1. The process shall follow the proceedings of Section 2.92.020 of the Municipal Code of the City of Cheyenne.

1.3.9 Abatement of Violations

Abatement of violations of these regulations shall be made under the procedures and standards of this Section.

- a. A license, permit or approval shall be suspended if any of the following findings are made:
 - 1. Substantial evidence that a violation of this Code does exist; and
 - 2. Sufficient cause to evict or relocate an illegal use or rehabilitate, demolish, remove or repair an illegal development.
- b. Effect
 - 1. If an Order to Abate is issued it shall mean that the land or development is in violation of this Code and the illegal activity shall be discontinued and rehabilitated, repaired, removed, or demolished in the manner and means specifically set forth in the Order to Abate.
- c. Rules of Procedure
 - 1. An abatement proceeding shall be governed by the Wyoming Administrative Procedures Act, W.S. 16-3-107 through -115.

- d. Process
 - 1. Notice to Abate. If a Final Notice has been issued as specified in Section 1.3.5.b and the responsible persons is found to not be in compliance after the timeline specified in the final notice, a notice to abate may be mailed to the landowner stating the date and time the abatement will take place. Notice shall be sent at least fourteen (14) days prior to the abatement.
 - 2. Notice of Hearing to Abate. Should the responsible persons request to appeal the notice to abate after receiving the notice, a notice of a hearing to abate shall be mailed to the landowner stating the date, time, and location of the public hearing by certified mail, return receipt requested and stating the provisions of these regulations being violated. Notice shall be sent at least fourteen (14) days prior to the hearing.
 - 3. Hearing officer conclusion. If, after the conclusion of the hearing, the Officer finds that an Order to Abate shall be issued, the Hearing Officer shall prepare an Order to Abate outlining findings and specifying the nature of the violation, the method of abatement, and the time within which the abatement shall be commenced and completed. The Hearing Officer shall provide the landowner a copy of the Order to Abate, by mail, on the day the order is made.
 - 4. Abatement. The City's right to abate a violation of this Code, as provided in this Section, shall be cumulative to any other remedy provide by law.
- e. Costs of abatement; notice of assessment
 - 1. Upon completion of abatement by the city, the city shall complete a statement of costs. The statement shall include the costs of abatement and any other expenses incurred by the city, plus an administrative fee in the amount of fifty (50) percent of the abatement costs.
 - 2. The city shall send written notice of the city's costs of the abatement to the owner of the property by certified mail, return receipt requested.
 - 3. The city will engage an independent contractor for abatement of a violation, the city is authorized to bill the costs of the abatement plus the administrative fee provided by UDC 1.3.9.e.1, above, to the owner of the property that is the subject of the abatement.

f. Rules of Procedure

1. If an owner or occupant of property to which a statement of costs has been sent fails to pay the costs of abatement within thirty (30) days after notification, the city attorney may file an appropriate lien with the county clerk and ex officio registrar of deeds for Laramie County. The lien shall contain the legal description of the property involved, the amount of the unpaid bill, and a notice that the city claims a lien for its costs of abatement. A lien for abatement costs may be foreclosed in accordance with the laws of the state of Wyoming. In addition, the city may pursue any remedies provided by law including assignment of the claim for costs of abatement to a collection agency.

1.3.10 Appeals

Appeals to the application and enforcement of these regulations shall be allowed by the procedures and criteria in Article 2. In general these regulations provide for the following distinct appeals.

- a. **Administrative Use Approval.** A process to administer the provisions of these regulations in a manner that best achieves the Purposes, Intent and Design Objectives of these regulations, and which may offer relief or alternative compliance to standards. Administrative Use Approvals are administrative decisions and only allowed where specifically identified in the provisions of these regulations, and subject to the procedures and criteria in Article 2.
- b. **Waiver.** A process to decide whether or not to apply a specific standard of the Subdivision Standards in Article 4, or decision to apply an alternative standard in a specific circumstance. Waivers are an administrative decision and only allowed subject to the procedures and criteria identified in Article 2.
- c. **Variance.** A process to decide whether to vary or adjust the strict application of a standard in Articles 5, 6 and 7. Variances are quasi-judicial decisions and allowed subject to the procedures and criteria identified in Article 2.
- d. **Appeal of an Administrative Decision.** A process to decide if any final administrative decision made by an administrative official in the interpretation or enforcement of the standards of this code are correct.

1.3.11 Nonconformances

- a. **Generally.** Within the zoning districts established by this

Title and amendments that may later be adopted, there exist land and uses of land which were lawful before this Title was passed or amended, but which would be affected by the terms of this Title or future amendments. Therefore, it is the intent of this Title to permit these nonconforming uses and conditions to continue, provided that:

1. The continuation of the nonconformance is not detrimental to the public health, safety and welfare;
2. Any future development activity on the site seeks to conform to the code to the extent practical; and
3. All efforts to alleviate or gradually eliminate the undesirable consequences of nonconformances are made. It is further the intent of this Title that these nonconforming uses and conditions shall not be used as grounds for allowing other uses or conditions prohibited elsewhere in the district.

- b. **Nonconforming Structures.** Structures that were legally constructed prior to the adoption or amendment of this code, but which could not be constructed under the terms of this code or subsequent amendment are considered nonconforming structures. A nonconforming structure may continue to exist or expand subject to the following:

1. An extension of a structure, or placement of an accessory building, which does not further encroach upon the violated yard requirement, may be granted upon the approval of the Director, if it is found the extension or placement of structure is not detrimental to the purposes or intent of this Title.
2. If destroyed by fire or other natural disaster, the structure may be restored to its original condition if the restoration is started within one year. A two-year extension may be granted by the Director for a building or structure provided a written request for such extension is received from the building owner prior to the end of the original one-year period.
3. If the structure is determined obsolete or substandard by virtue of any applicable code beyond this Title, and the cost of improvement or restoration exceeds fifty percent of the fair market value of the structure, then the right to maintain the nonconformance shall terminate.

- c. **Nonconforming Uses.** Use of land or buildings that legally existed prior to the adoption or amendment of this code, but which could not be commenced under the terms of this code or subsequent amendment are considered nonconforming uses. A nonconforming use may continue to exist subject to the following:
1. Expansion of a nonconforming use requires Board approval in accordance with the procedures and criteria in Article 2 for conditional uses.
 2. The use may be changed to a lesser nonconforming use, either in extent or intensity, if the Director determines that the impacts of the new use are less than those of the existing nonconforming use. Accommodating the new use shall not increase any other non-conformances that may exist.
 3. If the nonconforming use ceases its operation for a continuous period of one year, it shall not be reopened and the building or structure where such use previously existed shall be used only for a conforming use.
- d. **Nonconforming Lots.** Any platted lots that legally existed prior to the adoption or amendment of this code, but which could not be platted under the terms of this code or subsequent amendment are considered nonconforming lots. A nonconforming lot may continue to exist subject to the following:
1. Lots that existed at the time of enactment of the ordinance codified in this Title that do not meet the minimum area or frontage requirements of the zoning district in which they are located may be used as a building site. If Administrative or Board approval is required for a use on the lot, the lot size may be a factor in determining if the use is appropriate.
- e. **Nonconforming Site Conditions.** Any site condition associated with a conforming use or structure (such as parking, driveways, or other non-structural site characteristic) in existence prior to adoption of these regulations but not in compliance with these regulations or subsequent amendments is considered a nonconforming site condition. Any change in use, expansion of the use, or expansion of the structure associated with the use shall terminate the legal status of the nonconforming site condition, except that in instances where a site plan is required for the proposed development activity, an administrative adjustment may be granted by the Director
- if:
1. The proposed adjustment does not aggravate any other non-conformance that may exist on the site.
 2. The proposed adjustment will not have adverse impacts on adjacent property
 3. The proposed adjustment is the minimum deviation necessary from applicable standards and otherwise meets the intent of the current standards. In determining the minimum deviation necessary the Director shall consider:
 - (a) The degree that the applicable standard has changed from prior standards;
 - (b) The initial investment in the non-conforming site condition and the amount of benefit already received from that investment;
 - (c) The proposed action does not unreasonably extend the useful life of the nonconforming site condition; and
 - (d) The practical or financial feasibility of strict conformance in relation to the proposed investment in new development activity.
- f. **Determination of Nonconforming Rights and Status.** If nonconforming rights are challenged, or if there is a request to expand or continue nonconformances, it shall be the property owner's responsibility to provide proof through business records or other records and data that the nonconformance has not ceased operation and has continued in operation without a one-year lapse. It shall also be the property owner's responsibility to provide proof that the nonconforming use legally existed, or was previously grandfathered, at the time the ordinance codified in this Title was adopted.

1.3.12 Fees

Fees shall be required at the time of filing of any development application and are payable to the City in accordance with the fee schedule adopted by the City Council to defray some or all of the cost of processing land development applications of this Code. The City Council may amend the fee schedule from time-to-time. The fee schedule shall be made available to the public on the City website.

1.4 INTERPRETATION

- 1.4.1 General Interpretation
- 1.4.2 Interpretation of Dimensional Standards
- 1.4.3 Defined Terms
- 1.4.4 Descriptions of Uses of Land and Buildings
- 1.4.5 Interpretation of Zoning Map
- 1.4.6 Interpretation of Comprehensive Plan and Future Land Use Maps
- 1.4.7 Resources, Guides and Industry Standards

1.4.1 General Interpretation

a. **Rules of Construction.** Unless the context clearly indicates otherwise, the following rules of construction shall apply to these regulations:

1. All words shall have the customary dictionary meaning, unless specifically defined in these regulations.
2. The present tense includes the future tense and the future tense includes the present tense.
3. The singular includes the plural and the plural includes the singular.
4. Lists of examples prefaced by “including the following,” “such as,” or other similar preface shall not be construed as exclusive and shall not preclude an interpretation of the list including other similar and non-mentioned examples.
5. A reference to an administrative official shall refer to that official or his or her designee.
6. The term “building,” “structure,” or “premises,” or any similar term, shall be interpreted to include any part of the building, structure, premises or other similar term unless otherwise stated.
7. All references to other local, state, or federal government regulations or guiding documents in these regulations refer to the most current version and citation for those regulations or documents, where such versions are consistent with the purposes, intent, and objectives of these regulations.

8. This code is organized in Articles (i.e. 7.#), Sections (i.e. 7.2.#), and Sub-sections (i.e. 7.2.3), and further divided into sub-sections and headings within the main sub-sections (i.e. a.2.). Any reference to a Sub-section includes all provisions within the main Sub-section, any reference to a Section includes all of the Sub-sections within that Section, and any reference to an Article includes all of the Sections in that Article, unless context clearly indicates otherwise or the circumstances make any specific standard inapplicable.

b. **Graphics, Commentary, and Notes.**

1. Graphics and commentary associated with graphics used in this code are to aid interpretation of the text, unless otherwise specifically stated. In the event of a conflict or ambiguity between a graphic or commentary and the text, the text shall control.
2. Notes to tables shall apply only to the particular provision footnoted, or to the entire table if it is not specifically footnoted to an item in the table, and not as generally applicable rules.

c. **Purposes, Intent and Applicability Statements, and Design Objectives.** This code is developed under a hierarchy of guidance developed according to the Comprehensive Plan. The hierarchy is generally organized as follows, ranging from the most general to the most specific:

1. *Purpose:* refers to the overall purpose of this code;
2. *Intent:* refers to the general planning goals or policy of an article, section or sub-section in this code;
3. *Context:* with respect to each of the zoning districts, context refers to the most appropriate planning or land use category in the Comprehensive Plan in which to apply this particular zoning district;
4. *Applicability:* refers to the applicability of an article, section, or sub-section in this code to certain anticipated development circumstances or land areas;
5. *Design Objectives:* refers to the specific and desired physical result or performance criteria of standards in an article, section or sub-section of this code; and

6. *Review Criteria:* refers to a list of considerations that review bodies use to determine if applications meet the purpose, intent, applicability, and design objectives of these regulations.

This hierarchy should be used to guide consistent interpretation of the code, and to guide all discretionary approvals or relief authorized under this code.

- d. **Computations of Time.** Unless specifically stated in individual sections, wherever these regulations state a time period, it shall be interpreted as follows:
1. The day of the act, event, or other means which commences the time period shall not be counted.
 2. The last day of the time period shall be included in the time period, unless it is a Saturday, Sunday, or legal City holiday, in which case the next working day shall end the time period.
 3. Whenever the time period is expressed to require a formal submittal to the City, the time period shall end at 5:00 P.M. on the last day of the time period.
 4. Any time period expressed in years shall include a full calendar year from the act, event or other means which commences the time period.
- e. **Conflicts.** In case of a conflict between these regulations or any part of these regulations, and any part of any other existing or future adopted ordinance of Cheyenne, Wyoming, the more restrictive provision in all cases shall apply. In determining which regulation is "more restrictive" the Director shall determine which one most closely follows the policies, strategies and principles of the Comprehensive Plan.

1.4.2 Interpretation of Dimensional Standards

Dimensional standards in these regulations shall be interpreted according to the following rules and guidance:

- a. **Build-to Line.** The line specified as a distance from a lot line at which a building line shall be located within an accuracy of one foot, sometimes expressed as a maximum "setback line." In cases where setback lines are listed as a range indicating a minimum and a maximum setback, the range shall be interpreted as a build-to line at or within such distance a building line shall be established.

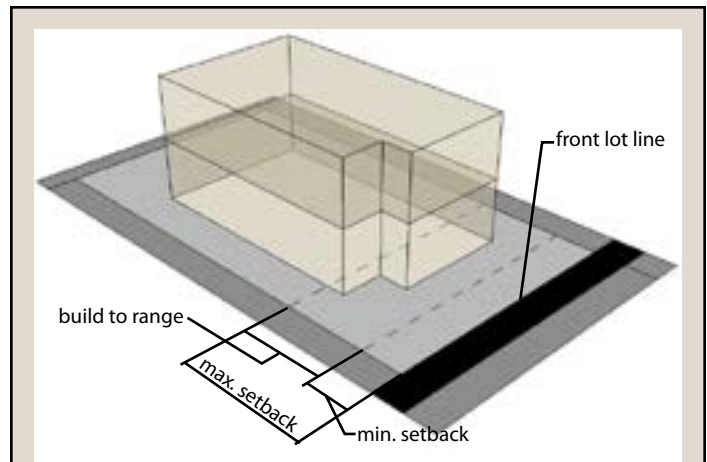

Figure 1-1: Build-to Range

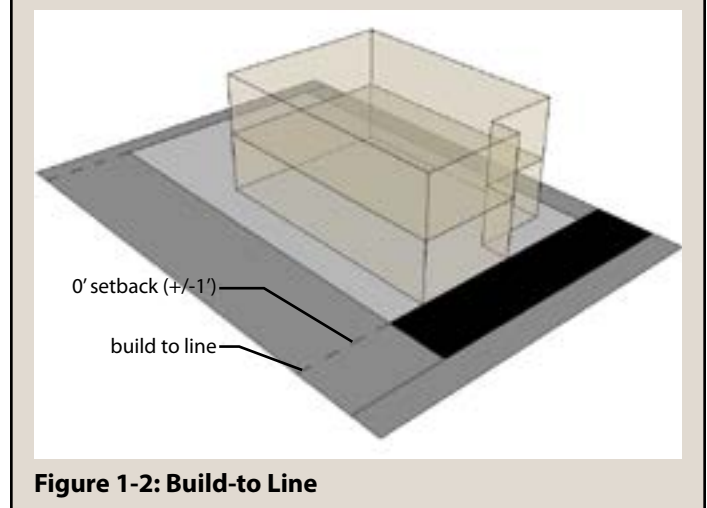

Figure 1-2: Build-to Line

- b. **Building Envelope.** The horizontal area of a lot enclosed by the front setback line or build-to line, side setback lines, and rear setback line.
- c. **Building Height.** Where building height is expressed in feet, the interpretation of this sub-section shall apply [See also "Story"]. The vertical distance measured from the average elevation of the finished lot grade at the front building line to:
1. The highest point of the roof deck in the case of a flat roof;
 2. The deck line of a mansard roof; or
 3. The average height between the plate and ridge of a gable, hip, or gambrel roof.

The height limitations of this Title, with the exception of the airport height restrictions and unless specified otherwise, shall not apply to church spires, belfries, cupolas, domes not intended for human occupancy, flag poles, light poles, monuments, water towers, transmission towers, smokestacks, chimneys, derricks, antennas and aerials.

- d. **Building Line.** The actual line at which the forward most part of a building is constructed, including the extension of that line to the edge of the lot, or beyond if context so indicates.
- e. **Floor Area.** The sum of the actual gross horizontal area of all floors, mezzanine space and interior balconies located at or above the established grade of the lowest abutting street, excluding:
 1. Attic space having less than 7' of head room, and which is not allocated in a permitted half story;
 2. Any interior space devoted to off-street parking or loading; and
 3. A utility room or furnace room.
- f. **Fractions.** When calculations result in fractions, the results shall be rounded as follows:
 1. **Minimum Requirements.** When a regulation is expressed in terms of a minimum requirement, any fractional result shall be rounded up to the next consecutive whole number. For example, if a minimum requirement of one tree for every 30' is applied to a 40' strip, the resulting fraction of 1.33 shall be rounded up to 2 required trees.
 2. **Maximum Amounts.** When a regulation is expressed in terms of a maximum amount, any fractional result shall be rounded down to the next lower whole number. For example, if a maximum of one dwelling unit for every 3,000 square feet is applied to an 8,000 square-foot site, the resulting fraction of 2.67 shall be rounded down to 2 dwelling units.
- g. **Lot.** The following shall be used in interpreting lot dimensional standards:
 1. **Lot area.** The minimum required area of a horizontal plane bounded by the vertical planes through front, rear and side lot lines.

2. **Lot, corner.** A lot abutting upon two or more streets at their intersection or upon two parts of a street which forms an interior angle of less than 135 degrees.
3. **Lot, double frontage.** A lot abutting two (2) streets which do not intersect at the boundaries of the lot.
4. **Lot, triple frontage.** A lot having a frontage on three (3) intersecting streets.
5. **Lot, interior.** A lot other than a corner lot.
6. **Lot depth.** The horizontal distance between the front and rear lot lines measured at right angles to the front right-of-way lines. Where the front and rear lines are not approximately parallel, the lot depth shall be the average when measured from at least three different points along the front lot line, including the two corners at the front lot line.
7. **Lot frontage.** The horizontal distance between side lot lines, measured at the front lot line. Where the front lot line abuts a curved right-of-way, the lot frontage requirement may be applied at the front building line for purposes of regulating the dimensions of lots. See Figure 1-4.
8. **Lot line, front.** The lot line contiguous to the right-of-way line. On a corner lot, the front lot line is presumed to be the lot line along the street on which the lot has the least dimension. An exception may be made for a corner lot whose longer street-side lot line is clearly the primary street and where the orientation of the lot and buildings should face that street, based on the context and orientation of surrounding lots.

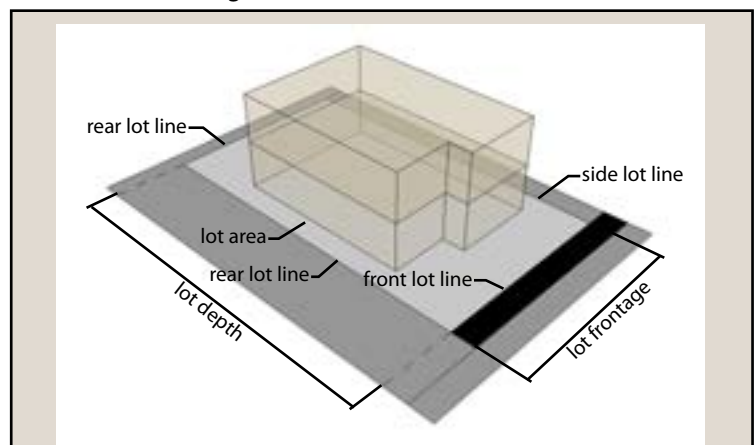

Figure 1-3: Lot Elements

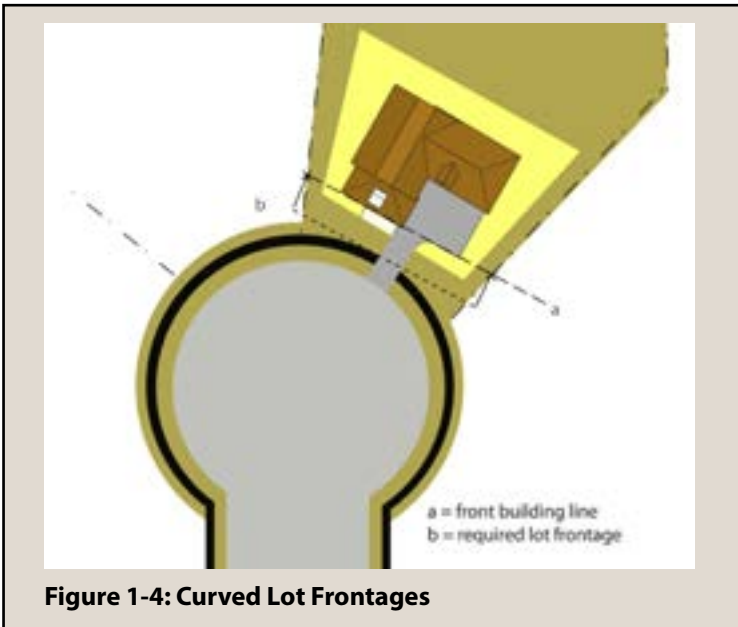

Figure 1-4: Curved Lot Frontages

2. *Accessory building coverage.* The percentage of the lot or other specified dimension covered by an accessory building.
3. *Total Lot Coverage.* The portion of the lot covered by the principal building, accessory building, and any structure or constructed element which impedes infiltration of stormwater into the ground or disrupts vegetated surfaces. For purposes of lot coverage standards, structures or constructed elements that allow some infiltration, such as decks, patios and driveways, porous pavers or concrete, or other elements that disturb or compact permeable ground cover shall be counted towards the total surface coverage. Required formal open spaces such as Plazas, Courtyards or Patios may be excluded from the coverage calculation when they are designed to infiltrate all run-off within the open space or site.

9. *Lot line, rear.* Any lot line opposite to, parallel or nearly parallel with, and most distant from the front lot line. In the case of a triangular lot, or other similarly irregular shaped lots, where no lot line is nearly parallel with the front lot line, the rear lot line shall be interpreted as a line 10' in length, entirely within the lot, parallel to and at a maximum distance from the front lot line.

10. *Lot line, side.* Any lot line other than a front or rear lot line.

h. **Lot coverage.** The maximum allowed coverage of a lot. When measuring lot coverage, the following three measures shall apply:

1. *Building coverage, or principal building coverage.* The percentage of the lot or other specified dimension covered by the principal building excluding the following:
 - (a) Eaves or bays projecting less than 3' from a building;
 - (b) Trellises and similar structures which do not have solid roofs;
 - (c) The portion of any uncovered and unenclosed deck, porch, landing, balcony, planter or stairway; and
 - (d) Accessory buildings.

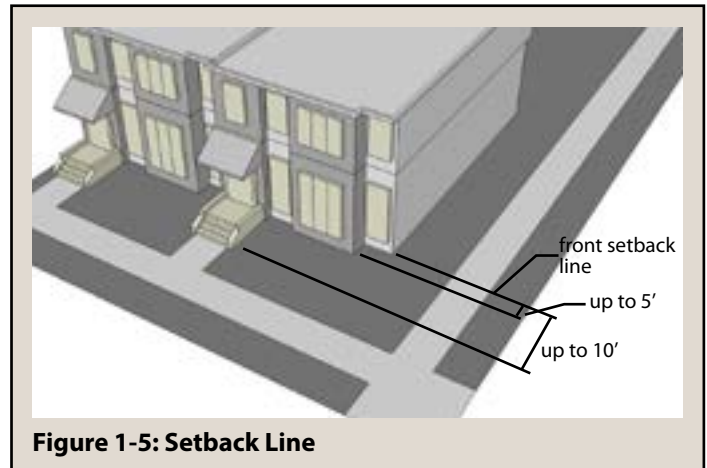

Figure 1-5: Setback Line

- i. **Setback line.** A line that is the required minimum distance from any lot line and establishes the area on the lot within which buildings or structures shall not be built. In cases where setback lines are listed as a range indicating a minimum and a maximum setback, the range shall be interpreted as a "build-to line" at or within such distance a building line shall be established. Exceptions are described in Residential Design Standards, Section 6.6.

j. **Sign Area.** The following shall be used in interpreting dimensional standards for signs:

1. **Free-standing Signs.** The area of the sign shall be computed by the entire area of the face of the structure, cabinet or module enclosed by the border of the frame.

2. **Wall or window mounted Signs.** The area of the sign shall be computed by means of the smallest single and continuous perimeter of any standard geometric figure which encloses the outer limits of the writing, emblem or other display. Gaps in writing, emblems or other display which are greater than 25% of the sign area, when using the same single continuous perimeter above, may be subtracted from the calculation of the sign area.

3. Embellishments such as pole covers, framing, decorative roofing and support structures shall not be included in the area of the measurement if they contain no writing, emblem or other display.

4. Where the sign faces of a double-faced sign are no more than 3' apart at any location, only one face will be measured in computing sign area. If the two faces of a double-faced sign are of unequal area, the area of the sign will be the area of the larger face. In all other cases, the areas of all faces of a multi-faced sign or the surface area of objects will be added together to compute the area of the sign.

5. Sign height is measured from the lowest point of the ground directly below the sign to the highest point on the sign or sign structure.

6. Sign clearance is measured from the highest point of the ground directly below the sign to the lowest point on the sign structure enclosing the sign face.

k. **Story.** Where building height is expressed as a "story(ies)," the interpretation in this section shall apply. Where building height is expressed as both a maximum height in feet and a maximum height in stories, both shall apply and whichever results in the more restrictive interpretation shall be the maximum building height. "Story" shall be interpreted as follows:

1. **Story.** The portion of a building included between the surface of any floor and the surface of the floor next above it, or if there is no floor above it, then the space between the floor and the ceiling next above it or, where there is not a ceiling, to the top of the roof rafters.

a. Stories shall begin at the first floor level that is between 3' above finished grade and 4' below grade.

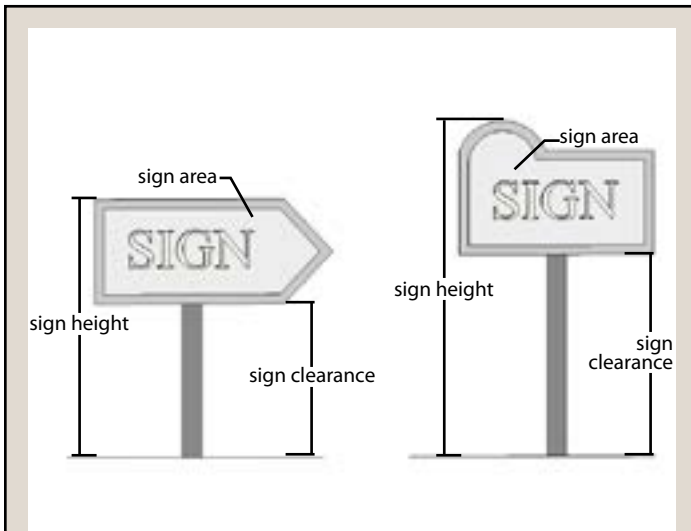

Figure 1-6: Free-standing Signs



Figure 1-7: Wall or Window Mounted Sign

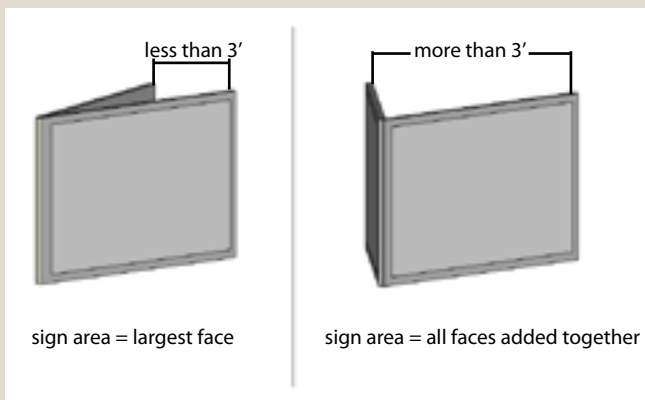

Figure 1-8: Double-faced Sign

- b. The minimum story shall be 9' and the maximum story shall be 14', except that the height of the first story may be as high as 20' for all non-residential buildings that are 2 stories or more.
 - c. *Exception:* Where ground floor manufacturing uses, or warehouse retail is allowed in the zoning district, buildings for those uses shall have no limit on the first story and the maximum building height expressed in feet shall control.
- 2 *Half-story.* A space under a sloping roof that has the line of intersection of the roof and the exterior wall supporting the roof not more than 3' above the floor level, and in which space the possible floor area with head room of 6' or more occupies between 30% and 70% of the total floor area of the story directly beneath.
- i. **Wall plane.** Any plane of continuous vertical, horizontal, or angled or inclined orientation which represents the exterior surface of a building or structure and which is not off-set by projections or recessions of at least 18 inches. Greater required off-sets and required total area of off-sets for wall planes may be specified in the context of these regulations.

1.4.3 Defined Terms

All words and phrases shall have their ordinary and customary meanings unless the context of the word or phrase indicates otherwise. The following terms shall have the meaning given below, unless the context of the use of the term clearly indicates otherwise based on the Purposes, Intent, Design Objective or other guidance associated with its use in a particular section.

Abutting. A description of proximity where two elements share a common boundary.

Access Point. A driveway, internal access street or similar vehicular entrance or exit to the interior of a block, lot or parcel from a street.

Accessory Use. A subordinate use, clearly incidental and related to the principal use and located on the same property.

Activity Center. Places where economic and social activity are focused. In addition, where the code specifically references PlanCheyenne or references specific types of activity centers described in PlanCheyenne the additional guidance in the Plan may be used to determine the context or applicability of a particular standard.

Adjacent. A description of the proximity of two elements which includes abutting and any surrounding vicinity where the impacts described could be reasonably assumed to extend.

Alley. A low capacity, low speed and minor street or access way typically located on the rear or side of properties and used for access to parking, service areas, accessory buildings or easements and not intended for through traffic.

Antenna. Any exterior transmitting or receiving communication device mounted on a tower, building or structure and used in communications that radiate or capture electromagnetic waves, digital signals, analog signals, radio frequencies (excluding radar signals), wireless telecommunications signals or other communication signals.

Appeal. A written request for a review of any final action or decision allowed by the provisions of this Title.

Applicant. Any person(s), firm, corporation or entity requesting permission or desiring to officially apply for any action regulated by this Title.

Average Daily Traffic (ADT). The total volume of vehicles during a given time period (in whole days greater than one day and less than one year) divided by the number of days in that time period.

Awning. A shelter constructed of non-rigid materials along windows and sidewalks at the first story of a building, and mounted on a supporting framework projecting from and supported by the exterior wall of a building.

Base Flood Elevation. The elevation of the flood having a one percent chance of being equaled or exceeded in any given year.

Berm. A mound of earth designed to provide a screen.

Best Management Practice. A technique, process, activity, or structure used to reduce pollutant discharges in stormwater. BMPs include source control practices (non-structural BMPs) and engineered structures designed to treat runoff. BMPs are most effective when used in combination and selected and designed based on site-specific characteristics.

Bicycle Route. A portion of a system of bikeways designated by appropriate route markers which can be a bicycle trail or bikeway.

Bicycle Trail. A trail or path separated from motor vehicles and designated exclusively for bicycles or shared by bicycles and pedestrians.

ARTICLE 1

GENERAL PROVISIONS

1.4 INTERPRETATION

Bikeway. A street designed to incorporate bicycle travel through either shared vehicle / bicycle lanes or designated bicycle lanes.

Billboard. A sign structure advertising an establishment, a message, merchandise, service or entertainment which is not located, sold, produced, manufactured or furnished at the property on which the sign is located. Billboard includes Digital Billboard as defined in this code.

Blinking. A form of flashing where the pattern of sudden illumination changes occurs with more than 2 on-off cycles per second.

Block. An area of land that is entirely bounded by streets or other boundary permitted by these regulations where streets are not appropriate based on the context.

Block Frontage. The side or sides of a block that the majority of the lots or tracts face.

BMP Maintenance. Routinely scheduled activities, as well as non-routine repairs that may be required after large storms, or as a result of other unforeseen problems, as necessary to ensure proper BMP function.

Building. Any structure used or intended for supporting or sheltering any use or occupancy.

Building, Accessory. A detached, subordinate structure, the use of which is clearly incidental and related to that of the principal building or use of the land, and which is located on the same property as that of the principal structure or use.

Building, Attached. A building having one or more party walls in common with an adjacent building.

Building, Detached. A building having no common wall or structural attachment with another building.

Building, Existing. A building erected prior to the adoption of the ordinance codified in this Title, or prior to the effective date of a provision in this Title, whichever is earlier, or one for which a building permit has been issued, or erected in accordance with this code after its adoption.

Building, Nonconforming. A building existing or one for which a building permit has been issued at the time of the adoption of this code which does not comply with the regulations of the zoning district in which the building is located.

Building, Principal. A building in which is conducted the main or principal use of the property on which the building is situated.

Canopy. A shelter constructed of rigid materials covered with fabric, metal or other material, along windows and sidewalks at the first story of a building, and projecting from the exterior wall, which may be freestanding or supported by a building at one or more points and by columns or posts embedded in the ground at other points.

Caretaker Unit. One or more living quarters or lodging facilities located within a non-residential building for the use of employees of the use. A Caretaker Unit shall not be considered a 'residential use' or 'residential unit' for the purposes of this code but shall be considered part of the non-residential square footage for the purposes of the code. The combined square footage of all Caretaker Units shall not comprise more than ten (10) percent of the principal use's building square footage (should dwelling area exceed this amount, the living area shall be determined to be a "Mixed-use Dwelling" and a residential use for the purposes of this code). A Caretaker Unit is allowed as part of the approval of the principal use without any more restrictive approval process than that warranted for the principal use.

Certificate of Compliance. A certificate issued by the Development Office which indicates that the site plan requirements have been met.

Changeable Sign. A sign whose informational content can be changed or altered by manual, electric, electromechanical or electronic means. Changeable signs do not include Digital Billboards as defined in this code.

Change of Use. Change of use constitutes at least one of the following:

1. The proposed use is appreciably different than the current use;
2. There is an increase in the size of the existing building or extent of the use of the land;
3. The use is permitted in the zoning district in which the use is located, but requires more parking than the previous use;
4. The number of vehicle trips generated by the new use is or will be greater than the number of vehicle trips generated by the previous use as determined by the Institute of Transportation Engineers Trip Generation, latest edition;
5. The amount of stormwater runoff or impervious (to drainage) surface area will be increased with the new use.

Channel. A natural or artificial watercourse with a definite bed and banks that conveys continuously or periodically flowing water. Interchangeable terms include creek, drainageway, river, stream, and watercourse.

City Engineer. The City of Cheyenne City Engineer, his designated representative or the City Engineering Department.

Comprehensive Plan. The general plan for land use, transportation, utilities, annexation, and community facilities prepared and maintained by the Commission, and any other more specific plan, program or policy prepared under the guidance of that plan.

Construction, New. Structures for which the construction commenced on or after the effective date of the ordinance codified in this Title.

Construction, Start of. The first placement of permanent construction of a structure (other than a manufactured home), such as the excavation of footings or foundations, or the pouring of slabs or foundations. Permanent construction does not include land preparation, such as clearing, grading and filling, nor does it include the installation of streets and/or sidewalks. For a structure (other than a manufactured home) without a basement or poured footings, the "start of construction" includes the first permanent framing or assembly of the structure or any part thereof on its piling or foundation. For manufactured home not within a manufactured home park or subdivision, "start of construction" means the affixing of the manufactured home to its permanent site. For manufactured home within manufactured home parks or manufactured home subdivisions, "start of construction" is the date on which the structure is to be affixed.

Corner lot. See "Lot, corner."

Crosswalk. Any portion of a roadway distinctly indicated for pedestrian crossing.

Cul-de-sac. A short dead-end street terminating with a vehicular turn-around area.

Curb Radii. The curved or flared portion of a street curb at driveway approaches or intersections.

Decorative Fence. A fence constructed out of materials such as wood, stone, or metal, or a combination thereof, primarily for aesthetic purposes to enhance the appearance of a property and generally not obstructing the visibility into or out of a property. A decorative fence shall not include chain link, wire, snow fences, or a standard wooden or vinyl privacy fences

Detention. The temporary storage of storm runoff in a stormwater management facility with the goals of controlling peak discharge rates and providing gravity settling of pollutants.

Detention Facility. A detention basin or alternative structure designed for the purpose of temporary storage of stream flow or surface runoff and gradual release of stored water at controlled rates.

Developer. The owner of land proposed for development, or the owner's authorized representative, or any person who causes the following to take place either directly or indirectly: division of property for the purpose of development; sells, leases or develops property, or offers or advertises or otherwise engages in business for the same; or has control or is controlled in such a way to have influence in any of the above.

Development. Any man-made change to real estate, including, but not limited to, the construction of buildings or other structures, mining, dredging, filling, grading, paving, excavation or drilling.

Development Footprint. The development footprint is the total land area that is permanently affected by development activities, and includes buildings, structures, hardscape, utilities, roads and parking areas, maneuvering areas, storage areas, areas associated with the use on the property, and areas cleared of natural vegetation and topsoil.

Digital Billboard. A billboard displaying static images controlled by electronic communications.

Dissolve. A transition between digital messages that is achieved with varying light intensity and where the first message gradually appears to dissipate and loses legibility simultaneous to the gradual appearance and legibility of the subsequent message.

Double frontage lot. See "Lot, double frontage."

Drive-in or Drive-up Facility. A portion of an establishment designed for retail or service to persons in automobiles, including a driveway approach, order facilities, signs and delivery windows.

Driveway. A vehicle access way located on private property.

Driveway Approach. A constructed vehicle access point within the right-of-way between the roadway and the adjacent property line.

Dwelling Unit. One or more rooms which are intended for human occupancy as a place of residence with facilities for living, cooking and eating for one family unit, manifesting around one single kitchen, excluding wet bars with no stove or range, and one single laundry facility. Cooking facilities and other accommodations, such as laundry, should be accessible to all occupants of the dwelling through internally connected spaces.

Easement. A permanent or temporary grant of right by a property owner to the public, a corporation or other person(s) for the use of a strip or parcel of land for specified purposes. Ownership shall remain with the property owner.

Electrical Sign. A sign or sign structure in which electrical wiring, connections or fixtures are used. Electrical sign does not include a digital billboard as defined in this section.

Fade. A transition between static message displays that is achieved with varying light intensity and where the first message gradually loses light intensity to the point of not being legible and the subsequent message gradually increases intensity to the point of legibility.

Family Unit. One or more persons who are related by blood, marriage, domestic partnership or legal adoption living together as a single household; or a group of not more than four (4) persons not related by blood, marriage, domestic partnership or legal adoption, living together as a single household.

Fence. A man-made partition, structure, wall or a gate erected as a dividing marker, barrier, enclosure or screening device.

Flag. A sign made of fabric or other non-rigid material with no enclosing framework containing distinctive colors, patterns, or symbols, used as identification for or a symbol of a government, political subdivision, or other entity.

Flashing. A pattern of changing light illumination where the sign illumination alternates suddenly between fully illuminated and fully non-illuminated in a time frame of less than 4 seconds.

Floor Area Ratio (FAR). The total square feet of the building divided by the total square feet of the lot the building is located on.

Foot Candle. A unit of illuminance equal to 1 lumen, uniformly incident upon an area of 1 square foot.

Freeboard. A factor of safety usually expressed in feet above a flood level for purposes of floodplain management. Freeboard

compensates for the many unknown factors that could contribute to flood heights greater than the height calculated for the design flood.

Functional turf grass. An area of living turf grass or lawn that is used regularly for human recreational purposes or domestic animal use. Functional turf grass or lawns include Kentucky bluegrasses, fescues, or similar sod-forming grasses requiring ½ inch or more of supplemental watering per week during hot, dry periods.

Garage. A building or portions of a building for the storage of automobiles or other property, accessory to the principle use of the site.

Greenway. A linear open space established along either a natural corridor, such as a stream valley, or overland along a road or railroad right-of-way converted to recreational use; a natural or landscaped course prepared for pedestrian or bicycle passage; certain designated strips or linear parks and open spaces connected and designated by the City as part of the Greenway System.

Height. When referring to a tower or other structure, height is the distance measured from the finished grade of the parcel to the highest point on the tower or other structure, including the base pad and any antenna.

High-power Transmission Lines. Transmission lines which carry sixty-nine thousand (69,000) volts or more.

Immediate. A transition between static message displays that is achieved in 2 seconds or less.

Impoundment Yard. A fenced yard or enclosed area where storage of vehicles seized by, and in the custody of, a government agency, are stored for retrieval by the vehicle owner or are sold by proper means by the agency.

Improvement. Buildings, structures and all facilities of a public nature indented for public use – including streets, sidewalks, curbs, gutters, alleys and other public ways, parks, recreational facilities, water, sewage, solid waste disposal and other sanitary systems and facilities.

Infill Development. For commercial or residential parcels shall be defined by the following criteria:

1. One parcel surrounded by urban development on at least three sides (does not have to be directly adjacent to); and
2. Served by existing underground sewer and water utilities.

Infiltration. The process of percolating stormwater into the subsoil.

Interior lot. See "Lot, interior."

Intermittent. A pattern of changing light intensity, other than that achieved with immediate, fade or dissolve transitions, where any message remains static for over 4 seconds.

Intersection. The junction of two streets.

Land Disturbance Activity. Grading, digging, cutting, scraping, or excavating of soil, placement of fill materials, paving, construction, substantial removal of vegetation, or any activity which bares soil or rock or involves the diversion or piping of any natural or man-made watercourse.

Landscape Points System. The point system used for determining the minimum vegetation requirement.

Landscaped Setback. The minimum required landscaping area on private or government-owned property which is adjacent to a property line common to a street right-of-way. Driveways and sidewalks to afford required access shall be allowed to interrupt this required space.

Landscape, Street Tree Area. The landscaped area between property line and the street, within the right-of-way.

Landscaping. Any combination of living plants, such as trees, shrubs, vines, ground covers, flowers or grass; natural features, such as rock, stone, bark chips or shavings; and structural features, including, but not limited to, fountains, reflecting pools, outside art work, screen walls, fences or benches.

Landscaping, Internal. That area that lies within the property lines not covered by buildings, parking, outside storage, sidewalks and driveways.

Landscaping, Xeriscape. A water-saving landscape design that limits turf areas, utilizes mulches, efficient irrigation (often drip or subsurface) and use of native or drought-tolerant plant materials. When done properly, it is as lush and green as traditional landscapes, but has the benefits of lower water use and less maintenance after establishment.

Loading Space. An on- or off-street space for the standing, loading, and unloading of vehicles, people or articles.

Lot. A designated unit of land established by a plat or otherwise as permitted by law, for the transfer of ownership or to be used, developed, or built upon, whether immediate or future.

Low Impact Development (LID). An approach to land development (or redevelopment) that works with nature to manage stormwater as close to its source as possible. LID emphasizes conservation and use of on-site natural features to protect water quality. This approach implements engineered small-scale hydrologic controls to mimic the pre-development hydrologic regime of watersheds through infiltrating, filtering, storing, evaporating, and detaining runoff. The term Green Infrastructure may also be used.

Major Drainageway. Any drainage flow path mapped with an area of special flood hazard on the Flood Insurance Rate Map (FIRM).

Manufactured Home. A structure transportable in one or more sections which, in the traveling mode, is 8 body feet or more in width or 40 body feet or more in length or, when erected on site, is 320 or more square feet, and which is built on a permanent chassis and designed to be used as a dwelling with or without a permanent foundation when connected to the required utilities, and includes the plumbing, heating, air-conditioning and electrical systems contained therein; except that such term shall include any structure which meets all the requirements of this paragraph except the size requirements and with respect to which the manufacturer voluntarily files a certification required by the secretary (HUD) and complies with the standards established by HUD. For manufactured homes built prior to June 15, 1976, a label certifying compliance to the standard for mobile homes, NFPA 501, ANSI 119.1, in effect at the time of manufacture is required.

Moving Light. The physical change in position of any visible illumination source while lighted or the simulation of movement achieves with a pattern of sequentially illuminating visible illumination sources within close proximity to each other.

MS4 Permit. A state or federal stormwater discharge permit to regulate discharges from municipal separate storm sewer systems (MS4s) for compliance with Clean Water Act regulations; used interchangeably with the term National Pollutant Discharge Elimination System (NPDES) permit and collectively referred to as federal stormwater discharge permit.

Nonfunctional turf grass. An area of living turf grass or lawn that is not used regularly for human recreational purposes or domestic animal use. Nonfunctional turf grass or lawns include Kentucky bluegrasses, fescues, or similar sod-forming grasses requiring ½ inch or more of supplemental watering per week during hot, dry periods.

ARTICLE 1

GENERAL PROVISIONS

1.4 INTERPRETATION

Nonpoint Source Pollution. Pollution from any source other than from any discernible, confined, and discrete conveyances, and shall include, but not be limited to, pollutants from agricultural, silvicultural, mining, construction, subsurface disposal and urban runoff sources.

Off-premise Sign. Any sign not identified as a "Billboard" and which is used for the purpose of displaying, advertising, identifying, or directing attention to a business, service, activity or place, including products or services sold or offered for sale, on premises other than the premises where such sign is displayed.

Open Space Systems. A system of various types of outdoor space, designed to function as aesthetic, recreation, and ecological support for development. Elements of the open space system can include private, common, or public open spaces.

Owner. The owner of record of a parcel of land, as recorded in the office of the county clerk.

Parapet. The architectural enhancement in the design of the façade that extends ornamental details above a roof line to the extent necessary to screen the roof and roof-top equipment.

Parcel. A contiguous unit of land owned and recorded as the property of the same persons or controlled by a single entity.

Parking Lot. An area other than a street or alley designated for the parking of five or more motor vehicles.

Parking Space. A space specially designed for the parking of a motor vehicle.

Party Wall. A wall common to two or more units which are intended to be individually owned.

Pedestrian. A person on foot or a self-propelled conveyance intended for use of persons with physical impairments.

Person. An individual, firm, corporation, partnership, or association, or any combination of these, or any other legal or commercial entity acting as a unit.

Pre-existing Towers and Pre-existing Antennas. Any tower or antenna for which a building permit or wireless telecommunications permit (WTP) was issued prior to the effective date of this Title, including permitted towers or antennas that have not yet been constructed so long as such approval is current and not expired.

Public Drainage System. The system of storm sewers, channels, culverts, creeks, flows within public streets, and associated detention and water quality structures owned and maintained by the City of Cheyenne, Laramie County, or the Wyoming Department of Transportation.

Public Land. Land owned, controlled and/or operated by a governmental unit.

Published Notice. A notice provided in accordance with Wyoming Statutes.

Redevelopment. The replacement of impervious surfaces on a developed site that is surrounded by urban development on at least three sides. Redevelopment occurs when the existing facilities are demolished and rebuilt or substantially changed through reconstruction. Resurfacing parking lots with no charge in overall dimensions or drainage patterns is not considered redevelopment even if the pavement is completely replaced.

Regional Detention Facilities. A system or parts of a system to control run-off from a defined area within a drainage basin and designed to coordinate with other similar facilities to manage the drainage basin and tributaries, typically considering areas greater than 100 acres or capacities of more than 30 acre-feet or as otherwise specified in a drainage master plan or current Storm Drainage Manual.

Remainder Lot. A lot or tract of land designated on a plat which is not eligible for development, or to service adjacent development, and may be reserved for future platting. A remainder lot shall not be for the purpose of sale, lease, or financing; nor be eligible for development. Remainder lots shall not be required to meet the dimensional standards of the zoning district. Developed properties, excluding land developed for agricultural purposes, are not eligible to be remainder lots. Remainder lot(s) must be referred to as "outlots", "remainder lots", or "tracts" on plats.

Right-of-way. Land dedicated and set aside for use by the public, primarily for the right of vehicle or pedestrian travel, but typically designed to include multiple and other public purposes.

Roadway. That portion of a street designed and intended primarily for vehicles.

Sanitary System. A sewer system or systems including mechanisms of collection, treatment and disposal of domestic and/or commercial sewage.

Screening. A feature used to visually separate elements on abutting or adjacent development sites.

Sidewalk. That portion of a street designed and intended primarily for use of pedestrians.

Sign. Any announcement, declaration, demonstration, display illustration or insignia, or other identification, that is visible from any public place or is located on private property and exposed to the public and that directs attention to a product, service, place, activity, person, institution, business or solicitation, including structures that exist to support or enhance the sign.

Sign, Animated. A sign that uses movement or change of lighting to depict action or create a special effect or scene.

Signs, Building Marker. A sign indicating the name of a building, a date and incidental information about its construction, cut into a masonry surface or made of bronze or other permanent material.

Sign, Abandoned. A sign which no longer identifies or advertises a bona fide business, service, owner, product, or activity, and/or for which no legal owner can be found.

Sign, Electronic Message Center. A sign where alphabetic, pictographic or symbolic informational content can be changed or altered on a fixed display surface composed of electrically illuminated or mechanically driven, changeable segments.

Sign, Government. A sign erected and maintained by the United States or state of Wyoming, or any political subdivision thereof, for traffic direction or for designation of or direction to any school, hospital, historical site or public service, property or facility.

Sign, Nameplate. A sign giving only the name, address and/or occupation of an occupant or group of occupants.

Sign, Portable. A sign not permanently attached to the ground or other permanent structure, or a sign designed to be transported, including, but not limited to, signs designed to be transported by means of wheels, signs converted to A- or T-frames, and balloons used as signs. "Portable sign" shall not include umbrellas used for advertising, signs carried by individuals, and signs attached to or painted on vehicles parked and visible from the public right-of-way when such vehicle is used in the normal day-to-day operations of a business.

Site Plan. A plan of the land showing the existing and proposed features for the property.

Static. Having no motion within a particular message or copy displayed on a digital billboard.

Storm Sewer. An underground pipe system that carries stormwater from streets and other surfaces and discharges directly to a pond, stream or river; used interchangeably with the term "storm drain."

Stormwater Management. Anything associated with the planning, construction, maintenance, or regulation of facilities which collect, store, convey or treat stormwater.

Storm Water Pollution Prevention Plan (SWPPP). A written plan required under state and federal stormwater discharge permits identifying measures that will be implemented to minimize the discharge of pollutants in stormwater. Requirements for SWPPPs are specified in state and federal discharge permits. Requirements vary depending on whether the discharge permit is associated with municipal, industrial, or construction activities.

Stormwater Retrofit. A stormwater management practice designed for an existing development site that previously had either no stormwater management practice in place or a practice inadequate to meet the stormwater management requirements of the site.

Stormwater Runoff. Also known as *Stormwater*, means flow on the surface of the ground, resulting from precipitation. Interchangeable terms include drainage and runoff.

Street. Any public way for the movement of vehicular and pedestrian traffic which is an existing federal, state, county or municipal roadway; or a right-of-way shown upon a plat, and approved pursuant to law, whether improved or unimproved, and may comprise pavement, shoulders, curbs, gutters, sidewalks, parking areas and other areas within the right-of-way.

Street, Arterial. Refers to the functional classification of a street in the entire transportation network, which has considerable continuity over long distances, and which is more specifically designed for speeds, volume and applicability according to the context, the standards in these regulations, and other specific transportation plans and policies.

Street, Collector. Refers to the functional classification of a street in the entire transportation network, which has moderate continuity over medium distances, and which is more specifically designed for speeds, volume and applicability according to the context, the standards in these regulations, and other specific transportation plans and policies.

Street, Local. Refers to the functional classification of a street in the entire transportation network, which has limited continuity except for short distances, and which is more specifically designed for speeds, volume and applicability according to the context, the standards in these regulations, and other specific transportation plans and policies.

Structure. That which is built or constructed, an edifice, or building of any kind, or any piece of work artificially built up or composed of parts joined together in some definite manner.

Tiedown. Any device designed to anchor a manufactured home or any other accessory building or structure to the ground.

Temporary Use. A use or activity that is intended to occupy the site on a non-continuous basis for more than 14 days.

Tower. Any structure that is designed and constructed primarily for the purpose of supporting one or more antennas for telephone, radio and similar communication purposes, including self-supporting lattice towers, guyed towers or monopole towers. The term includes, but is not limited to, radio and television transmission towers, microwave towers, common-carrier towers, cellular telephone towers, alternative tower structures and any tower support.

Tract. A unit of land established by a plat or otherwise as permitted by law, designated for limited or no development as part of an approved plan for a legitimate public or community purpose and designated for public or common ownership and maintenance.

Traffic-control Devices. Signs, signals, markings, or other approved geometric designs in the roadway approved by the public body or official having jurisdiction for the purpose of regulating, warning, guiding, or calming traffic.

Triple frontage lot. See "Lot, triple frontage."

Unit Space. A designated portion of a manufactured home park for the accommodation of one manufactured home.

Urban Drainage and Flood Control District (UDFCD). The metropolitan Denver drainage organization.

Utilities, Essential Services. Those utility facilities that provide end user services to customers. They include local distribution and collection lines for gas, electricity, water, sewer, telephone or cable TV services throughout neighborhoods and connect with each customer. They consist of cables, wires or pipes

with limited capacities and the associated hardware, such as transformers, relays and shut-off valves. They also consist of traffic-control boxes and traffic signal installations.

Utility Facilities. Any utility facility, whether or not regulated by the Wyoming Public Service Commission, not described as an essential service utility.

Wall, Retaining. A physical barrier necessary to prevent erosion and/or retain earth.

Water Quality Capture Volume (WQCV). Represents runoff from frequent storm events such as the 80th percentile storm. The volume varies depending on local rainfall data. The WQCV is based on runoff from 0.6 inches of precipitation (approximately 0.5 inches of runoff).

Water System. A public or private system of providing potable water to a structure for domestic use.

Woonerf. A street designed for use by pedestrian and vehicular traffic, where the pedestrian has the right-of-way.

WyDEQ. The Wyoming Department of Environmental Quality.

1.4.4 Descriptions of Uses of Land and Buildings

This section contains general descriptions associated with the uses of land and buildings. It is organized according to categories of uses and specific types of uses within each category. These categories and types correspond to the Use Table in Article 5, Zoning Regulations. Where a use appears to meet two or more descriptions or where a use is not described, the Director shall make a determination. If a use meets all of the characteristics of a use category and use type, or is so similar to a described use type as to create no anticipated differential impact, the Director may interpret that the described use includes the additional use. In making this determination, the Director shall compare: (a) the intensity and scale of the use relative to the site; (b) the typical site and building designs associated with the use; (c) the functional or operational characteristics and the potential impacts of the use on adjacent property; and (d) the potential contribution of the use to the overall character of the district or districts in which the comparable use is allowed. All other uses which cannot be interpreted in this manner are different from the described uses, are not anticipated by these regulations, and may only be allowed by a zoning text amendment.

- a. **Residential Uses.** The Residential use category is for all types of dwelling units used for permanent residence, including a variety of lot types, building types, and unit types, that may vary in the kind and classes of buildings based on the character of the neighborhood.

Attached Dwelling ("Townhouse" / "Rowhouse"). A Residential use in a building designed with a series of attached principal dwelling units separated by a single common wall. Each unit is typically situated on its own fee simple lot where party walls are used, but buildings or grounds may be owned in common. Each unit has the same orientation and front façade, and has its own private entrance to the exterior of the structure.

Detached Dwelling. A Residential use in a detached building designed as a single principal dwelling unit and situated on its own fee simple lot.

Semi-attached Dwelling ("Duplex"). A Residential use in a detached building designed as two principal dwelling units. It may be designed as a "paired house," matching the appearance of a house, or it may be designed as a "flat-over-flat," matching the appearance of a small apartment building. A duplex is situated on its own fee simple lot, but each unit of a side-by-side paired house may be platted on an individual lot if party walls are used.

Cottage Lot. A Residential use utilizing detached dwellings, semi-attached dwellings, or attached dwellings designed to face a common area (typically open space) with other shared facilities (such as shared public street access, shared parking, shared trash collection, etc.). Individual dwelling units may be on fee simple lots, a condominium, or on one larger ownership parcel. A cottage lot is also known as "bungalow court" or "cottage court". Cottage lots are subject to the provisions of UDC Section 6.6.5.

Group Housing. A residential use, Group Housing is the provision of in-home, 24-hour, 7-days a week custodial care for from 1 to 6 individuals living together as a single housekeeping unit in a single-family, detached dwelling unit. This maximum number excludes staff. This use does not include a household where custodial care is provided by a family member to from 1 to 6 persons in a single-family, detached dwelling unit. Custodial care includes the provision of in-home personal assistance, housekeeping service, supervision, and limited medical assistance

to a resident or residents. Examples of Group Housing include, but are not limited to, homes for elders and disabled or mobility- impaired persons, homes for rehabilitation from drugs or alcohol addiction, or homes for formerly incarcerated persons. The Group Housing use is subject to the provisions of Section 5.7.5.d and e of the UDC.

Dormitories. A Residential use in a building that provides sleeping accommodations for a number of people.

Multi-dwelling Building ("Apartment"). A Residential use in a building designed for more than two principal dwelling units and situated on a single fee simple lot. This building type includes a variety of variations based on the permitted building scale, including "stacked flats" (3-story/tri-plex), "six-plex" (paired stacked flats), or larger apartment buildings.

Live/Work. A primarily residential use in a building designed for two principal uses, where a portion is designed for residential dwelling use, and a portion is designed for a limited non-residential use to support the occupation or vocation of the resident of the dwelling unit. The non-residential portion is limited to the 1st story and less than 50% of the total floor area of the building. The building is situated on its own fee simple lot but may be attached or detached based on zoning district standards and context.

Mixed-use Dwelling. A Residential use in a building designed for a mix of uses with office or retail on the 1st story / street-front and residential uses on the upper stories where the dwelling units are not accessory to the non-residential uses. Mixed-use buildings may be either small- or large-scale, with larger scale buildings, depending on the context and zoning district standards, and typically being broken into multiple fee simple lots with party walls, but the dwelling units may be owned in fee simple, as condominiums, or apartments.

Accessory Dwelling. A separate dwelling unit that is associated with, incidental to, and subordinate to another dwelling unit as the principal use, and is located on the same lot as the principal dwelling (commonly referred to as "In-laws Quarters" or "Garage Apartment").

Urban Loft Building. A residential use in a building designed for more than two principal dwelling units and situated on a single fee simple lot. This building type contemplates a taller multifamily building, often with parking structured or at grade with the building above, located in a walkable, mixed use context.

Manufactured housing parks. An area of land under one fee ownership, where designated spaces for manufactured home are rented for use as a principal dwelling unit, and which may provide associated facilities for common use.

- b. **Civic Uses.** The Civic use category includes uses serving a broad and general public and community interest to enhance daily cultural, social or recreation opportunities for area landowners and residents. This category is based on the need of different kinds and classes of buildings in close proximity with other uses, which can be integrated in to these areas with the appropriate level of civic design. The Civic use category may contain uses that are either public and accessible to all citizens; common and accessible by rights associated with ownership; or private and accessible by membership or general association.

Neighborhood Assembly (<350 maximum occupancy). A Civic use that conducts organized services, assemblies, or programs on a periodic or occasional basis, primarily for the convenience, entertainment, education, and social or spiritual welfare of nearby residents. Neighborhood Assemblies typically have buildings and supporting facilities designed for a capacity of no more than 350 people for any one event. Common examples include meeting halls, neighborhood association club houses, or smaller neighborhood churches.

Community Assembly (350 -1000 maximum occupancy). A Civic use that conducts organized services, assemblies, or programs on a periodic or occasional basis, primarily for the convenience, entertainment, education, and social or spiritual welfare for citizens in the general vicinity. Community Assemblies typically have buildings and supporting facilities designed for a capacity of no more than 1000 people for any one event. Common examples include community centers, museum, or large churches. [For larger assemblies see Entertainment, Venue].

Cemeteries. A Civic use where land is used for the burial of the deceased, both human and animals,

and dedicated for internment purposes, including columbaria, crematoria, mausoleums and mortuaries when operated in conjunction with and within the boundary of such cemetery.

Primary and Secondary Schools. A Civic use where buildings and facilities are used for the education and instruction of K through 12 students.

Educational Facilities. A Civic use where buildings and facilities are used for the education and instruction of post-secondary students, non-traditional students, or continuing education for adult or general population.

Community Athletic Field. A noncommercial facility for active outdoor recreation and organized sports, including a facility which is an accessory use to a school, but excluding any facility with lighted fields or permanent buildings for refreshment stands, locker rooms or shower facilities.

Developed Athletic Field or Stadium. A facility for active outdoor recreation and organized sports which includes lighted fields, permanent grandstands, or permanent buildings for refreshment stands, locker rooms or shower facilities.

- c. **Service Uses.** The Service use category is for businesses engaged in the exchange of professional skills, advice, personal care or other resources, and the nature of the exchange generally requires frequent interactions with the clients, customers or patrons on the premises, and where lots or buildings may require access or exposure to the public-at-large.

Service Business – Limited. A Service use that primarily supports adjacent residential uses by providing daily services for the convenience of residents, and involving less than 3,000 square feet of gross leasable area. Examples include post office, bank outlet, barber shop or beauty salon, tailor, or other similar services.

Service Business – General. A Service use that provides support for adjacent residential uses or businesses which may involve more than 3,000 square feet of gross leasable area. Examples include copy centers, large banks, or any other similar services that exceed the scale of Service Business – Limited.

Assisted Living Facility / Nursing Home. A Service use / institutional occupancy providing residential

accommodations for 7 or more persons to meet the needs of the aging, semi-dependent or dependent population in a residential environment, together with recreation and support services and facilities for the benefit of the residents and where any permanent on-site staff is accessory to the primarily residential use. On-site skilled nursing care or medical facilities may be provided. An Assisted Living Facility/Nursing Home use is subject to the provisions of Section 5.7.5 of the UDC. An Assisted Living facility/Nursing Home use, pursuant to this definition, does not include a Group Housing use or site. An Assisted Living Facility/Nursing Home operation may take place within a residential or a non-residential structure.

Animal Care, Kennel. A Service use where domestic animals are boarded, bred or sold as a primary business.

Animal Care, Hospital / Clinic. A Service use where animals are admitted for examination, treatment, or health care by a doctor of veterinary medicine, which may include kennels, runs or other accessory accommodations.

Family Child Care Home (FCCH). A Service use where preschool care and education is provided for up to 10 children within the owner's primary residence. The owner's infants, toddler and/or children ages three (3) to five (5) shall count toward the capacity.

Family Child Care Center (FCCC). A Service use where preschool care and education is provided for up to 15 children within the owner's primary residence. The owner's infants, toddler and/or children ages three (3) to five (5) shall count toward the capacity.

Child Care Center (CCC). A Service use where preschool care and education is provided for children on a regular basis not located in any person's residence.

Emergency Shelter. A facility, which provides shelter or overnight accommodations and incidental support services for persons experiencing homelessness and/or families on a short-term basis.

Entertainment, Indoor Recreation Facility. A Service use where facilities for indoor sports, entertainment, or similar recreation opportunities for participants and spectators are offered. Examples of uses include bowling alleys, pool halls, roller skating rinks, swimming pools, movie theaters, video or similar gaming venues, racquetball courts, or fitness clubs.

Entertainment, Outdoor Recreation Facility. A Service use where facilities for outdoor sports, entertainment, or similar recreation opportunities for participants and spectators are offered. Examples include racetracks, driving ranges, music performance venues, or other outdoor entertainment venues.

Entertainment, Venue. A Service use where music concerts, floor shows or other forms of entertainment, performances or presentations by persons are provided indoors for guests or the general public, which may include accessory dining, bar, and similar refreshment services. Examples include concert halls, theatrical performance art centers, dinner theaters, other food or beverage-serving establishments providing live entertainment venues, banquet halls, or auditoriums.

Entertainment, Amusement, Recreation Services—Other. A Service use primarily engaged in the operation of indoor or outdoor entertainment, amusement and recreation services not elsewhere classified, such as off-track betting, indoor or outdoor shooting range, amusement parks, or similar sports or recreation venues.

Lodging, Bed and Breakfast. A Service use where up to six guest rooms are rented, generally for short-term occupancy for sleeping, together with limited facilities for the accommodations of guests in a home-like atmosphere.

Lodging, Hotel or Motel. A Service use where six or more guest rooms are rented, generally for short-term occupancy for sleeping, together with incidental meeting rooms, restaurants and recreation facilities for the primary benefit of the guests.

Medical Care, Clinic. A Service use where physicians, dentists, or other health care professionals are associated for the purpose of carrying on their professions. A health clinic may include a dental or medical laboratory, after hours emergency care, but it may not include in-patient care or operating rooms for major surgery.

Medical Care, Office. A Service use where physicians, dentists, or other health care professionals carrying on their professions. A medical office may include a dental or medical laboratory, but may not include in-patient care or operating rooms for major surgery and may not be open for after-hours emergency care.

Medical Care, Hospital. A Service use providing health services, primarily for inpatients, and medical or surgical care of the sick or injured, including as an integral part of the institution such related facilities as laboratories, outpatient departments, training facilities, central service facilities and staff offices.

Mini Storage. A Service use where a building or group of buildings in a controlled access and fenced compound that contains varying sizes(s) of individual, compartmentalized and controlled-access stalls or lockers for the storage of a customer's goods or wares. Mini Storage may include individual units accessed from inside of a building offered for rent or lease for the storage of personal property. It may also include parking areas for the storage of vehicles, trailers, recreational vehicles, boats, snow mobiles and other similar items as an accessory use. Outdoor storage, or the storage of junk, explosives, or flammable materials and other noxious or dangerous materials are specifically prohibited.

Storage, Yard. A Service use where exterior yards are leased for the outdoor storage of large-item personal property such as boats or recreational vehicles.

- d. **Employment Uses.** The Employment use category is for businesses engaged in administrative, clerical, and professional operations and support, where products or services are of the nature that generally, when compared to Retail Use Types, do not require daily on-premise interactions with the clients, customers or patrons, and where lots and buildings are not primarily designed to maximize exposure to the public-at-large.

Home Occupation. A business which is carried on entirely within a legal or legal non-conforming dwelling or allowed accessory building, and which is clearly incidental and secondary to the use of the premises as a dwelling.

Office - Limited. An Employment use which is not an accessory to another use, but limited individual units of gross leasable area are less than 3,500 square feet, and where each owner or tenant typically employs less than 20 employees on premises. Examples include small-scale professional service offices such as accountants, architects, insurance, law, real estate, or other similar businesses which can operate within the unit square footage and employee limits of this category.

Office - General. An Employment use where individual units of gross leasable area are between 3,500 and 20,000 square feet, and where each owner or tenant typically employs between 20 and 100 employees on premises. Examples include large professional service offices such as accountants, architects, insurance, law, real estate, or other similar businesses which exceed the Office - Limited category, or other moderate size business or corporate employment operations.

Major Office or Office Complex. An Employment use where individual units of gross leasable area may be more than 20,000 square feet in a single building or group of buildings, and each owner or tenant may typically employ more than 100 employees on premises. Examples include major professional service firms or large corporate offices.

- e. **Commercial Uses.** The Commercial use category is for businesses engaged in the exchange of merchandise for general consumers, and nature of the exchange generally requires frequent interactions with the clients, customers or patrons on the premises, where lots or buildings are primarily designed for exposure to the public-at-large.

Convenience Retail / Corner Store (<2k). A Commercial use primarily engaged in the small-scale sale of household merchandise and general consumer products and involving less than 2,000 square feet of gross leasable area. Convenience Retail / Corner Store uses are characterized by target market areas of less than 1/4 mile radius for most of its on-premise sales or are associated accessory to an employment or service business.

Neighborhood Retail (<5K). A Commercial use primarily engaged in the small-scale sale of household merchandise and general consumer products and involving less than 5,000 square feet of gross leasable area. Neighborhood retail uses are characterized by a target market area of less than 1/2 mile radius for most of its on premise sales.

General Retail (5K - 25K). A Commercial use primarily engaged in the sale of household merchandise, specialty merchandise, and consumer products and involving between 5,000 and 25,000 square feet of gross leasable area. General Retail uses are characterized by a target market area of less than 1 mile radius for most of its on-premise sales.

Large-scale Retail (25K - 100K). A Commercial use primarily engaged in the sale of household merchandise, specialty merchandise or general consumer products and involving between 25,000 and 100,000 square feet of gross leasable area. Large-scale Retail uses are characterized by a target market area that may be greater than 1 mile radius for the on-premise component of its sales.

Warehouse Retail (> 100K). A Commercial use primarily engaged in the sale of household merchandise, specialty products, general consumer products, or wholesale products and involving greater than 100,000 square feet of gross leasable area. Warehouse Retail uses are characterized by a target market area that may be more than 1 mile radius for most of its sales.

Grocery Store (<45K). A Commercial use engaged in the retail sale of a broad range of food products and limited household products for consumption off premises, although some limited areas may be dedicated to the on-premise sale and consumption of food. A grocery store involves less than 45,000 square feet of gross leasable area and is characterized by a target market of less than 1-mile radius.

Supermarket (> 45K). A Commercial use engaged in the retail sale of a broad range of food and household products for consumption off premises, although some limited areas may be dedicated to the on-premise sale and consumption of food. A supermarket typically involves more than 45,000 square feet of gross leasable area and is characterized by a target market of greater than 1-mile radius.

Outdoor Sales, Limited. The limited display of merchandise on a sidewalk or an exterior private area of a site associated with an otherwise permitted Commercial use. This display is further limited by the following: (1) it only occurs during regular business hours and is brought indoors; (2) is limited in extent to less than 10% of the entire merchandise area of the Commercial use; and (3) it is limited to seasonal sales or events lasting no longer than one-week at a time with at least 4 weeks between consecutive events.

Outdoor Sales, Seasonal. The limited display of merchandise on a sidewalk or an exterior private area of a site associated with an otherwise permitted

Commercial use. This display is further limited by the following: (1) it only occurs during regular business hours and is brought indoors; (2) is limited in extent to less than 20% of the entire merchandise area of the Commercial use; and (3) it is limited to seasonal sales or events lasting no longer than one month at a time with at least 2 months between consecutive events.

Outdoor Sales, Event or Display Area. The display of merchandise on a sidewalk or an exterior private area of a site associated with an otherwise permitted Commercial use that does not meet the limitations of Limited or Seasonal Outdoor Sales, and which may require areas to be designed and dedicated for display when part of the permanent operations of an interior retail business. Examples include lumber yards and garden centers.

Outdoor Sales. The display and sale of merchandise where the primary business is generated by merchandise displayed permanently and year round on an exterior portion of the site. Examples include automobile sales and implement sales.

Bars. A Commercial use primarily engaged in serving alcoholic beverages for consumption on-premises. Any food or entertainment services are generally secondary or accessory to the business.

Liquor Store. A Commercial use engaged primarily in the retail sale of alcoholic beverages for consumption off-premises. The sale of food or accessory beverage supplies are generally secondary or accessory to the business.

Automobile Repair. A Commercial use engaged in the repair, maintenance, or condition of motor vehicles and including the accessory sales of lubricants, parts, or accessories.

Automobile Service Station – Limited. A Commercial use engaged in the retail sale of fuel, and may include accessory sales of lubricants, accessories, repair services, or maintenance services. This use is limited to no more than 2 fuel pump islands and no more than 8 fueling stations.

Automobile Service Station – General. A Commercial use engaged in the retail sale of fuel, and may include accessory sales of lubricants, accessories,

repair services, or maintenance services, or accessory Convenience Retail. This use is limited to no more than 4 fuel pump islands and no more than 16 fueling stations.

Automobile Service Station – Large-scale. A Commercial use engaged in the retail sale of fuel, and may include accessory sales of lubricants, accessories, repair services, or maintenance services, or accessory Convenience Retail. This use may have more than 4 fuel pump islands and more than 16 fueling stations.

Food Service – Limited (< 2K). Any Commercial use engaged in the preparation and retail sale of food and beverages for consumption on-site and including less than 2,000 square feet of seating area.

Food Service – General (2K – 4K). Any Commercial use engaged in the preparation and retail sale of food and beverages for consumption on-site and including between 2,000 and 4,000 square feet of seating area.

Food Service – Large-scale (> 4k). Any Commercial use engaged in the preparation and retail sale of food and beverages for consumption on site and including more than 4,000 square feet of seating area.

- f. **Industrial Use Category.** The Industrial use category is for businesses engaged in manufacturing, fabrication, warehousing, processing, wholesale or disposal of goods, products and component parts, and services related to these businesses. These uses typically belong in a special district due to their inability to blend with the uses from other use categories, except when occurring at the smallest scale.

Data Center. A use consisting of buildings or structures specifically designed or modified to house networked computers and data and transaction processing equipment and related infrastructure support equipment, including power and cooling equipment. A data center may be used to provide data and transaction processing services, outsource information technology services and/or computer equipment colocation services. A data center may also include buildings or structures that support the operation of the data center including retrofit buildings, warehousing for logistics, independent network buildings, buildings for support staff, and

emergency generators. A Data Center shall not include activities which consistently produce noise discernable at the property line. Should a Data Center produce noise discernable at the property line, it shall be classified as an Industrial use.

Limited Industrial. An Industrial use where small-scale activities produce no byproducts such as smoke, odor, dust or noise discernable from the outside of the building in which it is located. Individual facilities typically occupy less than 10,000 square feet of gross leasable area and distribution and deliveries are commonly made by general consumer delivery services, requiring no significant truck access. A retail, showroom, or service component is often associated with the use. Examples include artist studios, metal and wood shops, arts and crafts manufacturing, small appliance or machine repairs, or other small-scale assembly of finished parts or products from previously prepared materials.

Moderate Industrial. An Industrial use where byproducts such as smoke, odor, dust or noise are not discernable from outside of the building in which it is located. Distribution and deliveries can occur from general consumer delivery services or limited commercial truck access. Examples include research labs or facilities, small electronics or computer assembly and manufacturing, furniture assembly.

General Industrial. An Industrial use where byproducts such as smoke, odor, dust or noise are not discernable from beyond the property boundary. Operations may require commercial vehicle access for distribution and deliveries. Examples include non-animal food processing, commercial warehouses or wholesale distribution centers or energy industry services.

Industrial. An Industrial use capable of producing significant byproducts discernable from outside the building and property including noise, odors, or other potentially offensive materials. Operations may require substantial commercial vehicle access for distribution and deliveries. Examples include food-processing involving animals (large-scale), metal or chemical manufacturing, and data centers which consistently produce noise discernable at the property line.

Limited Outdoor Storage. A use where less than 50% of the lot is used to store equipment and other materials customarily used in the operations associated with the principal use of the property in an unenclosed area.

Outdoor Storage. A use not classified as Limited Outdoor Storage where property is used to store equipment, vehicles, or other materials in an unenclosed area.

Impoundment Yards. An industrial use where a government agency establishes and operates a fenced yard or enclosed area where storage of vehicles seized by, and in the custody of, the government agency, are stored for retrieval by the vehicle owner or are sold by proper means by the agency.

Salvage Yards. An Industrial use where materials are extracted from unusable equipment, structures, or vehicles and stored for future use or resale.

Junk Yards. An Industrial use where waste or used material are bought, sold, exchanged, stored or processed for disposal.

Pet Crematory. An Industrial use where land and buildings are used for the preparation and processing of deceased domestic animals.

Air Cargo Terminals. An Industrial use where land and buildings are used for the storage of airplanes, airplane cargo or other facilities associated with air transportation or air shipping.

Aircraft Sales, Repair, Service, Storage. An Industrial use where land and buildings are used for keeping inventory related to aircraft sales or for the storage and maintenance of aircraft.

Railroad Yards and Maintenance Buildings. An Industrial use where land and buildings are used for the storage of rail cars, rail cargo or other facilities associated with rail transportation or rail shipping.

g. **Public Service Uses.** The Public Service use category is for businesses or government entities engaged providing technical and operational services that serve the general public and community interest to enhance general health, safety, welfare and convenience for landowners and residents, and that serve interests beyond the specific site

or facility. This category is based on the need of different kinds and classes of buildings in close proximity with other uses, which can be buffered from the adjacent areas they serve with the appropriate site design, or alternatively which can be located in special purpose districts and still serve the public interest.

Commercial or Public Parking Facility. A Public Service use where land and buildings are used for hourly or daily parking of passenger vehicles that serves other uses, sites and buildings in the vicinity. The parking services may be owned by the government or owned and operated as a business.

Government Facility. A facility or area of land controlled and/or operated by a government entity to aid in providing a service to the citizens under the jurisdiction of that entity.

Military. A Public Service use where land and buildings are used for operations of the United States Armed Forces.

Recycling Services. A Public Service use where land and buildings are used for the public drop-off, storage, and packaging of recyclable materials. Processing may occur on site, or materials may be shipped to other industrial sites for further processing.

Transportation Facilities. A Public Service use engaged in the business of offering transportation services to the public, such as airport terminals, bus stations, train stations, taxi stations, parking garages, bicycle depots or similar facilities for common storage personal vehicles or common boarding of public vehicles.

Utility Stations. A Public Service use where land is used for the concentrated location of fixed equipment necessary to serve adjacent areas with utility service, including other accessory buildings and facilities essential to the operation of the equipment.

h. **Agriculture Uses.** The Agriculture use category is for uses that are commonly associated with an agrarian or rustic lifestyle, and which demand little or no public infrastructure or services.

General Agriculture. The production of grain, animals, food and fiber; the science and art of farming and

ranching; and the work of cultivating the soil, producing crops and raising livestock. General Agriculture specifically excludes concentrated feeding operations where swine are confined, fed and maintained for 45 consecutive days or more in any 12-month period.

Limited Agriculture. The production of grain, animals, food and fiber on a small scale where any impacts on potential adjacent property from storage, operations, and equipment can be internalized into the site or buffered from abutting areas, typically not occurring on lots or parcels larger than 10 acres.

Agricultural Equipment and Supply. An Agriculture use where the land and buildings are used for retail sales of equipment and materials used for agricultural-related land uses, and accessory servicing of agriculture equipment.

Agriculture Product Sales / Farmers Market. An Agriculture use where land and buildings are used for the retail sale of agricultural products and operated without any additional or permanent site facilities than are otherwise associated with agriculture use. Road side stands, truck sales, or barn sales are examples of such uses, however the intensity and frequency of such sales shall be so that no additional parking, roads, structures, warehouses, or other storage facilities are necessary on the site.

Arenas and Show Barns. An Agriculture use where the land and buildings are used for show or sale of livestock, and where the public can attend these and other related activities.

Commercial Stables. An Agriculture use where land and buildings are used for the business of boarding horses, donkeys, mules, burros, llamas or other similar equine animals.

Nurseries, Landscaping. An Agriculture use to grow plants of any kind for transplanting to another location or for sale as live plants rather than as crops, including the sale of related equipment and supplies.

1.4.5 Interpretation of Zoning Map

Where uncertainty exists with respect to any of the boundaries of a zoning district as shown on the zoning map, the following rules shall apply:

- a. Where district boundaries are indicated as approximately following the centerlines of streets or highways or railroad right-of-way lines or the lines extended, they shall be construed to be the boundaries.
- b. Where district boundaries are indicated as approximately following the corporate limit line of the City, the corporate limit line shall be construed to be the boundaries.
- c. Where district boundaries are indicated as approximately following property lines or the lines extended, the property lines or the lines extended shall be construed to be the boundaries.
- d. Where district boundaries are indicated as approximately following the centerline of stream beds or riverbeds, the centerlines shall be construed to be the boundaries.
- e. Where district boundaries are indicated on unplatted properties, the line shall be interpreted as the ten (10) acre tract line created by the federal government under the Public Lands Survey, unless otherwise noted.
- f. Each zoning map page indicates from quarter section to four sections, with most pages showing only one section. When the zoning district designation is not shown on the section line or the edge boundary on any individual map, it shall be construed to be the edge boundary.

1.4.6 Interpretation of Comprehensive Plan and Future Land Use Maps

Where these regulations refer to the Comprehensive Plan, land use categories, or future land use maps, this shall include maps associated with the officially adopted Comprehensive Plan for the City. The maps shall be interpreted as follows:

- a. The maps are a general framework and guide for decision-making, and do not pre-determine any specific use of land or buildings, or application of any zoning category.
- b. The maps shall be interpreted and future zoning shall be consistent with the concepts, policies, principles and strategies in the plan, including descriptions of categories

and activity centers, location criteria, checklists and other elements supporting the plan.

- c. Specific area plans, whether adopted by the City or proposed by private parties in accordance with these regulations, may be interpreted as an amendment or further refinement of the future land use map provided that plan is determined by the Planning Commission to be consistent with the Comprehensive Plan.

1.4.7 Resources, Guides and Industry Standards

- a. Resources, guides and industry standards that are recognized as reputable authority in the planning and urban design profession or engineering profession, may be used as a supplement to interpreting this code. Any use of such resources, guides and industry standards shall be subject to the approval of the Director upon a determination that the content is consistent with the Comprehensive Plan and the purposes, intent, and design objectives of these regulations. Any resource, guide, or industry standard approved by the Director shall be listed in Appendix A and at least one copy shall be kept on file with the Planning and Development Department.
- b. Design guidelines addressing any specific site or building design issues for public or private property may be prepared by the Planning and Development Department, and may be used as a supplement to interpreting this code. Any use of design guidelines shall be subject to the approval of the Director upon a determination that the content is consistent with the Comprehensive Plan and the purposes, intent, and design objectives of these regulations. The Director shall require approval by the Planning Commission, City Council, or other public review body prior to its use. Any design guidelines so approved shall be listed in Appendix B and at least one copy shall be kept on file with the Planning and Development Department.
- c. These materials may only be used to aid in the interpretation and application of these regulations, and any discretion specifically granted under these regulations, and shall not be used to otherwise modify, contradict, or in any way change the standards and requirements of these regulations.

ARTICLE 2 APPLICATIONS, PROCEDURES AND CRITERIA

2

Article 2, Applications, Procedures and Criteria provides the steps for applying the Unified Development Code standards to specific development applications. It includes the technical steps in the development review process and criteria for evaluating development applications. It is useful to anyone who may become involved in development review, including City staff, public officials, potential applicants and citizens.

UNIFIED DEVELOPMENT CODE

ARTICLE 2 APPLICATIONS, PROCEDURES AND CRITERIA

- 2.1 Divisions of Land
- 2.2 Zoning Applications
- 2.3 Appeals and Relief
- 2.4 Text Amendments and Annexations

2.1 DIVISIONS OF LAND

- 2.1.1 Administrative Plats
- 2.1.2 Preliminary Plat
- 2.1.3 Final Plat
- 2.1.4 Street Vacation
- 2.1.5 Limited Lot Line Adjustment Plat Waiver

2.1.1 Administrative Plats

a. **Intent.** Administrative plat procedures are intended to provide expedited review and approval for minor adjustments to legal boundaries, easements and title of property for proper recording. These adjustments have little or no impacts on public facilities and infrastructure and are within ownership patterns or development patterns that have otherwise been determined in accordance with the City's long-range comprehensive development plan.

b. **Applicability.** The administrative plat process is applicable for divisions of land in the City that meet the specific eligibility requirements in this section. The application for an administrative plat is initiated by the property owner(s) of all property subject to the application, or the property owner(s)'s authorized agent.

1. **General Eligibility.** All administrative plats shall meet the following threshold eligibility requirements:
 - (a) The application involves no adjustments to the layout of existing public streets or public areas, but may involve the addition of right-of-way to existing streets;
 - (b) The application involves no dedication of new public streets or public areas;

(c) The application involves no new area anticipated for potential dedication as public streets or public areas, whether through official plans or by operation of development regulation.

2. **Revised Final Plat.** Revisions to a previously approved final plat may be eligible for administrative approval where:

(a) The revisions are due to field conditions that could not have been reasonably anticipated or discovered at the time of the final plat which results in no material change to the application; or

(b) The revisions are due to changes in the development program, and these changes will result in no additional lots and will impact public facilities the same or similarly to the previously approved application; or

(c) The revisions are being done according to an approved Regulating Plan applying standards of Article 7, and are within the maximum approved development identified on the particular block or parcel in the Regulating Plan.

3. **Lot Line Adjustment.** Adjustments to previously platted lots may be eligible for administrative approval where:

(a) The adjustment affects no more than 4 lots;

(b) The adjustment results in no additional lots; and

(c) The adjustment creates no non-conformances on any lot.

4. **Simple Subdivision.** A simple subdivision of lots may be eligible for administrative approval where:

(a) It results in no more than 3 new lots; and

(b) No portion of the new lots have been created previously through a simple subdivision approval.

5. **Easement Adjustments.** Adjustments, vacations or additions of easements may be eligible for administrative approval where :

(a) The revisions are due to field conditions that could not have been reasonably anticipated or discovered at the time of the final plat which result in no material change to the application;

(b) The revisions are due to changes in the

development program, and these changes will impact public facilities the same or similarly to the previously approved application; or

- (c) The application contains sufficient documentation showing the easement holder concurs with a proposed adjustment or vacation.
- c. **Specific Procedures.** An administrative plat has the following specific procedures:
1. **Pre-application Conference.** Prior to submittal of an application the applicant shall schedule at least 1 pre-application meeting with the staff to discuss the eligibility of the application for administrative review and the ability of potential future development on the property to meet the criteria.
 2. **Staff Review.** Upon submittal of a formal application, staff will conduct an internal review and may forward copies of the application to any pertinent external agencies for review and comment.
 - (a) **Complete Applications.** Within 7 days of submittal of the application, staff shall determine whether the application is complete according to official application requirements. Staff shall notify the applicant in writing of any deficiencies in incomplete applications giving directions and deadlines to cure the deficiencies. Staff shall schedule complete applications for formal internal review subject to the criteria in this section.
 - (b) **Posted Notice.** Not required.
 - (c) **Final Decision.** Upon review according to the criteria in this section, and between 7 and 15 days of the determination of a complete application, the Director shall take one of the following actions:
 - (1) Approve the application;
 - (2) Deny the application and state the specific reasons for denial;
 - (3) Refer the application to Planning Commission if at any point in the review the Director determines that the application is not eligible for an administrative plat process or otherwise does not meet the criteria for approval.
 3. **Effect of Decision.** The decision of the Director is the final decision and shall be made in writing. Approval of the application shall be valid for 1 year. If not acted on and recorded within 1 year the approval shall be void.
 4. **Recording.** Following approval of an administrative plat, the Director and the City Engineer shall sign the plat. The applicant shall then record the plat and other required documents in the office of the County Clerk and be responsible for any associated fees. The applicant shall provide a copy of the recorded plat to the Director prior to issuance of any building permits.
- d. **Review Criteria.** Prior to approving an administrative plat the Director shall find that the application meets all of the following criteria:
1. The division of land shall be consistent with the Comprehensive Plan.
 2. The division of land shall be consistent with development and ownership patterns in the vicinity, or consistent with any change in development and ownership patterns identified in the Comprehensive Plan or any specific area plans.
 3. The division of land meets the purposes, intent, and all applicable standards in Article 4.
 4. All potential development resulting from the application will produce no material and negative impacts on existing and planned public facilities in the area.
 5. Lots proposed for development shall be buildable lots according to the existing zoning district standards, result in design and development patterns that meet the Intent and Applicability statements of the existing zoning district, and not aggravate nonconforming setbacks or currently adopted building and fire code access and separation requirements.
 6. The division of land and/or Easement Adjustment will not create any undue influence on existing or potential development for adjacent property considering the existing zoning and Comprehensive Plan policies for that property.
 7. Remainder lot(s) shall be clearly identified on the administrative plat and shall not be developed or proposed for development purposes. Remainder lot(s) shall be noted and described on all plats either graphically or by legal description.
 8. All easement holders benefitting from an easement shall concur with the requested Easement Adjustment.

2.1.2 Preliminary Plat

a. **Intent.** Preliminary plat procedures are intended to determine whether the proposed division of land will comply with the long-range Comprehensive Plan for the City, will meet the design standards of the subdivision regulations, and will result in buildable lots capable of meeting the existing or proposed zoning standards, and meets other policies and standards contained in other applicable laws or regulations that may relate to development of specific property.

b. **Applicability.** The preliminary plat process is applicable to any division of land in the City or within 1 mile of the City that is not eligible for the administrative plat procedures. The application for a preliminary plat may be initiated by the property owner(s) of all property subject to the application, or the property owner(s)'s authorized agent.

c. **Specific Procedures.** A preliminary plat has the following specific procedures:

1. **Pre-application Conference.** A pre-application conference is not required, but is recommended for preliminary plat applications, particularly for development that is complex or phased. The pre-application conference may discuss general development concepts, long-range planning issues and policies for the property or vicinity, and specific application procedures and requirements for a formal application.

2. **Staff Review.** Upon submittal of a formal application staff will conduct an internal review and may forward copies of the application to any pertinent external agencies for review and comment.

(a) **Complete Applications.** Within 7 days of submittal of the application, staff shall determine whether the application is complete according to official application requirements. Staff shall notify the applicant in writing of any deficiencies in incomplete applications giving directions and deadlines to cure deficiencies. Staff shall schedule complete applications for review before the Planning Commission. The review shall be scheduled for the next available Planning Commission meeting between 15 to 60 days of the determination of a complete application.

(b) **Notice.** Prior to review by the Planning Commission

the following notice shall occur:

(1) **Posted Notice.** Staff shall provide 1 sign for each road frontage indicating that there is a pending development application. The applicant shall ensure that 1 sign for each road frontage is posted on the property for at least 7 days prior to the scheduled Planning Commission review. When the applicant has made all reasonable and good faith efforts to maintain posted notice, failure of this posted notice will not be grounds to invalidate the application.

(2) **Published Notice.** Notice shall be published in a newspaper of general circulation and to the City of Cheyenne website at least 15 days but no more than 21 days prior to the scheduled Planning Commission review indicating the general location of the property, the nature of the application, the location for further information on that application, and the date, time and location of the Planning Commission review.

(c) **Review Comments.** At least 7 days prior to the scheduled review before the Planning Commission, staff shall forward formal comments on the application to the Planning Commission, including any external agency comments. A copy of the comments shall be submitted to the applicant at this time.

3. **Expedited Review.** As part of the staff review, and in conjunction with the applicant, staff may make a determination that a proposed plat is eligible for expedited review. To be eligible for expedited review the preliminary plat shall contain no significant planning, design, and engineering issues. Upon a determination by staff, the applicant may submit a preliminary and final plat to the Planning Commission. Upon approval of the preliminary plat by Planning Commission, the final plat could advance to the City Council, including all engineering requirements for final plat applications, for review, approval and acceptance. Denial of an expedited preliminary plat by the Planning Commission shall terminate the application, except that the preliminary plat may be appealed to the City Council, as provided in this section. Each application would be otherwise processed according to the procedures and criteria in this section.

4. *Planning Commission Review.* The Planning Commission shall review the application subject to the criteria in this section, and take one of the following actions:
 - (a) Recommend approval of the preliminary plat and recommend that a final plat be prepared;
 - (b) Recommend approval of the preliminary plat with conditions and recommend that a final plat be prepared provided it addresses the conditions. Conditions or modifications shall be:
 - (1) to better meet standards and review criteria; or
 - (2) to address situations created by or aggravated by the proposed application, and which conditions are roughly proportional to the impacts of the proposed development;
 - (c) Recommend denial of the preliminary plat and state the specific reasons for denial;
 - (d) Postpone the application to collect additional information pertinent to the application or to take the matter under advisement.
5. *City Council Appeal.* Upon a recommendation from the Planning Commission, the application shall be scheduled for acknowledgement by the City Council at the next regular meeting. At this meeting City Council shall:
 - (a) Acknowledge the Planning Commission recommendation; or
 - (b) Amend or deny the Planning Commission recommendation based on a review of the merits of the application. This review shall consider:
 - (1) staff review comments and any outside agency comments;
 - (2) the Planning Commission's recommendations and the record before the Planning Commission; and
 - (3) the review criteria in this section.
6. *Effect of Decision.*
 - (a) *Approval.* Approval of the preliminary plat shall not constitute approval of the subdivision or development, and shall only be considered as authorization to prepare and present a Final Plat subject to the procedures, standards and criteria of these regulations. Approval shall be valid for up to 18 months, unless a phasing plan is specifically proposed in the preliminary plat. If a final plat is not submitted for any portion of the application within 18 months the approval shall be void. Approval of a final plat for a portion of the preliminary plat shall reauthorize for an additional 18 month period the entire preliminary plat unless otherwise specified as part of the final plat approval.
 - (b) *Denial.* Denial of a preliminary plat shall be a final decision and any further action shall require a new preliminary plat subject to the procedures, standards and criteria of these regulations. An applicant may appeal a denial of a preliminary plat by the Planning Commission to the City Council within 15 days of the decision. The appeal shall be scheduled for review and acknowledgement by the City Council according to the Council rules and procedures. The City Council shall review the application according to the criteria in this section.
- d. *Review Criteria.* In reviewing, providing comments, and making recommendations and decisions on a proposed preliminary plat, the Staff, Planning Commission and City Council shall use the following criteria:
 1. The application is in accordance with the development policies and physical patterns identified in the Comprehensive Plan.
 2. The application reflects sound planning and urban design principles with respect to existing and potential future development in the vicinity, including consideration of current and future streets, open spaces, blocks and lots, and public utilities or facilities.
 3. The division of land meets the purposes, intent, and all applicable standards in Article 4.
 4. Any phasing proposed in the application is clearly indicated and demonstrates a logical and well-planned development pattern. This may include consideration of amenities and public facilities of the subdivision within each phase compared to the anticipated timing or the likelihood of future phases being constructed as planned.
 5. The impacts identified in specific studies or technical reports that were prepared or requested to be prepared in association with the application, and whether the findings and recommendations of these reports, or any modifications or conditions on approval of the application, can mitigate these impacts.
 6. Lots proposed for development shall be buildable lots according to the existing or proposed zoning district standards, result in site design and development

patterns that meet the Intent and Applicability statements of the existing or proposed zoning district, and not aggravate nonconforming setbacks or currently adopted building and fire code access and separation requirements.

7. All parcels not proposed as buildable lots and which are not dedicated to and accepted by the City shall have a clearly defined entity responsible for ongoing maintenance.
8. The application will not create any undue influence on existing or potential development for adjacent property considering the existing zoning and Comprehensive Plan policies for that property.
9. The application is not harmful to the public health, safety, and welfare.
10. Remainder lot(s) shall be clearly identified on the preliminary plat and shall not be developed or proposed for development for purposes. Remainder lot(s) shall be noted and described on all plats either graphically or by legal description.

2.1.3 Final Plat

- a. **Intent.** Final plat procedures are intended to create an accurate public record for the sale of lots, to guarantee construction of all public improvements according to the standards in the subdivision regulations, and to ensure that all lots are buildable lots according to the appropriate zoning prior to recording.
- b. **Applicability.** The final plat process is applicable to any division of land in the City or within 1 mile of the City that has been acknowledged and approved by the City Council through the preliminary plat procedures. The application for a final plat may be initiated by the property owner(s) of all property subject to the application, or the property owner(s)'s authorized agent.
- c. **Specific Procedures.** A final plat has the following specific procedures:
 1. **Pre-application Conference.** A pre-application conference is not required for a final plat. It is only recommended if the final plat involves changes from an approved preliminary plat or involves issues meeting modification or conditions of the preliminary plat approval.
 2. **Staff Review.** Upon submittal of a formal application,

staff will conduct an internal review and may forward copies of the application to any pertinent external agencies for review and comment.

- (a) **Complete Applications.** Within 7 days of submittal of the application, staff shall determine whether the application is complete according to official submittal requirements. Staff shall notify the applicant in writing of any deficiencies in incomplete applications giving directions and deadlines to cure deficiencies. Staff shall schedule complete applications for review before the Planning Commission. The review shall be scheduled for the next available Planning Commission meeting between 15 to 60 days of the determination of a complete application. Any application for a final plat that is consistent with a preliminary plat that was reviewed and acknowledged by the Planning Commission and City Council without modifications or conditions may bypass the Planning Commission review and be submitted directly to City Council with a staff recommendation.
- (b) **Notice.** Prior to review by the Planning Commission the following notice shall occur:
 - (1) **Posted Notice.** Staff shall provide 1 sign for each road frontage indicating that there is a pending development application. The applicant shall ensure that 1 sign for each road frontage is posted on the property for at least 7 days prior to the scheduled Planning Commission review. When the applicant has made all reasonable and good faith efforts to maintain posted notice, failure of this posted notice will not be grounds to invalidate the application.
 - (2) **Published Notice.** Notice shall be published in a newspaper of general circulation and to the City of Cheyenne website at least 15 days but no more than 21 days prior to the scheduled Planning Commission review indicating the general location of the property, the nature of the application, the location for further information on that application, and the date, time and location of the Planning Commission review.
- (c) **Comments.** At least 7 days prior to the scheduled review before the Planning Commission, staff shall forward formal comments on the application to the Planning Commission, including any external

agency comments. A copy of the comments shall be submitted to the applicant at this time.

3. *Planning Commission Review.* The Planning Commission shall review the application subject to the criteria in this section, and take one of the following actions:

- (a) Recommend to the City Council that the application be approved;
- (b) Recommend to the City Council that the application be approved with specific conditions or modifications. Conditions or modifications shall be:
 - (1) to better meet standards and review criteria; or
 - (2) to address situations created by or aggravated by the proposed application, and which conditions are roughly proportional to the impacts of the proposed development;
- (c) Recommend to the City Council that the application be denied, and state the specific reasons for denial;
- (d) Postpone the application to collect additional information pertinent to the application or to take the matter under advisement.

4. *City Council Approval and Acceptance.* Upon recommendation of the Planning Commission or Staff, the application shall be scheduled for approval and acceptance by the City Council at the next regular meeting. At this meeting City Council shall review the application subject to the criteria of this sections and:

- (a) Approve the final plat;
- (b) Approve the final plat with specific conditions or modifications. Conditions or modifications shall be:
 - (1) to better meet standards and review criteria; or
 - (2) to address situations created by or aggravated by the proposed application, and which conditions are roughly proportional to the impacts of the proposed development;
- (c) Deny the final plat, and state the specific reasons for denial; or
- (d) Postpone the application to collect additional information pertinent to the application or to take the matter under advisement.

5. *Effect of Decision.* The decision of the City Council is the final decision.

- (a) *Approval and Acceptance.* Approval and acceptance shall be valid for up to 18 months. If the final plat is not acted on and recorded within 18 months the approval shall be void and have the effect of a denial.
- (b) *Denial.* Denial of a final plat shall prohibit any development activity in association with the application. Any new activity shall require a new preliminary plat according to the standards and procedures of these regulations.

6. *Recording.* Following approval of a final plat, the Director, the City Clerk, and the Mayor shall sign the plat. The applicant shall then record the plat and other required documents in the office of the County Clerk and be responsible for any associated fees. The applicant shall provide a copy of the recorded plat to the Director prior to issuance of any building permits.

d. *Review Criteria.* In reviewing, providing comments, and making recommendations and decisions on a proposed final plat, Staff, Planning Commission and City Council shall use the following criteria:

- 1. The layout and design of the final plat is in substantial compliance with the approved preliminary plat considering the number of lots or parcels, street and block layout, and access, and any deviations in the final plat brings the application in further compliance with the Comprehensive Plan.
- 2. The application meets any conditions or modifications of the approved preliminary plat.
- 3. The application meets the purposes, intent, and applicable standards of Article 4.

2.1.4 Street Vacation

a. *Intent.* Street vacation procedures are intended to provide review of changes to streets and any associated parcel boundaries previously platted or otherwise dedicated to the City.

b. *Applicability.* An application for a street vacation may be initiated by:

- 1. The City Council on its own initiative;
- 2. The Planning Commission or staff through a petition to the City Council, signed by the Chair of the Planning Commission or Director respectively; or

ARTICLE 2

APPLICATIONS, PROCEDURES AND CRITERIA

2.1 DIVISIONS OF LAND

3. The property owner(s), signed by the owner(s) or authorized agent of all property affected by the vacation.
- c. **Specific Procedures.** A street vacation has the following specific procedures:
1. **Pre-application Conference.** A pre-application conference is not required, but is recommended for street vacation applications. The pre-application conference may discuss general development concepts, long-range planning issues and policies for the property or vicinity, and specific application procedures and requirements for a formal application.
 2. **Staff Review.** Upon receipt of a formal application staff will conduct an internal review and may forward copies of the application to any pertinent external agencies for review and comment.
 - (a) **Complete Application.** Within 7 days of submittal of the application, staff shall determine whether the application is complete according to official application requirements. Staff shall notify the applicant in writing of any deficiencies in incomplete applications giving directions and deadlines to cure deficiencies. Staff shall schedule complete applications for a public hearing before the Planning Commission. The public hearing shall be scheduled for the next available Planning Commission meeting between 15 to 60 days of the determination of a complete application.
 - (b) **Notice.** Prior to the Planning Commission public hearing the following notice shall occur:
 - (1) **Posted Notice.** Staff shall provide 1 sign for each road frontage indicating that there is a pending development application. The applicant shall ensure that 1 sign for each road frontage is posted on the property for at least 7 days prior to the scheduled Planning Commission review. When the applicant has made all reasonable and good faith efforts to maintain posted notice, failure of this posted notice will not be grounds to invalidate the application.
 - (2) **Published Notice.** Notice shall be published in a newspaper of general circulation and to the City of Cheyenne website at least 15 days but no more than 21 days prior to the scheduled Planning Commission review indicating the general location of the property, the nature of the application, the location for further information on that application, and the date, time and location of the Planning Commission review.
 - (3) **Mailed Notice.** All owners within 300' of subject property shall be mailed notice indicating the general location of the property, the nature of the application, the location for further information on that application, and the date, time and location of the Planning Commission public hearing. When mailed notice is properly addressed based on the latest property information and deposited in the mail at least 15 days prior to the scheduled hearing, failure of a party to receive such notice will not be grounds to invalidate any action taken.
 - (c) **Comments.** At least 7 days prior to the Planning Commission public hearing, staff shall forward formal comments on the application to the Planning Commission, including any external agency comments. A copy of the comments shall be submitted to the applicant at this time.
3. **Planning Commission Public Hearing.** Planning Commission shall review the application according to the criteria in this section. At the close of the public hearing the Planning Commission shall:
 - (a) Recommend to the City Council that the application be approved;
 - (b) Recommend to the City Council that the application be approved with specific conditions or modifications;
 - (c) Recommend to the City Council that the application be denied, and state the specific reasons for denial;
 - (d) Postpone the application to collect additional information pertinent to the application or to take the matter under advisement.
 4. **City Council Review.** Upon a recommendation from the Planning Commission, the application shall be scheduled for review by the City Council according to the following:
 - (a) **First Reading.** At the first regular meeting after the Planning Commission recommendation, the City Council shall conduct the first reading on the

application. After the first reading, the Council may schedule a public hearing on the application at either a regular meeting or a special meeting, at the Council's discretion. Notice shall be provided according the same requirements for the Planning Commission public hearing.

(b) *Second Reading.* At least 15 days but no more than 35 days after the Planning Commission recommendation or close of any Council public hearing, the Council shall conduct the second reading on the application. After the first reading, the Council may schedule a public hearing on the application at either a regular meeting or a special meeting, at the Council's discretion. Notice shall be provided according the same requirements for the Planning Commission public hearing.

(c) *Final Reading.* At the first regular meeting after the second reading or close of any Council public hearing, the City Council shall conduct the final reading on the application. The Council shall:

- (1) Approve the application;
- (2) Approve the application with specific conditions or modifications;
- (3) Deny the application, and state the specific reasons for denial; or
- (4) Postpone the application to collect additional information pertinent to the application or to take the matter under advisement. When postponed, new notice shall be required. The continued hearing shall occur at the next City Council regular meeting, or at some other time within 60 days with the consent of the applicant. No application may be postponed more than once by the City Council without the applicant's consent.

5. *Effect of Decision.* The decision by the City Council is the final decision. Upon approval of a street vacation, the change shall be effective on the date of approval, or any other specific date in the ordinance approving the amendment.

d. *Review Criteria.* In reviewing, providing comments, and making recommendations and decisions on a proposed street vacation, the staff, Planning Commission and City Council shall use the following criteria:

1. The vacation meets the purposes, intent, and

applicable standards of Article 4.

2. The ability of all existing and potential future development on adjacent lots to meet all applicable standards for development in the existing zoning district, including other development options in the event that any specific development proposed in association with the vacation is not executed after approval.
3. The vacation reflects sound planning and urban design principles with respect to existing and potential future development in the vicinity, including consideration of current and future streets, open spaces, blocks and lots, and public utilities or facilities.
4. The application meets the public interest, and is not otherwise prohibited by other city, state or federal laws.
5. The review and recommendations of other reviewing bodies.

2.1.5 Limited Lot Line Adjustment Plat Waiver

a. *Applicability.* The limited lot line adjustment waiver process is applicable for projects affecting no more than two (2) lots and the application meets the following qualifying criteria:

- (a) The adjustment qualifies as a 2.1.1.b.3 Lot Line adjustment; and
- (b) The adjustment does not impact a public right-of-way; and
- (c) This provision is used only once for any lot.

b. After a mandatory pre-application meeting, the Applicant for a qualifying limited lot line adjustment plat waiver shall submit the following material for review by the Development Director or his/her designee. It is the prerogative of the Director to send the application to relevant City Agencies for review. The proposed application shall include:

- (i) A dimensioned plot plan, to scale, of the land showing existing structures, if any (an "as built" plot plan); and
- (ii) A dimensioned plot plan showing the proposed lot lines with the current lot lines shown in shadow lines ("ghosted") and showing all existing and proposed easements, if any; and
- (iii) Contact information for the current owner(s) and the Applicant and the Agent for the Applicant, if different; and
- (iv) The application shall be signed by all property

owners of the subject land area, as currently recorded in the County Assessor's Office.

The Director shall have the authority to waive or add submittal requirements in cases where it is determined that the standard submittal information is not needed or if additional information is necessary to accomplish the objectives of this Code.

- c. **Recording.** Following approval of a limited lot line adjustment waiver, the Director and the City Engineer shall sign the appropriate submittal document(s). The applicant shall then record the documents(s) in the office of the County Clerk and be responsible for any associated fees. The applicant shall provide a copy of the recorded document(s) to the Director prior to the issuance of any building permit(s) for the subject land.

2.2 ZONING APPLICATIONS

- 2.2.1 Zoning Map Amendment
- 2.2.2 Planned Development - Regulating Plan and Development Master Plan
- 2.2.3 Site Plans
- 2.2.4 Conditional Use Approval
- 2.2.5 Administrative Use Approval
- 2.2.6 Temporary Use Approval
- 2.2.7 Special Use Approval
- 2.2.8 Assigned Zoning

2.2.1 Zoning Map Amendment

- a. **Intent.** Zoning map amendment procedures are intended to provide review of changes to zoning districts for a specific parcel or change to the boundary of a zoning district that may be appropriate based on specific development proposals, changed circumstances for the property and surrounding area, or changed public policy with respect to long-range plans.
- b. **Applicability.** An application for a zoning map amendment may be initiated by:
 - 1. The City Council on its own initiative;
 - 2. The Planning Commission or staff through a petition to the City Council, signed by the Chair of the Planning Commission or Director respectively; or
 - 3. The property owner(s), signed by the owner(s) or authorized agent of all property within the area proposed to be rezoned.
- c. **Specific Procedures.** A zoning map amendment has the following specific procedures:
 - 1. **Pre-application Conference.** A pre-application conference is not required, but is recommended for zoning map amendment applications, particularly for development that is complex or phased. The pre-application conference may discuss general development concepts, long-range planning issues and policies for the property or vicinity, and specific application procedures and requirements for a formal application.
 - 2. **Staff Review.** Upon receipt of a formal application staff will conduct an internal review and may forward copies of the application to any pertinent external agencies for review and comment.

- (a) *Complete Application.* Within 7 days of submittal of the application, staff shall determine whether the application is complete according to official application requirements. Staff shall notify the applicant in writing of any deficiencies in incomplete applications giving directions and deadlines to cure deficiencies. Staff shall schedule complete applications for a public hearing before the Planning Commission. The public hearing shall be scheduled for the next available Planning Commission meeting between 15 to 60 days of the determination of a complete application.
- (b) *Notice.* Prior to the Planning Commission public hearing the following notice shall occur:
- (1) *Posted Notice.* For applications initiated pursuant UDC subsections 2.2.1.b.1 or 2.2.1.b.2, signs indicating that there is a pending development application shall be posted generally delineating the boundaries of the area proposed for the zoning map amendment. Each sign shall include legible text stating that a "City-initiated Zoning Map Amendment" is proposed. For applications initiated pursuant to 2.2.1.b.3, staff shall provide 1 sign for each road frontage, to be posted by the applicant on each road frontage, indicating that there is a pending development application. All posted notices shall be posted at least 7 days prior to the scheduled Planning Commission review and the party responsible for posting the notice shall make reasonable and good efforts to maintain posted notice. When such efforts are made, failure of this posted notice will not be grounds to invalidate the application.
 - (2) *Published Notice.* Notice shall be published in a newspaper of general circulation and to the City of Cheyenne website at least 15 days but no more than 21 days prior to the scheduled Planning Commission review indicating the general location of the property, the nature of the application, the location for further information on that application, and the date, time and location of the Planning Commission review.
 - (3) *Mailed Notice.* All owners within 300' of subject property shall be mailed notice indicating the general location of the property, the nature of the application, the location for further information on that application, and the date, time and location of the Planning Commission public hearing. For applications initiated pursuant UDC subsections 2.2.1.b.1 or 2.2.1.b.2, the application shall mail notice to all properties within the proposed zoning map amendment area, in addition to the notice requirements of this section. When mailed notice is properly addressed based on the latest property information and deposited in the mail at least 15 days prior to the scheduled hearing, failure of a party to receive such notice will not be grounds to invalidate any action taken.
- (c) *Comments.* At least 7 days prior to the Planning Commission public hearing, staff shall forward formal comments on the application to the Planning Commission, including any external agency comments. A copy of the comments shall be submitted to the applicant at this time.
3. *Planning Commission Public Hearing.* Planning Commission shall review the application according to the criteria in this section. At the close of the public hearing the Planning Commission shall:
- (a) Recommend to the City Council that the application be approved;
 - (b) Recommend to the City Council that the application be approved with specific conditions or modifications;
 - (c) Recommend to the City Council that the application be denied, and state the specific reasons for denial; or
 - (d) Postpone the application to collect additional information pertinent to the application or to take the matter under advisement.
4. *City Council Review.* Upon a recommendation from the Planning Commission, the application shall be scheduled for review by the City Council according to the following:
- (a) *First Reading.* At the first regular meeting after the Planning Commission recommendation, the City Council shall conduct the first reading on the application. After the first reading, the Council may schedule a public hearing on the application at either a regular meeting OR a special meeting, at the Council's discretion. Notice shall be provided according the same requirements for the Planning

Commission public hearing.

(b) *Second Reading.* At least 15 days but no more than 35 days after the Planning Commission recommendation or close of any Council public hearing, the Council shall conduct the second reading on the application. After the first reading, the Council may schedule a public hearing on the application at either a regular meeting or a special meeting, at the Council's discretion. Notice shall be provided according the same requirements for the Planning Commission public hearing.

(c) *Final Reading.* At the first regular meeting after the second reading or close of any Council public hearing, the City Council shall conduct the final reading on the application. The Council shall:

- (1) Approve the application;
- (2) Deny the application, and state the specific reasons for denial; or
- (3) Postpone the application to collect additional information pertinent to the application or to take the matter under advisement.

5. *Protest Petition.* A formal protest may be filed protesting the Zoning Map Amendment application in accordance with applicable State Statutes. The formal protest shall be filed on a form provided by the City.

6. *Effect of Decision.* The decision by the City Council is the final decision. Upon approval of a zoning map amendment, the change shall be effective on the date of approval, or any other specific date in the ordinance approving the amendment.

d. **Review Criteria.** In reviewing, providing comments, and making recommendations and decisions on a proposed zoning map amendment, the staff, Planning Commission and City Council shall use the following criteria:

1. The application is in accordance with the development policies and physical patterns identified in the Comprehensive Plan.
2. The application is compatible with nearby property, specifically considering existing zoning, the Comprehensive Plan, and any other official plans and policies created under the guidance of that plan for these areas;
3. The suitability of the subject property for development according to the standards and uses of the existing zoning district, compared to the suitability of the

subject property for development according to the standards and uses of the proposed zoning district;

4. The ability of the subject property and surrounding vicinity to be developed according to the Subdivision Standards in Article 4 considering the proposed zoning;
5. The ability of the application to support the Intent and Applicability statements of the proposed zoning district, and achieve the Design Objectives of any specific standards.
6. The ability of all potential future development to meet all applicable standards for development in the proposed zoning district, including other development options in the event that any specific development proposed in association with the application is not executed after approval.
7. The review and recommendations of other reviewing bodies.
8. Whether the application will harm the public health, safety, or general welfare.

2.2.2 Planned Development - Regulating Plan or Development Master Plan

a. **Intent.** The planned development process is intended for developments that require a higher degree of specific planning based on the complexity of the development, the difficulty of integrating development into the site or vicinity, and the degree of flexibility desired from generally applicable development standards.

b. **Applicability.** The planned development procedures are applicable to applications that use the PUD zoning district or the Form-based Code standards in Article 7. An application for a planned development may be initiated by:

1. The City Council on its own initiative;
2. The Planning Commission or staff through a petition to the City Council, signed by the Chair of the Planning Commission or Director respectively; or
3. The property owner(s), signed by the owner(s) or authorized agent of at least 50% of all property within the area proposed to be rezoned, measured by both area and assessed value.

c. **Specific Procedures.** A planned development has the following specific procedures:

1. *Pre-application Meeting.* Prior to submittal of an

application the applicant shall schedule at least 1 pre-application meeting with the staff to discuss the subject property, long-range plans affecting the property and vicinity, general development concepts and goals anticipated to be part of an application, and procedures associated with executing a specific plan to guide future development.

2. *Conceptual Planning Meeting.* Prior to submitting a formal application and specific plan, at least one conceptual plan meeting shall be conducted by the applicant. This meeting shall require incorporation of the interests of surrounding property owners and the general public by either an invitation for participation of these individuals in the meeting, or by an opportunity for these individuals to review and comment on the outcomes of this conceptual planning meeting. The appropriate method shall be determined at the pre-application meeting. Additionally, staff shall make a determination on the need for City or other outside agency officials to participate in the conceptual planning meeting. This meeting satisfies the neighborhood meeting requirement referenced in Table 1-1. At a minimum, the conceptual planning meeting shall result in the following:
 - (a) An analysis of existing conditions on the site and the vicinity.
 - (b) A narrative statement of the vision, goals and objectives for development concepts to be applied to the property.
 - (c) Identification on how the vision, goals and objectives conform to the Comprehensive Plan.
 - (d) A proposal for how regulation of the property will be achieved consistent with the purposes, intent, design objectives of any zoning districts proposed for the project.
 - (e) A conceptual site plan identifying concepts on how these regulations will apply to the property, including the intensity and allocation of general uses on the site, and relationships to adjacent property.
 - (f) A conceptual site plan identifying development patterns, including potential street networks, open spaces, and access and circulation patterns, and relationships to adjacent property.
 - (g) One or more illustrations indicating the general urban design and architectural character sought for the plan, or for each sub-area of the plan

where the character will differ.

3. *Staff Review.* Following the Conceptual Planning Meeting the applicant may submit a formal application. The application shall include a preliminary development plan or program containing concepts, standards and phasing for the full build out of the subject property in three dimensions and a comprehensive review and documentation resulting from the conceptual planning meeting(s). Upon receipt of a formal application staff will conduct an internal review and may forward copies of the application to any pertinent external agencies for review and comment.
 - (a) *Complete Application.* Within 14 days of submittal of the application, staff shall determine whether the application is complete according to official submittal requirements. Staff shall notify the applicant in writing of any deficiencies in incomplete applications giving direction and deadlines to cure the deficiencies. Staff shall schedule complete applications for a public hearing before the Planning Commission. The public hearing shall be scheduled for the next available Planning Commission meeting between 15 and 60 days of the determination of a complete application.
 - (b) *Notice.* Prior to review by the Planning Commission the following notice shall occur:
 - (1) *Posted Notice.* For applications initiated pursuant UDC subsections 2.2.2.b.1 or 2.2.2.b.2, signs indicating that there is a pending development application shall be posted generally delineating the boundaries of the area proposed for the planned development. Each sign shall include legible text stating that a "City-initiated Planned Development" is proposed. For applications initiated pursuant to 2.2.2.b.3, staff shall provide 1 sign for each road frontage, to be posted by the applicant on each road frontage, indicating that there is a pending development application. All posted notice shall be posted at least 7 days prior to the scheduled Planning Commission review and the party responsible for posting the notice shall make reasonable and good efforts to maintain posted notice. When such efforts are

made, failure of this posted notice will not be grounds to invalidate the application.

- (2) *Published Notice.* Notice shall be published in a newspaper of general circulation and to the City of Cheyenne website at least 15 days but no more than 21 days prior to the scheduled Planning Commission review indicating the general location of the property, the nature of the application, the location for further information on that application, and the date, time and location of the Planning Commission review.
 - (3) *Mailed Notice.* All owners within 300' of subject property shall be mailed notice indicating the general location of the property, the nature of the application, the location for further information on that application, and the date, time and location of the Planning Commission public hearing. For applications initiated pursuant UDC subsections 2.2.2.b.1 or 2.2.2.b.2, the applicant shall mail notice to all properties within the proposed planned development area, in addition to the notice requirements of this section. When mailed notice is properly addressed based on the latest property information and deposited in the mail at least 15 days prior to the scheduled public hearing, failure of a party to receive such notice will not be grounds to invalidate any action taken
 - (c) *Comments.* At least 7 days prior to the Planning Commission public hearing, staff shall forward formal comments on the application to the Planning Commission, including any external agency comments. A copy of the comments shall be submitted to the applicant at this time.
4. *Planning Commission Public Hearing.* The Planning Commission shall review the application subject to the criteria in this section. At the close of the public hearing the Planning Commission shall:
 - (a) Recommend to the City Council that the application be approved;
 - (b) Recommend to the City Council that the application be approved with specific conditions or modifications;
 - (c) Recommend to the City Council that the application be denied, and state the specific reasons for denial; or
 - (d) Postpone the application to collect additional information pertinent to the application or to take the matter under advisement.
5. *City Council Review.* Upon a recommendation from the Planning Commission, the application shall be scheduled for review by the City Council according to the following:
 - (a) *First Reading.* At the first regular meeting after the Planning Commission recommendation, the City Council shall conduct the first reading on the application. After the first reading, the Council may schedule a public hearing on the application at either a regular meeting OR a special meeting, at the Council's discretion. Notice shall be provided according the same requirements for the Planning Commission public hearing.
 - (b) *Second Reading.* At least 15 days but no more than 35 days after the Planning Commission recommendation or close of any Council public hearing, the Council shall conduct the second reading on the application. After the first reading, the Council may schedule a public hearing on the application at either a regular meeting OR a special meeting, at the Council's discretion. Notice shall be provided according the same requirements for the Planning Commission public hearing.
 - (c) *Final Reading.* At the first regular meeting after the second reading or close of any Council public hearing, the City Council shall conduct the final reading on the application. The Council shall:
 - (1) Approve the application;
 - (2) Deny the application, and state the specific reasons for denial; or
 - (3) Postpone the application to collect additional information pertinent to the application or to take the matter under advisement.
6. *Protest Petition.* A formal protest may be filed protesting the Zoning Map Amendment application in accordance with applicable State Statutes. The formal protest shall be filed on a form provided by the City.
 7. *Effect of Decision.* The City Council decision is the final decision. Approval of the planned development shall constitute a zoning map amendment for the

property in the approved plan, subject to the specific zoning proposed with the plan. When the planned development application meets all of the submittal requirements and standards for a preliminary plat, approval of the development plan may also constitute acknowledgement and approval of a preliminary plat. Development of the property shall occur according to any administrative plat, final plat, site plan, or other specific procedures proposed as part of the development plan.

d. **Review Criteria.** In reviewing, providing comments, and making recommendations and decisions on a proposed planned development, the staff, Planning Commission and City Council shall use the following criteria:

1. The application meets all threshold requirements for application of the PUD District or Form-based Code standards.
2. The application presents clear and specific criteria on how the property and subsequent development will be reviewed, regulated and modified consistent with these regulations.
3. The application is in accordance with the development policies and physical patterns identified in the Comprehensive Plan.
4. The application reflects sound planning and urban design principles with respect to existing and potential future development in the vicinity, including consideration of current and future streets, open spaces, blocks and lots, and public utilities or facilities.
5. The application meets the purposes, intent, and all applicable standards in Article 4.
6. Any phasing proposed in the application is clearly indicated and demonstrates a logical and well-planned development pattern. This may include consideration of amenities and public facilities of the subdivision within each phase compared to the anticipated timing or the likelihood of future phases being constructed as planned.
7. The impacts identified in specific studies or technical reports that were prepared or requested to be prepared in association with the application, and whether the findings and recommendations of these reports, or any modifications or conditions on approval of the application, can mitigate these impacts.
8. The application is compatible with nearby property, specifically considering existing zoning, the Comprehensive Plan, and any other official plans and

policies created under the guidance of that plan for these areas.

9. The suitability of the subject property for development according to the standards and uses of the existing zoning district, compared with the suitability of the subject property for development according to the standards and uses of proposed zoning district.
10. The ability of the application to support the Intent and Applicability statements of the proposed zoning district, and achieve the Design Objectives of any specific standards.
11. The ability of all potential future development to meet all applicable standards for development in the proposed zoning district, including other development options in the event that any specific development proposed in association with the application is not executed after approval.
12. Whether the planning and urban design concepts, and any proposed deviation from or alternative to otherwise applicable development standards, result in clear public benefits, as opposed to benefits to existing or future land owners in the development.
13. The review and recommendations of other reviewing bodies.
14. Whether the application will harm the public health, safety, or general welfare.
15. The application is compatible with the character of the surrounding area in terms of building scale, building form, landscape, and site design.

2.2.3 Site Plan

a. **Intent.** The site plan process is intended to coordinate development projects with public improvements and with adjacent sites. Specifically it is intended to demonstrate that new development meets the development and design standards of these regulations.

b. **Applicability.** An application for a site plan shall be submitted by the owner or authorized agent where any of the following occur:

1. Any change of use or a new building.
2. Alterations to the site affecting over 15% of the non-building area of the site (examples include changes to parking, or open space and landscape areas).
3. Any other development activity or change of use that triggers applicability and compliance with any of the

Design Standards in Article 6.

4. Any other on-site development activity or change of use that triggers improvements in the public right-of-way and applicability and compliance with any of the Standards in Article 4.
 5. No site plan is required for single family, duplex, or townhouse development, except when associated with common lots associated with Cottage Lots or a Regulating Plan or Development Master Plan.
- c. **Specific Procedures.** An application for a site plan has the following specific procedures:
1. **Pre-application Conference.** A pre-application conference is not required but is recommended. The pre-application conference may be used to discuss design and development concepts, applicable standards, and application requirements and procedures.
 2. **Staff Review.** Upon submittal of a formal application, staff will conduct an internal review and may forward copies of the application to any pertinent external agencies for review and comment.
 - (a) **Complete Applications.** Within 7 days of submittal of the application, staff shall determine whether the application is complete according to official application requirements. Staff shall notify the applicant in writing of any deficiencies in incomplete applications giving directions and deadlines to cure the deficiencies. Staff shall schedule complete applications for formal internal review subject to the criteria in this section.
 - (b) **Posted Notice.** Not Required.
 - (c) **Final Decision.** Upon review according to the criteria in this section, and between 7 and 30 days of the determination of a complete application, the Director shall take one of the following actions:
 - (1) Approve the application;
 - (2) Approve the application with modifications or conditions. Modifications or conditions shall only be to better meet the standards and review criteria; or
 - (3) Deny the application and state the specific reasons for denial.
 3. **Effect of Decision.** The decision of the Director is the final decision and shall be given to the applicant in writing. Approval of the application shall be valid for 2 years. Any application that has not been acted upon within 2 years from approval shall be void. Denial of the application shall prohibit any activity on the plan, except that an application may be submitted to correct any specific deficiencies in the denied plan. The final decision may be appealed to the Board according to the criteria and procedures for appeal of an administrative decision in Section 2.3.3.
4. **Modifications to Site Plans.** The holder of an approved site plan may request a modification to the Approved Plan or the conditions of approval by submitting amended documents to the department. The amended documents shall be filed and processed in accordance with the procedures for an initial site plan review submittal.
- d. **Review Criteria.** In reviewing and making decisions on a proposed site plan approval, the Director shall use the following criteria:
1. The proposed application is consistent with any approved plat.
 2. The proposed application is adequately served by public services, or where not presently adequately served such service is either proposed in association with the plan or will be provided in coordination with development through capital improvements projects.
 3. The proposed application supports the Intent and Applicability statements of the proposed zoning district, and meets and achieves the Design Objectives of any specific standards. Any proposed relief from applicable standards shall be done according to the procedures and criteria offered in different sections of these regulations.
 4. The proposed application is consistent with any previously approved Regulating Plan or Development Master Plan. Minor deviations from those plans shall only occur as otherwise authorized by these regulations or as authorized in those specific plans.
 5. The proposed application contains no public health, safety or general welfare concerns that would warrant further consideration of this application by other authorities.
 6. Any review and recommendations of other reviewing bodies supports these findings.

2.2.4 Conditional Use Approval

- a. **Intent.** A conditional use approval process is intended to provide flexibility for different uses within a zoning district, and specifically allow the potential for additional uses that due to their varying design and operational characteristics may not be generally appropriate in a zoning district, but require case-specific review to determine the compatibility of the use, the associated site design, and the operational characteristics with surrounding uses and development patterns.
- b. **Applicability.** An application for a conditional use may be initiated by the property owner or authorized agent for any use within an existing or pending zoning district permitted as “conditional” in these regulations.
- c. **Specific Procedures.** Conditional use approval has the following specific procedures:
 1. **Pre-application Conference.** A pre-application conference is not required for conditional use approval, but may be used to discuss planning and urban design issues, and specific application procedures and requirements for a formal application.
 2. **Staff Review.** Upon receipt of a formal application staff will conduct an internal review and may forward copies of the application to any pertinent external agencies for review and comment.
 - (a) **Complete Application.** Within 7 days of submittal of the application, staff shall determine whether the application is complete according to official application requirements. Staff shall notify the applicant in writing of any deficiencies in incomplete applications giving directions and deadlines to cure deficiencies. Staff shall schedule complete applications for a public hearing before the Board of Adjustment. The public hearing shall be scheduled for the next available Board meeting between 15 and 60 days of the determination of a complete application.
 - (b) **Notice.** Prior to review by the Board the following notice shall occur:
 - (1) **Posted Notice.** Staff shall provide 1 sign for each road frontage indicating that there is a pending development application. The applicant shall ensure that 1 sign for each road frontage is posted on the property for at least 7 days prior to the scheduled public hearing. When the applicant has made all reasonable and good faith efforts to maintain posted notice, failure of this posted notice will not be grounds to invalidate the application.
 - (2) **Published Notice.** Notice shall be published in a newspaper of general circulation and to the City of Cheyenne website at least 15 days but no more than 21 days prior to the scheduled Board review indicating the general location of the property, the nature of the application, the location for further information on that application, and the date, time and location of the Board review.
 - (3) **Mailed Notice.** All owners within 300’ of subject property shall be mailed notice indicating the general location of the property, the nature of the application, the location for further information on that application, and the date, time and location of the Board public hearing. When mailed notice is properly addressed based on the latest property information and deposited in the mail at least 15 days prior to the scheduled hearing, failure of a party to receive such notice will not be grounds to invalidate any action taken.
 - (c) **Comments.** At least 7 days prior to the Board public hearing, staff shall forward formal comments on the application to the Board, including any external agency comments. A copy of the comments shall be submitted to the applicant at this time.
 3. **Board Public Hearing.** The Board shall review the application subject to the criteria in this section. Upon the close of the public hearing, the Board shall:
 - (a) Approve the application;
 - (b) Approve the application with specific conditions or modifications;
 - (c) Deny the application, and state the specific reasons for denial; or
 - (d) Postpone the application to collect additional information pertinent to the application or to take the matter under advisement.
 4. **Effect of Decision.** The decision by the Board shall be final. Approval by the Board shall be valid for 1 year. Any application that has not established the use

within one year from approval shall be void. Actions to establish use include building permits, certificate of occupancy, business licenses or commencement of other administrative processes necessary under City ordinance that demonstrate a substantial investment. Denial of the application shall bar any application for a conditional use that is not substantially different for at least 1 year. Any person aggrieved by a final decision of the Board may appeal the decision as provided in the Wyoming State Statutes.

d. **Review Criteria.** In reviewing, providing comments, and making recommendations and decisions on a proposed Conditional Use Approval, the staff and Board of Adjustment shall use the following criteria:

1. The application is compatible with the character of the surrounding area in terms of building scale, building form, landscape, and site design.
2. The operating characteristics of the use are complimentary to the character of the surrounding area in terms of hours of operation, visible and audible impacts, and traffic patterns caused by the use.
3. The suitability of the subject property for the use, compared with the suitability of the subject property for other uses permitted by right in the zoning district;
4. The specific application of the use to the site meets or exceeds the standards of the applicable zoning district. In meeting this criteria, the reviewing body may consider additional design standards in these regulations that are otherwise not applicable in the zoning district, but which based on the Design Objectives associated with the standard are relevant and comparable to the specific situation.
5. The specific application of the use to the site supports the Intent and Applicability of the zoning district, and does not compromise the Intent and Applicability of any adjacent zoning districts.
6. The long-range plans applicable to the site and surrounding areas, including the permanence of the proposed use in relation to the permanence of the surrounding uses in the area, and whether the proposed use is consistent with any changes in character occurring in the area.
7. The review and recommendations of other reviewing bodies.
8. Whether any additional site-specific conditions associated with the application are sufficient to prevent any potential harm to the public health, safety, or general welfare.

2.2.5 Administrative Use Approval

- a. **Intent.** An administrative use approval is intended to provide flexibility for different uses within a zoning district, and specifically allow the potential for additional uses that due to their varying design and operational characteristics may not be generally appropriate in a zoning district, but require case-specific review to determine the compatibility of the use, the associated site design, and the operational characteristics with surrounding uses and development patterns.
- b. **Applicability.** An application for an administrative use may be initiated by the property owner or authorized agent for any use within an existing zoning district permitted as "administrative" in these regulations.
- c. **Specific Procedures.** An application for an Administrative Use Approval has the following specific procedures:
 1. **Pre-application Conference.** Prior to submittal of an application the applicant shall schedule at least 1 pre-application meeting with the staff to discuss the eligibility of the application for administrative approval. Staff and the applicant shall discuss planning and urban design issues, and specific application procedures and requirements for a formal application.
 2. **Staff Review.** Upon submittal of a formal application, staff will conduct an internal review and may forward copies of the application to any pertinent external agencies for review and comment.
 - (a) **Complete Applications.** Within 7 days of submittal of the application, staff shall determine whether the application is complete according to official application requirements. Staff shall notify the applicant in writing of any deficiencies in incomplete applications giving directions and deadlines to cure the deficiencies. Staff shall schedule complete applications for formal internal review subject to the criteria in this section.
 - (b) **Posted Notice.** Not Required.
 - (c) **Final Decision.** Upon review according to the criteria in this section, and between 7 and 15 days of the determination of a complete application, the Director shall take one of the following actions:
 - (1) Approve the application; or
 - (2) Deny the application and state the specific reasons for denial.

3. *Effect of Decision.* The decision of the Director is the final decision and shall be given to the applicant in writing. Approval of the application shall be valid for up to 1 year. Any application that has not established the use within 1 year from approval shall be void. Actions to establish use include building permits, certificate of occupancy, business licenses or commencement of other administrative processes necessary under City ordinance that demonstrate a substantial investment. Denial of the application shall bar any application for an administrative use that is not substantially different for at least 1 year. The final decision may be appealed to the Board according to the criteria and procedures for appeal of an administrative decision in Section 2.3.3.
 - d. **Review Criteria.** In reviewing, providing comments, and making decisions on a proposed administrative use approval, the staff shall use the following criteria:
 1. The specific application of the use to the site is compatible with the character of the surrounding area in terms of building scale, building form, landscape, and site design.
 2. The operating characteristics of the use are complimentary to the character of the surrounding area in terms of hours of operation, visible and audible impacts, and traffic patterns caused by the use.
 3. The suitability of the subject property for the use, compared with the suitability of the subject property for other uses permitted by right in the zoning district.
 4. The specific application of the use to the site meets or exceeds the standards of the applicable zoning district. In meeting this criteria, staff may consider additional design standards in these regulations that are otherwise not applicable in the zoning district, but which based on the Design Objectives associated with the standard are relevant and comparable to the specific situation.
 5. The specific application of the use to the site supports the Intent and Applicability of the zoning district, and does not compromise the Intent and Applicability of any adjacent zoning districts.
 6. The long range plans applicable to the site and surrounding areas, including the permanence of the proposed use in relation to the permanence of the surrounding uses in the area, and whether the proposed use is consistent with any changes in character occurring in the area.
 7. The review and recommendations of other reviewing bodies.
- ### 2.2.6 Temporary Use Approval
- a. **Intent.** A temporary use approval is intended to provide flexibility for different uses within a zoning district, but due to the short duration, special conditions relative to the specific site, and other case-specific issues may be acceptable for a short and limited time.
 - b. **Applicability.** An application for a temporary use may be initiated by the property owner or authorized agent for any use within an existing zoning district that occupies the site on a non-continuous basis for more than 14 days.
 - c. **Specific Procedures.** An application for temporary use approval has the following specific procedures:
 1. *Pre-application Conference.* A temporary use shall require a pre-application conference. The applicant shall submit a short statement of the temporary use and an adequate site plan demonstrating all facilities associated with the temporary use, and their relation to surrounding property. Staff and the applicant shall discuss any planning and site design issues associated with the use.
 2. *Staff Review.* Upon submittal of a formal application, staff will conduct an internal review and may forward copies of the application to any pertinent external agencies for review and comment. Upon review according to the criteria in this section, and within 7 days of the determination of a complete application, the Director shall take one of the following actions and inform the applicant in writing:
 - (1) Approve the application;
 - (2) Deny the application and state the specific reasons for denial.
 3. *Effect of Decision.* The decision of the Director shall be final. Approval of the use shall require that a permit be displayed on the property for the duration of the use and must show the effective date and expiration of the permit. The final decision may be appealed to the Board according to the criteria and procedures for appeal of an administrative decision in Section 2.3.3.

ARTICLE 2

APPLICATIONS, PROCEDURES AND CRITERIA

2.2 ZONING APPLICATIONS

- d. **Review Criteria.** The Director shall not approve a temporary use unless the following criteria are met:
1. The specific application of the use to the site results in no new permanent facilities that are not otherwise allowed in the zoning district.
 2. The operating characteristics of the use are complimentary to the character of the surrounding area in terms of hours of operation, visible and audible impacts, and traffic patterns caused by the use.
 3. The suitability of the subject property for the use, compared with the suitability of the subject property for other uses permitted by right in the zoning district.
 4. The relation of the use to other existing uses on the site, including whether the site is being actively used.
 5. The specific application of the use to the site supports the Intent and Applicability of the zoning district, and does not compromise the Intent and Applicability of any adjacent zoning districts.
 6. The duration of the proposed use complies with the following time limits:
 - (a) Off-premise signage shall not exceed 30 consecutive days, shall not occur more than twice in a single calendar year, and shall have at least 15-days between consecutive occurrences.
 - (b) Temporary uses associated with a national, state, or local emergency declaration shall be allowed to operate during, and up to 90-days after conclusion, of said emergency. For the purposes of this section Temporary uses shall include temporary housing, in-patient medical care facilities, emergency medical facilities, support services, supply distribution centers, etc.
 - (c) All other temporary uses shall not be granted for more than 60- consecutive days and shall not occur more than twice in a 365-day period.
- b. **Applicability.** An application for a special use may be initiated by the property owner or authorized agent for any use requiring a "special use" approval in these regulations.
- c. **Specific Procedures.** Special use approval has the following specific procedures:
1. **Pre-application Conference.** A pre-application conference is not required, but may be used to discuss planning and engineering issues, and specific application procedures and requirements for a formal application and coordination of the Special Use Permit request with the Site Plan Review Process.
 2. **Staff Review.** Upon receipt of a formal application staff will conduct an internal review and may forward copies of the application to any pertinent external agencies for review and comment.
 - (a) **Complete Application.** Within seven (7) days of submittal of the application, staff shall determine whether the application is complete according to official application requirements. Staff shall notify the applicant in writing of any deficiencies in incomplete applications giving directions and deadlines to cure deficiencies. Staff shall schedule complete applications for formal internal review subject to the criteria in this section and any additional criteria required by the use.
 - (b) **Notice.** Prior to Review by the City Council the following Notice shall occur:
 - (1) **Posted Notice.** Prior to a recommendation, staff shall provide one sign for each road front age indicating that there is a pending development application. The applicant shall ensure that this sign is posted on each road frontage on the property for at least seven (7) days prior to the recommendation. When the applicant has made all reasonable and good faith efforts to maintain posted notice, failure of this posted notice will not be grounds to invalidate the application.
 - (c) **Staff Recommendation.** Upon review according to the criteria in this section and between 7 and 30 days of the determination of a complete application, the Director shall take one of the following actions
 - (1) Recommend approval of the application and place on the next available City Council agenda; or

2.2.7 Special Use Approval

- a. **Intent.** A special use approval process is intended to provide flexibility for different uses within a zoning district, and specifically allow the potential for additional uses that due to their varying design and operational characteristics may not be generally appropriate in a zoning district, but require case-specific review to determine the compatibility of the use, the associated site design, and the operational characteristics with surrounding uses and development patterns.

- (2) Recommend approval of the application with specific conditions or modifications and place on the next available City Council Agenda;
 - (3) Recommend Denial of the application and state specific reasons for denial.
 3. *City Council Approval and Acceptance.* Upon recommendation of the Staff, the application shall be scheduled for approval by the City Council at the next regular meeting. At this meeting City Council shall review the application subject to the criteria of this section and criteria for the special use and:
 - (a) Approve the Special Use Permit;
 - (b) Approve the Special Use Permit with specific conditions or modifications. Conditions or modifications shall be:
 - (1) to better meet standards and review criteria; or
 - (2) to address situations created by or aggravated by the proposed application, and which conditions are roughly proportional to the impacts of the proposed development;
 - (c) Deny the Special Use Permit.
 4. *Effect of Decision.* The decision of the Governing Body is the final decision. Any application that has not established the Special Use within 1 year shall be void.
- d. **Review Criteria.** In reviewing and making a decision on the Special Use Permit, the Governing Body and Staff shall consider:
1. Whether the operating characteristics of the use are complimentary to the character of the surrounding area in terms of hours of operation, visible and audible impacts, and traffic patterns caused by the use;
 2. The suitability of the subject property for the use, compared with the suitability of the subject property for other uses permitted by right in the zoning district;
 3. Whether the specific application of the use to the site supports the general intent and applicability of the zoning district, and does not compromise the general intent and applicability of adjacent zoning districts;
 4. The duration of the proposed Special Use relevant to the applicability requirements of this section;
 5. Whether any additional site specific conditions associated with the application are sufficient to prevent any potential harm to the public health, safety or general welfare;
 6. The review and recommendations of other reviewing bodies;
 7. Whether the use is in conflict with other applicable City, State or Federal regulations;
 8. The adequacy of infrastructure supporting the site.

2.2.8 Assigned Zoning

- a. **Intent.** The assigned zoning process is intended to provide review standards and procedures for zoning districts established on land or property currently without a City zone assignment.
- b. **Applicability.** An application for assigned zoning may be initiated by the Director for the following purposes:
 1. To assign a zone district to land being annexed to the City; or
 2. To assign a zone district to land which would become unzoned due to the termination of an existing zone district (e.g. a text amendment eliminating a zone district).
- c. **Specific Procedures.** An assigned zoning has the following specific procedures:
 1. *Staff Review.*
 - (a) For annexations, following the submittal of an annexation petition, the Director shall assign a zone that best matches the lands current county zone accompanying the annexation of a property. Staff shall make available to the public a policy document indicating what city zone is most analogous to the county zones. This policy document shall be available online and may be amended from time to time. (Should the applicant who has initiated the annexation desire a different zone than that of the zone best matched to the land's current county zone, the applicant may submit a zoning map amendment in accordance with the provisions of UDC Section 2.2.1.) Staff shall then schedule a public hearing before the Planning Commission to consider the assigned zoning. The public hearing shall be scheduled for the Planning Commission meeting immediately preceding the City Council public hearing for the related annexation.

ARTICLE 2

APPLICATIONS, PROCEDURES AND CRITERIA

2.2 ZONING APPLICATIONS

(b) For zoning terminations, the Director shall assign a zone that best matches the current zoning of the property. Staff shall schedule the public hearing before the Planning Commission to coincide with the action terminating the zone district.

2. **Notice.** Staff shall follow the notice requirements below for the assigned zone:

(a) **Posted Notice.** For applications initiated by the City, signs indicating that there is a pending development application shall be posted generally delineating the boundaries of the area of land proposed for the zoning. Each sign shall include legible text stating that a "Zoning Map Amendment" is proposed. For applications initiated by a property owner's request for annexation, staff shall provide one (1) sign for each road frontage, to be posted by the applicant on each road frontage, indicating that there is a pending development application. All posted notices shall be posted at least seven (7) days prior to the scheduled Planning Commission review and the party responsible for posting the notice shall make reasonable and good faith efforts to maintain the posted notice. When such efforts are made, failure of this posted notice shall not be grounds to invalidate the application.

(b) **Published Notice.** Notice shall be published in a newspaper of general circulation and to the City of Cheyenne website at least fifteen (15) days but no more than twenty-one (21) days prior to the scheduled Planning Commission review stating the general location of the property, the nature of the application, the location for further information on that application, and the date, time and location of the Planning Commission review.

(c) **Mailed Notice.** All owners within three hundred (300) feet of subject property and within the subject area shall be mailed notice stating the general location of the property, the nature of the application, the location for further information on that application, and the date, time and location of the Planning Commission public hearing. When mailed notice is properly addressed based on the latest property information available from the publicly accessible assessors map and deposited in the mail at least fifteen (15) days prior to the

scheduled hearing, failure of a party to receive such notice shall not be grounds to invalidate any action taken.

3. **Planning Commission Public Hearing.** The Planning Commission shall review the application according to the criteria in this section. At the close of the public hearing the Planning Commission shall:

(a) Recommend to the City Council that the application be approved; or

(b) Recommend to the City Council that the application be approved with specific conditions or modifications; or

(c) Recommend to the City Council that the application be denied, stating the specific reasons for denial.

4. **City Council Review.** Upon a recommendation from the Planning Commission, the application shall be scheduled for review by the City Council in accordance with the procedures specified in the municipal code. The Assigned zoning shall be introduced such that the final approval of the assigned zoning is aligned with the approval of the document creating the situation requiring the assigned zoning.

5. **Effect of Decision.** The decision by the City Council is the final decision.

(a) After the approval of an any zoning assignment that accompanies an annexation, the assigned zoning shall be effective at the same time as the annexation.

(b) After the approval of any zoning assignment that accompanies a zone termination, the assigned zoning shall not be effective prior to the termination of the previous zone.

d. **Review Criteria.** In reviewing, providing comments, and making recommendations and decisions on a proposed assigned zone, the staff, Planning Commission and City Council shall use the following criteria:

1. The proposed zoning assignment is the most analogous City zone to the current zone when taking into consideration allowed uses. Zoning for standard county zones shall be assigned based on the policy document, while zones not listed on the policy document and terminated City zones shall be assigned a City zone on a case-by- case basis.

2.3 APPEALS AND RELIEF

- 2.3.1 Subdivision Standard Waiver
- 2.3.2 Zoning Variance
- 2.3.3 Appeal of an Zoning Administrative Decision
- 2.3.4 Administrative Adjustment

2.3.1 Subdivision Standard Waiver

- a. **Intent.** A subdivision standard waiver is intended to provide relief from the strict application of a standard where a different technical or design solution on a specific site would better meet the intent of the regulations or where a new and emerging technical or design solution has proven to achieve better results than the standard.
- b. **Applicability.** An application for a subdivision standard waiver may be initiated by the property owner or authorized agent for relief from any technical standards in Article 4. The subdivision waiver may be processed in association with any plat or site plan application. Waivers will not be issued for procedural requirements.
- c. **Specific Procedures.** A subdivision standard waiver has the following specific procedures:
 1. **Pre-application Conference.** Prior to submittal of an application the applicant shall schedule at least 1 pre-application conference with the staff to discuss the eligibility of the application for the waiver.
 2. **Staff Review.** Upon submittal of a formal application, staff will conduct an internal review and may forward copies of the application to any pertinent external agencies for review and comment.
 - (a) **Complete Applications.** Within 7 days of submittal of the application, staff shall determine whether the application is complete according to official application requirements. Staff shall notify the applicant in writing of any deficiencies in incomplete applications giving directions and deadlines to cure the deficiencies. Staff shall schedule complete applications for formal internal review subject to the criteria in this section.
 - (b) **Final Decision.** Upon review according to the criteria in this section, and after consultation with the Director, the City Engineer shall take one of

the following actions:

- (1) Approve the application;
- (2) Approve the application with conditions, modifications or time limits;
- (3) Deny the application and state the specific reasons for denial.

The decision shall be made in conjunction with the decision on any associated plat or site plan, or where not associated with a plat or site plan the decision shall be made within 21 days of a complete application.

3. **Effect of Decision.** The decision of the City Engineer is the final decision and shall be given in writing, unless processed in association with a plat or plan, in which case the City Engineer's decision shall become part of the record. Approval of the application shall be valid for up to 1 year. If not acted on and recorded within 1 year the approval shall be void. A denial of the application may be appealed to the Planning Commission and City Council according to the same procedures as a final plat.
- d. **Review Criteria.** In approving a subdivision standard waiver the City Engineer shall find that the application meets all of the following criteria:
 1. The application meets acceptable standards of practice for engineering, operation and safety.
 2. The application will not unnecessarily negatively impact the purposes, intent and design objectives of other design standards on the property and on adjacent property.
 3. The application equally or better meets the standards for which the waiver is requested, or alternatively, the applicant demonstrates that the standard for which the waiver requested is applicable to the specific site based on proper engineering, site planning, and urban design practice.
 4. The application would not otherwise negatively impact other standards on the site or adjacent sites.
 5. The application is supported by documentation that demonstrates that any proposed new technology, innovations, or alternative standards are successful at meeting the purpose and intent of the standard.
 6. The application meets the public interest, and is not otherwise prohibited by other city, state or federal laws.
 7. The waiver is the minimum necessary to address

proper site development and public facility design and construction, including the duration of any temporary waivers if necessary

2.3.2 Zoning Variance

- a. **Intent.** A zoning variance is intended to provide relief from the strict application of a standard where application of the standard to a specific site would create an unnecessary hardship or practical difficulties on all reasonable use of the property.
- b. **Applicability.** An application for a zoning variance may be initiated by the property owner or authorized agent for relief from any zoning standards in Article 2, Article 5, Article 6, or Article 7 of these standards. Zoning variances are not applicable to vary the use allowed on property.
- c. **Specific Procedures.** A zoning variance has the following specific procedures:
 1. **Pre-application Conference.** A pre-application conference is not required for a zoning variance, but may be used to discuss specific application procedures, criteria and requirements for a formal application.
 2. **Staff Review.** Upon receipt of a formal application staff will conduct an internal review and may forward copies of the application to any pertinent external agencies for review and comment.
 - (a) **Complete Application.** Within 7 days of submittal of the application, staff shall determine whether the application is complete according to official application requirements. Staff shall notify the applicant in writing of any deficiencies in incomplete applications giving directions and deadlines to cure deficiencies. Staff shall schedule complete applications for a public hearing before the Board of Adjustment. The public hearing shall be scheduled for the next available Board meeting between 15 and 60 days of the determination of a complete application.
 - (b) **Notice.** Prior to review by the Board the following notice shall occur:
 - (1) **Posted Notice.** Staff shall provide 1 sign for each road frontage indicating that there is a pending development application. The applicant shall ensure that 1 sign for each road frontage is posted on the property for at least 7 days prior to the scheduled public hearing. When the applicant has made all reasonable and good faith efforts to maintain posted notice, failure of this posted notice will not be grounds to invalidate the application.
 - (2) **Published Notice.** Notice shall be published in a newspaper of general circulation and to the City of Cheyenne website at least 15 days but no more than 21 days prior to the scheduled Board review indicating the general location of the property, the nature of the application, the location for further information on that application, and the date, time and location of the Board review.
 - (3) **Mailed Notice.** All owners within 300' of subject property shall be mailed notice indicating the general location of the property, the nature of the application, the location for further information on that application, and the date, time and location of the Board public hearing. When mailed notice is properly addressed based on the latest property information and deposited in the mail at least 15 days prior to the scheduled hearing, failure of a party to receive such notice will not be grounds to invalidate any action taken
 - (c) **Comments.** At least 7 days prior to the Board public hearing, staff shall forward formal comments on the application to the Board, including any external agency comments. A copy of the comments shall be submitted to the applicant at this time.
 3. **Board Public Hearing.** The Board shall review the application subject to the criteria in this section. Upon the close of the public hearing, the Board shall:
 - (a) Approve the application;
 - (b) Approve the application with specific conditions or modifications;
 - (c) Deny the application, and state the specific reasons for denial; or
 - (d) Postpone the application to collect additional information pertinent to the application or to take the matter under advisement. When postponed, new notice shall be required. The continued hearing shall occur at the next Board of Adjustment regular meeting, or at some other time within 60 days with the consent of the applicant. No application may be postponed more than once by the Board without the applicant's consent.

4. *Effect of Decision.* The decision by the Board shall be final and issued in writing. Approval by the Board shall be valid for 1 year. Any application that has not been acted on within one year from approval shall be void. Acting on the application includes building permits, certificate of occupancy, business licenses or commencement of other administrative processes necessary under City ordinance that demonstrate a substantial investment. Denial of the application shall bar any application for a variance that is not substantially different for at least 1 year. Any person aggrieved by a final decision of the Board may appeal the decision as provided in the Wyoming State Statutes.
- d. **Review Criteria.** The Board shall not approve a variance unless it finds the application meets the following criteria:
 1. There are special circumstances or conditions that are peculiar to the land or building for which the adjustment is sought and do not apply generally to land or buildings in the neighborhood, and have not resulted from any act of the applicant subsequent to the adoption of the code such as irregularity, narrowness, or shallowness of lot, or exceptional topographical conditions;
 2. The circumstances or conditions are such that the strict application of the provisions of the code would deprive the applicant of the reasonable use of the land or building;
 3. The granting of the adjustment is necessary for the reasonable use thereof and the adjustment as granted is the minimum adjustment that will accomplish this purpose;
 4. The granting of the adjustment is in harmony with the general purposes and intent of the Code and will not be injurious to the neighborhood or otherwise detrimental to the public welfare.

2.3.3 Appeal of Zoning Administrative Decision

- a. **Intent.** An appeal of an administrative decision is intended to provide an opportunity to be heard and grant relief when a final decision by an administrative official made in interpreting and applying the zoning provisions in these regulations was an error.
- b. **Applicability.** An application for an appeal of an administrative decision may be initiated by any person aggrieved by a final administrative decision made by an

administrative official interpreting and applying the zoning provisions of Articles 5 and 6. The appeal shall be:

1. Made in writing and submitted to the Director stating the specifics of the appeal, the grounds for the requested relief, and include all pertinent records of the decision.
 2. Made within 14 days of the final decision.
 3. Demonstrate that the decision is final and that all other administrative remedies have been exhausted.
- c. **Specific Procedures.** An appeal of an administrative decision has the following specific procedures:
1. *Pre-application Conference.* A pre-application conference is not required for an appeal of an administrative decision, but may be used to discuss specific application procedures, criteria and requirements for a formal application.
 2. *Staff Review.* Upon receipt of a formal application staff will conduct an internal review and may supplement the application with any additional records on the decision.
 - (a) *Complete Application.* Within 7 days of submittal of the application, staff shall determine whether the application is complete according to official application requirements. Staff shall notify the applicant in writing of any deficiencies in incomplete applications giving directions and deadlines to cure deficiencies. Staff shall schedule complete applications for a public hearing before the Board of Adjustment. The public hearing shall be scheduled for the next available Board meeting between 15 and 60 days of the determination of a complete application.
 - (b) *Mailed Notice.* Notice of the appeal shall be mailed to any interested party on record in the decision. When mailed notice is properly addressed based on the latest property information and deposited in the mail at least 15 days prior to the scheduled hearing, failure of a party to receive such notice will not be grounds to invalidate any action taken.
 - (c) *Comments.* At least 7 days prior to the Board public hearing, staff shall forward the application, formal comments, and other pertinent records on the decision to the Board. A copy of the comments shall be submitted to the applicant at this time.

3. **Board Public Hearing.** The Board shall review the application subject to the criteria in this section. Upon the close of the public hearing the Board shall:
 - (a) Affirm the decision of the administrative official;
 - (b) Affirm the decision of the administrative official with specific conditions or modifications;
 - (c) Overturn the decision of the administrative official and make the decision that the Board determines should be made. No decision of the Board may exceed the authority granted to the administrative official under these regulations; or
 - (d) Postpone the application to collect additional information pertinent to the application or to take the matter under advisement. When postponed, new notice shall be required. The continued hearing shall occur at the next Board of Adjustment regular meeting, or at some other time within 60 days with the consent of the applicant. No application may be postponed more than once by the Board without the applicant's consent.
 4. **Effect of Decision.** The decision by the Board shall be final and issued in writing. Any person aggrieved by a final decision of the Board may appeal the decision as provided in the Wyoming State Statutes.
 - d. **Review Criteria.** In reviewing and deciding on an appeal of an administrative decision the Board shall use the following criteria:
 1. Whether the decision of the administrative official was a clear error, as opposed to fairly debatable, according to the provisions of these regulations.
 2. The interpretation instructions of these regulations.
 3. The purposes, intent, and design objectives of any standards that are subject to the appeal.
 4. The record on the application, including the official plans and policies of the City used to evaluate the application or make the decision.
 5. Whether the final decision and the grounds for relief requested in the appeal are within the authority granted by these regulations.
 6. Whether there are other more appropriate and applicable procedures to achieve the applicant's proposed objective, such as a plan amendment, text amendment, planned zoning districts, a zoning map amendment, or a variance.
- ### 2.3.4 Administrative Adjustment
- a. **Intent.** The administrative adjustment process is intended to provide flexibility for application of specific standards to sites where it is clear that an alternative approach with minor or de minimis modifications of the standards will equally or better meet the purpose, intent or design objectives of these regulations.
 - b. **Applicability.** An application for administrative adjustment may be submitted by the owner or authorized agent in association with a site plan. Administrative adjustments have the following specific eligibility requirements:
 1. **Alternative Compliance.** Any design or dimension standard in these regulations that specifically includes considerations for alternative compliance subject to the review by the Director, and which gives criteria or parameters for the alternative compliance.
 2. **Planned Development Adjustments.** Any minor adjustments for a Form-based Code or PUD, which is not anticipated in the approved preliminary development plan and:
 - (a) increases the proposed density by 5% or less; or
 - (b) reduces the proposed public or common open space by 3% or less; or
 - (c) increases the proposed building footprint by 5% or less; or
 - (d) increases the proposed building height by 10% or 3', whichever is less, for buildings within 100' of the plan boundary; or
 - (e) increases the proposed building height by 20% or 10', whichever is less, for buildings more than 100' from the plan boundary.
 3. **Other Minor Adjustments.** Adjustments to any other dimensional or design standard that result in no perceived impact on abutting property and where flexibility in the standards will help promote reuse or rehabilitation of existing buildings and lots. In no case may an adjustment of more than 50% of any dimensional standard be considered to have "no perceived impact."
 - c. **Specific Procedures.** Applications for administrative adjustments shall follow the same procedures required for a site plan. The decision of the Director shall be given to the applicant in writing, and a copy shall be made available for public review.

- d. **Review Criteria.** In considering an administrative adjustment, the Director shall find that all of the following criteria exist:
1. The relief requested is compatible with the character of the surrounding area in terms of building scale, building form, landscape, and site design.
 2. The relief requested supports the Intent and Applicability statements of the zoning district, and meets and achieves the Design Objectives of any specific standards.
 3. The relief requested is based upon sound planning or urban design principles that are professionally recognized and consistent with the Comprehensive Plan.
 4. The relief requested is based on the context of the property, is not solely for the convenience of one particular application on the site, and is not generally applicable to other sites in the area.
 5. The relief requested is the minimum necessary to meet the Intent and Applicability of the zoning district and the Intent of the Administrative Adjustment process.
 6. The relief requested does not alter the general concept of any preliminary development plan or regulating plan applicable to the property, and specifically preserves the design excellence or outstanding public amenity that was the basis for the PUD or regulating plan.
 7. The relief requested is within any specific bounds of discretion granted by these regulations, or where no such bounds are specified results in only a minor modification of the standard that produces no perceived impact on abutting property.
 8. Any review and recommendations of other reviewing bodies supports these findings.

2.4 TEXT AMENDMENTS AND ANNEXATIONS

- 2.4.1 Text Amendments
2.4.2 Annexations

2.4.1 Text Amendments

- a. **Intent.** Text amendments are intended to insure that the generally applicable laws contained in the Unified Development Code reflect the broad public interests, long-range planning goals, and general health, safety and welfare of the community.
- b. **Applicability.** The text amendment process is applicable to any change in the provisions of these regulations and may be initiated by:
 1. The City Council on its own initiative;
 2. The Planning Commission on its own initiative; or
 3. The Director or City Engineer on their own initiative.
- c. **Specific Procedures.** A text amendment shall require the following specific procedures:
 1. **Staff Review.** Prior to submittal to the Planning Commission, a text amendment shall require a review and report by Staff. Staff may submit the application to any pertinent outside agencies or other entities for review and comment. Staff shall schedule text amendments for one or more a public hearings with the Planning Commission.
 2. **Published Notice.** Notice shall be published in a newspaper of general circulation and to the City of Cheyenne website at least 15 days but no more than 21 days prior to the scheduled Planning Commission review indicating the general the nature of the amendment, the location for further information on that amendment, and the date, time and location of the Planning Commission review.
 3. **Planning Commission Public Hearing.** The Planning Commission shall review the amendment according to the criteria in this section. Upon the close of the public hearing(s), the Planning Commission shall:
 - (a) Recommend to the City Council that the amendment be approved;

- (b) Recommend to the City Council that the amendment be approved with modifications;
 - (c) Recommend to the City Council that the amendment be denied, and state the specific reasons for denial; or
 - (d) Postpone the amendment to collect additional information pertinent to the amendment or to take the matter under advisement. When postponed, new notice shall be required. The continued hearing shall occur at the next Planning Commission regular meeting, or at some other time within 60 days.
4. *City Council Review.* Upon a recommendation from the Planning Commission, the amendment shall be scheduled for review by the City Council according to the following:
- (a) *First Reading.* At the first regular meeting after the Planning Commission recommendation, the City Council shall conduct the first reading on the amendment. After the first reading, the Council may schedule a public hearing on the application at either a regular meeting or a special meeting, at the Council's discretion. Notice shall be provided according the same requirements for the Planning Commission public hearing.
 - (b) *Second Reading.* At least 15 days but no more than 35 days after the Planning Commission recommendation or close of any Council public hearing, the Council shall conduct the second reading on the amendment. After the first reading, the Council may schedule a public hearing on the amendment at either a regular meeting or a special meeting, at the Council's discretion. Notice shall be provided according the same requirements for the Planning Commission public hearing.
 - (c) *Final Reading.* At the first regular meeting after the second reading or close of any Council public hearing, the City Council shall conduct the final reading on the amendment. The Council shall:
 - (1) Approve the amendment;
 - (2) Deny the amendment, and state the specific reasons for denial; or
 - (3) Postpone the amendment to collect additional information pertinent to the application or

to take the matter under advisement. When postponed, new notice shall be required. The continued hearing shall occur at the next City Council regular meeting, or at some other time within 60 days.

- d. **Review Criteria.** Review of a text amendment shall be according to the following criteria:
 - 1. The amendment is in accordance with general goals and policies of the Comprehensive Plan, or is necessary to address an emerging issue not anticipated in the Comprehensive Plan and is not inconsistent with the plan.
 - 2. The amendment is consistent with the Wyoming Statutes, and specifically the Municipal Planning and Zoning statutes.
 - 3. The amendment promotes the general health, safety and public welfare.

2.4.2 Annexations

- a. Annexations to the City of Cheyenne shall be administered in accordance with Wyo. Stat. §§ 15-1-401 *et seq.*
- b. Zoning assignments for land being annexed to the City shall be established in accordance with the procedures specified by 2.2.8 of this code. Should the applicant for the annexation prefer to change the zone from the zone assigned by UDC Section 2.2.8, the applicant may file for a zoning map amendment pursuant to UDC Section 2.2.1 concurrently with the annexation and assigned zoning.

This page is intentionally left blank.

ARTICLE 3 IMPACT STUDIES

3

Article 3, Impact Studies provides tools and evaluation techniques for complex development projects. It includes coordination of design and funding of public improvements in response to specific development applications. It is most useful to large developers, land planners, design professionals and engineers.

UNIFIED DEVELOPMENT CODE

ARTICLE 3 IMPACT STUDIES

- 3.1 Transportation Impact Studies
- 3.2 Drainage Impact Studies
- 3.3 [RESERVED]

3.1 Transportation Impact Studies

- 3.1.1 General Provisions
- 3.1.2 Levels of Study
- 3.1.3 Study Parameters
- 3.1.4 Evaluation Elements

3.1.1 General Provisions

- a. **Purposes.** In addition to the general purposes of these regulations, this Article has the following specific purposes. To:
1. Assess the impact which a new development, change in land use, zone change, or an access modification will have on the existing and proposed transportation system, both at the immediate location and in the general area.
 2. Provide information and guidance as plans are developed and decisions made for the approved plan.
 3. Determine the travel demand generated by a proposed development.
 4. Identify deficiencies in the existing and proposed transportation systems.
 5. Assess pedestrian, bicycle, transit and truck connections as a critical component of managing transportation systems.
 6. Identify improvements necessary to maintain acceptable levels of service.
 7. Minimize burdens on the public that result from transportation impacts of proposed development.
 8. Ensure that transportation and land use decisions are linked in accordance with the Comprehensive Plan of the City, and the long-range transportation plans for the community.

b. **Applicability.** Except as specified below in Section 3.1.2, the requirements of this Article apply to:

1. A change in land use;
2. A proposed zoning change;
3. Modification of access points to public streets; and
4. Development or subdivisions of land.

c. **Applicant Responsibilities.** An applicant for any applicable development application shall have the following responsibilities:

1. **Transportation Worksheet.** A Transportation Worksheet (Appendix C) shall be completed and submitted with all applications for development approval. No worksheet is required for residential projects proposing 25 dwelling units or less and instigating no substantial access changes on a collector or arterial roadway.
2. **Scoping Meeting.** After the applicant has completed the Transportation Worksheet, the applicant shall contact the Planning and Development Department and arrange for a meeting to determine base assumptions and the level of TIS required.
 - (a) **Purpose.** The scoping meeting shall determine the parameters for the study of transportation impacts for a specific development project, and document those parameters. The parameters determined in the scoping meeting represent general agreement between the City and the applicant, but they may not be all inclusive. The City retains the right to require any additional pertinent transportation information and/or analysis to complete the evaluation of the proposed development project.
 - (b) **Determination of Study.** The City and applicant and where applicable WYDOT or the County shall mutually agree to the level of detail and extent to which the study addresses each of the following:
 - (1) Study area for the impact analysis.
 - (2) Other developments within the study area.
 - (3) Existing intersection counts.
 - (4) Intersections to be studied in detail.
 - (5) Background traffic volume forecasts (Buildout: 20 to 25 years).

- (6) Transit, bicycle, or pedestrian issues such as location and design of transit stops, pedestrian and bicycle access to transit stops, major bicycle or pedestrian destinations such as schools, parks and neighborhood activity centers, or other similar multi-modal considerations.
 - (7) Special analysis needs (non-traditional peak hour volumes for some uses, neighborhood impacts, access management plans, or other traffic reduction programs).
 - (8) Data availability and requirements. Conclusions of the scoping meeting will be documented and distributed to the applicant by the City.
3. **Preparation of Study.** The applicant is responsible for the study, which shall be prepared by a qualified traffic engineer who is specialized in the preparation of Transportation Impact Studies and is licensed by the Wyoming State Board of Registration for Professional Engineers and Professional Land Surveyors to practice engineering in Wyoming.
 4. **Study Presentation.** Four copies of the traffic study shall be submitted. Reports shall be 8½" x 11" format, with maps no larger than 11" x 17". Additional copies may be required for large or complex projects. The exact number required should be verified at the scoping meeting.
- d. **City Responsibilities.** The City and its engineering staff serve in a review capacity. The City can use the findings of the impact study to suggest or require roadway improvements, changes to site design, and/or operational improvements. The applicant shall revise and resubmit the study as necessary to address review comments provided to the applicant by the City or other affected agencies.
- ### 3.1.2 Levels of Study
- The following levels of analysis apply: (These categories are intended as guidelines and may be revised, when warranted, by the City Engineer.)
- a. **No Transportation Impact Assessment or Study Required.** The City Engineer may elect to not require a study in the following circumstances:
 1. **Exception.** A Transportation Impact Assessment or Study is not required for residential projects consisting of less than 50 dwelling units and instigating no substantial access changes on a collector or arterial roadway.
 2. **Waiver.** Upon submittal of a Transportation Worksheet (Attachment C) by the applicant and written acceptance by the City Engineer, the study requirement may be waived if all of the following are satisfied:
 - (a) Daily vehicle trip-end generation is less than 500 and the peak-hour trip generation is less than 50;
 - (b) There are no additional access requirements on collectors, arterials, or State Highways;
 - (c) The increase in the number of vehicular trips for the proposed use does not exceed the trip generation from the existing use by more than 20 peak-hour trips or 200 daily vehicle trip-ends;
 - (d) Any change in the type of traffic to be generated (i.e., the addition of new truck traffic) does not adversely affect the traffic currently planned for, accommodated within and adjacent to the property;
 - (e) The scale or use of the proposed development or redevelopment is not likely to cause less-than-acceptable levels of service on the adjacent public streets, accesses, and intersections; and,
 - (f) The proposed development or redevelopment is not in the vicinity of a street or intersection with a history of safety and/or accident problems.
 - b. **Transportation Impact Assessment.** A Transportation Impact Assessment (TIA), in lieu of a more detailed study, will be considered if both of the following requirements are met:
 1. Daily vehicle trip-end generation is between 500 and 1,000, and/or the peak-hour trip generation is between 50 and 100; and
 2. Any new access requests are for local streets.
 - c. **Transportation Impact Study.** A full Transportation Impact Study (TIS) may be required for any development that meets one of the following criteria:
 1. Daily vehicle trip-end generation is greater than 1,000 or the peak-hour trip generation is greater than 100;
 2. Access(es) designated as high-volume driveways (50 peak-hour trips) onto Arterials or State Highways are being requested; or
 3. Where large, complex projects are planned or a

project is phased over a multi-year build-out, it may be appropriate to prepare a TIS for the initial land-use action followed by periodic updates for specific phases. The TIS must include overall phasing of improvements to coincide with project phasing. Updates to the TIS shall be submitted with the land-use applications for the specific phases.

- d. **Revisions or Updates.** A revision or update to an approved TIS may be required when previously approved land-use action proposes an expansion, a change to access, or a change in use where new trip generation estimates exceed the original trip-end generation estimates. If the currently approved study was prepared within the last two years, an amendment letter addressing the changes may be accepted and satisfy the requirements of this guideline. The letter must address:
1. An estimate of site trip generation;
 2. Existing site trip generation; and
 3. The differences between anticipated estimates and existing trip generation.

If the original study is older than two years and access and trip generation has not changed, then an amendment to the TIS is required. If the original study is older than two years, and access has changed or trip generation has increased, then an entirely new study will be required by the City Engineer.

Original Report is -	Access Changed* or Trip Generation Increased	Access Not Changed and Trip Generation Not Increased
<i>Less than 2 years old</i>	Letter Amendment Required: Identify and discuss any items that changed	Letter documenting change (no other reports required).
<i>Greater than 2 years old</i>	New Study	Letter Amendment Required: 1. New local ground counts 2. New Trip Generation 3. New LOS Analysis 4. Meet all current requirements of this TIS guideline

* Changed access includes proposed new access or refinement of general access locations not specially addressed in original proposed development.

3.1.3 Study Parameters

- a. **Summary.** The Summary shall be provided as a condensed, stand-alone document. Maps and tables required or provided in individual sections of the report shall be placed in the Summary in the order described and provided in the text of the report. Individual sections of the report may be referenced only as necessary to document a source of information.
- b. **Project Description.** A description of the proposed project shall include the type of land use and size of the proposed project (number of dwelling units or building square footage), proposed phasing, and anticipated completion date. A figure depicting the proposed site plan shall also be included, and the proposed vehicular access locations will be described. This figure shall provide the following:
1. Surrounding street roadway arterial classification
 2. Number of existing and proposed travel lanes
 3. Existing and proposed street width
 4. Existing and proposed right-of-way dimensions
 5. Existing and proposed multi-use driveways and site access points (with turning movements)
 6. Traffic control
 7. Speed limits
 8. Existing and proposed access
 9. Locations of parks, schools, activity centers, and other notable destinations within 1/4 mile of the project edge, and

identify sidewalks, bike routes, lanes, or paths that would be used to get from the project to each destination. Also identify how pedestrian and bicycle access is provided within the project site to facilities at the boundaries.

10. Cheyenne city bus routes and stops.

Similar information for adjacent property shall be provided as well, if available, on the same map. The data presented in this report shall be identical in every respect to the site plan submitted for development approval. For situations where a site plan does not exist, a prototypical site roadway and access system should be assumed for purposes of the study. Subsequent updates will be necessary when a site plan becomes available. This section will also include a description of how pedestrian and bicycle travel will be accommodated within the proposed site plan. This section will also identify how access to the Cheyenne Transit Program (CTP) is provided.

c. **Analysis Horizons.** Three study horizons are required for a Master or Full TIS analysis:

1. Existing (current);
2. Short-range (one year after build-out); and
3. Long-range (20 to 25 years, based on current Cheyenne Area Master Transportation Plan).

It may be acceptable for the short-range and long-range horizons to be identical for some large projects.

d. **Study Area.** The limits of the transportation network to be studied shall be based on the size and extent of the application for development approval, the existing and future land uses and traffic conditions on and near the site. The exact limits of the study area are to be based on good engineering and transportation planning judgment, and an understanding of existing and future land use and traffic conditions at and around the site. The limits of the study area shall be agreed upon at the scoping meeting. At a minimum, the factors to be considered for the establishment of limits of the study should include:

1. All adjacent streets, intersections, and high-volume driveways;
2. Nearest offsite major intersection(s);
3. Internal roads, including establishing the road classification;
4. Pedestrian and bicyclist destinations (existing or planned) within 1,320 feet of the site;
5. Any pedestrian or bicycle routes within 1½ mile of a school (residential land uses only) and

6. Any Cheyenne public bus routes and stops within 1,320' of the project.

e. **Existing and Proposed Uses in Vicinity of Site.** The applicant shall identify existing and anticipated land uses in the general vicinity of the site in order to understand other influences to area traffic patterns. A list of the applicable development approvals shall be included. (This information shall be obtained from the City's records.) Specific attention shall be paid to property adjacent to the site and any undeveloped land in the study area. A map shall be prepared for the project vicinity that graphically depicts the location of approved or proposed developments. Developments within the project study area but in other jurisdictions shall also be identified and documented on the map.

f. **Existing and Committed Transportation Improvements.** The applicant shall prepare a map showing the planned surface transportation improvements for the short-term and long-term planning horizons. Committed/funded improvements by the City and previously approved developments shall be identified for the short- and long-term horizon years. The long-term improvements shall be those documented in the City's Transportation Master Plan and any other long-term improvements adopted through the Cheyenne MPO and/or included in the State Transportation Improvement Program. The description of improvements shall include the nature, extent, implementation schedule, and the party responsible for the improvement.

3.1.4 Evaluation Elements

TISs and TIAs shall utilize sound and commonly accepted traffic engineering standards and procedures and shall utilize the latest edition of the Institute of Transportation Engineers (ITE) trip generation rates—unless better information is available or can be obtained at reasonable cost. TISs and TIAs shall address the following items in sufficient detail (based on the agreed-upon parameters outlined in the scoping meeting) to adequately and accurately represent the traffic conditions and resultant impact of the proposed development request.

a. **Transportation Impact Study.** The key elements of the project impact study (TIS) shall include the following evaluations:

1. *Conformity with the adopted Transportation Master Plan.* The applicant shall identify the roadway

improvements within the study area per the City’s Transportation Master Plan.

2. *Existing Traffic Conditions.* The applicant shall provide a description of the existing traffic conditions within the study area and shall include the following:
 - (a) *Traffic Counts.* A map shall be prepared, which presents a.m. and p.m. peak-hour and daily traffic volumes. These volumes shall be no more than two years old — less if the development is in a high-growth area. The source of existing traffic volume information shall be explicitly stated (City counts, new counts by applicant, County counts, etc.). Summaries of current traffic counts shall be included in the description’s appendix.
 - (b) *Existing Peak-hour and Daily Level of Service.* Existing a.m. and p.m. peak-hour intersection levels of service shall be determined for signalized and unsignalized intersections within the study area based on procedures described in the latest edition of the Highway Capacity Manual. The existing arterials shall also be analyzed based on a daily volume/capacity ratio analysis where the threshold capacities are defined by arterial designation per the following table. Volume/capacity ratios that exceed 1.00 shall be identified. It should be noted that these are general thresholds for planning purposes only, and a supplementary peak-hour analysis shall be considered. These daily volume/capacity ratios shall be recorded on the existing volume map. Roadway links shall be analyzed. Acceptable maximum traffic volumes allowed for the specific class of roadways are per the following table:

Facility Type	Lanes	Threshold Capacity
Local Residential	2	2,500 ADT
Local Commercial / Industrial	2	3,500 ADT
Collector	2	7,500 ADT
Minor Arterial	2	550 each way peak hour
Arterial	4	1,600 each way peak hour

It is recognized that some of the City’s streets currently experience traffic volumes greater than each roadway’s classification design volume. The objective of this analysis is to identify whether the

volume (as a point of reference for considering impacts from the proposed development) exceeds the threshold.

- (c) *Crash Analysis.* A three-year accident record shall be collected for adjacent roadways and intersections within the study area. Based on existing traffic volumes, an accident rate for accidents per million vehicle miles of travel for links and accidents per million vehicles at intersections shall be calculated by year. Geometric deficiencies for high-accident locations shall be identified. As part of the analysis, the applicant shall identify problems that currently exist and how the proposed improvements will mitigate these problems.
3. *Future Traffic Conditions without Proposed Development.* Long-term a.m. and p.m. peak-hour and daily link planning horizon traffic forecasts shall be estimated. The short-term planning horizon is one year after full occupancy. The short-term planning horizon traffic forecast shall be the sum of existing traffic volumes plus cumulative development traffic plus ambient growth. The short-term planning horizon traffic forecasts shall also include cumulative development traffic within the study area. The short-term planning horizon year ambient growth-rate traffic forecasts shall be based on:
 - (a) Proportion between existing traffic volumes and build-out regional (Wyoming Department of Transportation) model forecasts;
 - (b) Extrapolation from historical traffic counts to current counts, and/or
 - (c) Planning analysis that considers trends in the area’s circulation system through either a proportion or extrapolation estimate.

Whatever method is used to develop the annual growth rate for determining ambient traffic, it is important that the method be documented with sufficient detail to clarify the methodology and replicate the findings. The map of the committed and funded improvements (for each planning horizon) shall be used as a base for determining short-term and long-term planning horizon levels of service. The applicant may identify improvements that would mitigate unacceptable levels of service under the traffic conditions without the proposed development. In addition to needed improvements, identification of when such improvements are needed is also

important. The time that improvements are necessary could be defined by when a traffic threshold is reached or by potential year.

4. *Trip Generation.* Development traffic shall be analyzed based on the traditional trip generation, distribution, and assignment process described as follows:

(a) *Project Trip Generation.* The applicant shall estimate project trip generation (total daily traffic and a.m./p.m. peaks) for interim years and build-out based on the development approval application number and size of units. Trip generation shall be calculated from the latest data contained within the Institute of Transportation Engineers' Trip Generation Report or other industry publications such as the ITE Journal. Data limitations, data age, choice of peak-hour or adjacent street traffic, choice of independent variable and choice of average rate versus statistical significant modification shall be presented and discussed. In the event that data is not available for a proposed land use, the applicant shall conduct a local trip generation study following procedures prescribed in the ITE Trip Generation Manual and shall provide sufficient justification for the proposed generation rate. This rate must be acceptable to the City Engineer. For shopping centers, trip generation shall be based on both the shopping center trip generation algorithms and the application of trip generation rates to individual land uses. The greater of the two methods shall be used in the analysis.

(b) *Adjustments to Trip Generation Rates.* After first generating trips at full ITE rates, trip-making reduction factors may be used. These factors fall into two categories:

(1) *Reassignment of Trips:* This category of adjustments applies when trips to the proposed development currently exist as part of the background traffic stream, referred to as a pass-by trip. Pass-by percentages identified in the ITE Trip Generation Manual or other industry publications may be used. This traffic must continue to be assigned to site driveways and access points, but is not additive to the background stream of traffic. A technical appendix that illustrates the redirection of pass-by trips is recommended.

(2) *Remove or Move Trips:* This category of adjustments is for internal site trips, transit use, and TDM (transportation demand management) actions. In general, reductions are not recommended. However, if reductions are claimed, analytic support to show how the figures were derived must be provided.

In all cases, the underlying assumptions of the ITE Trip Generation rates must be specifically described in order for these reductions to be considered and claimed. Optimistic assumptions regarding transit use and TDM actions will not be acceptable unless accompanied by specific implementation proposals that will become a condition of approval. Such implementation proposals must have a reasonable expectation of realization within a 5-year period after project initiation.

(c) *Trip-generation Budget.* Major concern will occur if the traffic study identifies a trip-generation rate that is less than what ultimately is experienced once the development is built and occupied. Because entitlement has been granted, the impacts of the traffic from underestimating the trip generation is experienced by the community; modifications or improvements, if possible, become the burden of the public. It is recognized that the trip generation process is ultimately dependent on a number of market and social factors; however, it is imperative that the traffic impact study be sufficiently conservative to account for full impact of the proposed development.

5. *Trip Distribution.* Trip distribution may be based on the WYDOT modeling, market analysis, existing traffic flows, applied census data, and professional judgment. Regardless of the estimates, the procedures and logic for estimating the trip distributions must be well documented. The trip distribution patterns must be presented for each phase if changes in roadway network, access or land use are proposed.

6. *Project Trip Assignment.* This section shall present the forecast of the traffic assignment based on the development's trip generation estimates and project trip distribution. The traffic forecasts shall be graphically presented and include: a.m. peak-hour,

p.m. peak-hour, and total daily site-generated traffic. If trip generation is different for the short-term and long-term planning horizons, both shall be shown on separate graphics. "Pass by" traffic shall be included at driveways and access points.

7. *Future Traffic Forecasts with the Proposed Development.*

The applicant shall present a graphical summary of the short-term and long-term horizon year traffic plus the proposed development traffic for the a.m. peak-hour, p.m. peak-hour, and daily conditions. These volumes shall include turn movements at the key intersections. The base map for this exhibit shall reflect the respective transportation network by planning horizons.

8. *Future Peak-hour Level of Service and/or Peak-hour Intersection and Driveway Level of Service.* An a.m. and p.m. peak-hour intersection level of service analysis shall be conducted for study-area intersections and driveways. This analysis should be based on procedures established in the most current Highway Capacity Manual. Synchro intersection level of service is both acceptable and desirable to assess the impacts of intersection levels of service as part of a system of signalized intersections. Levels of service for signalized intersections shall be based on the signal timings developed for the signal progression analysis. All level of service analysis worksheets shall be included in the Appendix of the submitted study. The principal objective of the intersection level of service traffic impact analysis is to identify whether the traffic from the proposed project when added to the existing, plus short- and long-term planning horizon traffic, will result in a significant impact and an unacceptable level of service. For definition purposes, the threshold for acceptable level of service is C. Significance is defined as: 1) when the added project traffic causes the level of service to deteriorate below level of service D, or 2) when the short-term or long-term horizon year traffic without the project is below level of service D and the project traffic causes a 2% increase in the volume/capacity ratio or delay. For unsignalized intersections, the minimum level of service permitted for outbound left turns is E. An analysis of maximum queue length shall also be performed; and if the queue exceeds five vehicles, then a separate left-turn lane with adequate storage shall be provided.

9. *Appropriateness of Access Locations and Circulation.* The TIS shall address the appropriateness of the proposed access points. This assessment shall be consistent with requirements set forth in Articles 4 and 6 of these regulations. If the proposed access is to be signalized, then a progression analysis using Synchro shall be conducted to insure that the proposed access can be accommodated within the optimum progression along the roadway on which the access is proposed.
10. *Identification and Location for Turn Lanes or Acceleration/Deceleration Lanes at Accesses or Intersections.* The TIS shall identify recommendations and reasons for acceleration and deceleration lanes—including taper lengths, storage length, and other geometric design requirements per Articles 4 and 6 of these regulations.
11. *Sight Distance.* The TIS shall provide an evaluation and recommendation for intersection and driveway stopping sight distance and intersection sight distance per Articles 4 and 6 of these regulations.
12. *Pedestrian and Bicycle Analysis.* The TIS shall provide in sufficient detail the project's proposal to provide pedestrian and bicycle connections within the site to the local off-site pedestrian and bicycle destinations, using the Pedestrian and Bicycle Guidelines in Appendix E. These destinations include, but are not limited to, schools, parks, local commercial centers, and bike trails. This written and mapped assessment shall describe the directness of the route to and from various parts of the project, the continuity of the pedestrian and bicycle system to reach these destinations and the design elements of the street crossings to assure safe pedestrian and bicycle crossings. If the continuity between the project's pedestrian and bicycle system and that of the off-site destination is incomplete, the applicant shall identify what improvements are necessary to mitigate these continuity or street-crossing impacts. It is further required that if any roadway improvements are proposed, such as adding a left- or right-turn lane, the study should address methods to mitigate the impacts on the pedestrian and bicycle system in these areas—explaining how the routes are to cross these proposed improved streets and intersections. Locations for crosswalks, both internal and external to the site, shall be identified.

13. *Cheyenne Public City Bus Connections.* The applicant shall contact the Cheyenne Public City Bus Office to determine existing and future bus transit routes and stops within the study area. Specific stops within or adjacent to the site (such as signs, pads, shelters, etc.) shall be identified as proposed improvements. This analysis shall also identify direct and continuous pedestrian sidewalks and pathways to reach these stops from the site.
 14. *Traffic Control.* The TIS shall provide recommended traffic-control devices for intersections; these may include stop-control and yield-control signs, school flashers, crosswalks, traffic signals or roundabouts. These recommendations shall be in conformity with the City standards, AASHTO and other appropriate professional transportation engineering documents. All proposed signal and stop signs shall require a signal or stop sign warrant analysis per the Manual on Uniform Traffic Control Devices. As signal warrants only describe the minimum requirements for considering a signal, a progression analysis shall be conducted to determine that the impact of the new signal can be accommodated without significant impact to the corridor's signal progression.
 15. *Progression Analysis for Signalized Intersections.* A progression analysis is required for all projects which propose the addition of a new signal. Whereas the signal warrant analysis identifies the minimum requirements of whether a signal might be warranted, the signal warrant analysis does not determine if the signal can be accommodated in the overall traffic flow of the corridor. Therefore, the acceptability of the signal locations must be demonstrated through a signal progression (time-space) analysis. The analysis shall consider any existing access or intersections or a possible future signal location along the arterial for a distance of at least one mile in each direction of the proposed signal. (This data is available from the City.) The maximum cycle length that will be permitted is 110 seconds. A travel speed of 45 mph on Principal Arterials and 35 mph on Minor Arterials, unless the existing posted speed limit is less, should be used. A Principal Arterial bandwidth of 50% and a Minor Arterial bandwidth of 40% are considered desirable and must be used where existing conditions allow. Where intersections or other accesses have no signals presently, but are expected to have signals, a 60% mainline, and 40% cross-street cycle split should be assumed. Where more detailed information is available from turning movement projections, other split assumptions may be made. Any access that would reduce the desirable bandwidth if a traffic signal were installed shall be identified. In general terms, that access should remain unsignalized and have turning movements limited by driveway design or median islands, unless the impacts to traffic operation and safety are made even worse by doing so. Distances between signalized intersections (centerline) shall be indicated. Signal progression worksheets (time-space diagrams) shall be included in the Appendix of the submitted study. If it is determined that the minimum green band is reduced by five percent or less, then the signal would be permitted. If the green band for the arterial is reduced by greater than five percent, then the intersection design will need to be modified or relocated to minimize the impact.
 16. *Other items as requested by the City Engineer.* In the initial required scoping meeting with the City Engineer, specific additional issues might be raised which require further analysis. Additional concerns might include cut through traffic and residential quality-of-life concerns, truck/bus traffic estimates and pavement design, routes to schools, emergency routes, etc.
- a. **Transportation Impact Assessment.** At a minimum, the following issues shall be considered for submittal in a TIA. Requirements for these issues are defined in the above section on TIS requirements.
 1. Existing Traffic Conditions:
 - (a) Traffic Counts,
 - (b) Traffic Growth,
 - (c) Crash Analysis,
 - (d) Peak-hour level of service and/or peak-hour intersection and driveway level of service,
 - (e) Future peak-hour level of service and/or peak-hour intersection and driveway level of service, and
 - (f) Appropriateness of access locations.
 2. Location and requirements for turn lanes or acceleration/deceleration lanes at the access, including recommendations for taper lengths, storage lengths, and other geometric design requirements per City or WYDOT requirements,
 3. Sight distance evaluations and recommendations

- (intersection, stopping, passing),
4. Continuity and adequacy of pedestrian and bike facilities within the study area,
 5. Existing and future transit routes and stops in the area,
 6. Appropriateness of the existing roadway signing and striping,
 7. Other items as requested by the City Engineer and agreed upon in consultation with the Applicant's traffic engineer, and
 8. Neighborhood and public input issues.
- c. **Mitigation/Alternatives.**
1. *Improvement Descriptions.* TISs and TIAs shall describe the location, nature, and extent of all transportation improvements that the applicant recommends to yield reasonable operating conditions in each horizon year with the land-use action approved as requested. To identify mitigation and alternatives, the following terms apply:
 - (a) Planned: Improvements that are already planned and have committed funding, including those identified in short-term capital improvement programs by the City, State, or others.
 - (b) Applicant Committed: When existing plus cumulative traffic, with planned and background improvements, results in unacceptable levels of service, the applicant shall identify mitigation measures to offset project impacts.
 - (c) Necessary: Improvements required to mitigate background plus applicant traffic to establish acceptable levels of service, regardless of the amount of traffic contributed by the project.

The reason that "necessary" improvements must be explored is that often the "planned" improvements, plus the improvements that the applicant typically understands and commits to, are not adequate to provide a satisfactory level of service. The applicant shall assure that all practical solutions have been considered when developing the list of "necessary" improvements, so that the resulting operating conditions will approach the accepted level of service.
 2. *Transportation Network Plan and Recommended Improvements.* The applicant shall provide a scaled drawing of the recommended improvements on a transportation network plan. One sheet may be used for both interim and long-term design years if all the improvements can be conveniently described. If not, one or more sheets should be completed for each design year.
 - (a) In general the acceptable level of service for all post-development transportation systems is C. However, all applicable modes of transportation shall be considered and the function of the entire network shall be evaluated in the analysis and recommended improvements, including the Pedestrian and Bicycle Guidelines in Appendix E.
 - (b) Examples of vehicular traffic considerations and improvements include: road widenings, turn lanes, acceleration and deceleration lanes, intersection improvements, traffic control, design-speed adjustments, modifications to access points and truck routes.
 - (c) Examples of pedestrian and bicycle considerations and improvements include: safe, comfortable, and convenient pedestrian services, shorter blocks, tree-lined sidewalks, smaller corner radii, well-defined crosswalks, median refuges, bike lanes, on-street parking and shared-use path connections. Also, design elements that lead to low traffic speeds on local streets should be considered.
 3. *Costs.* For purposes of identifying improvement possibilities (either by the applicant, City, or State) necessary to yield an acceptable level of service, the cost of the improvements shall not be considered a limiting constraint within the context of the study. However, the goal of the evaluation is to identify cost-effective solutions that yield a reasonable level of service. Extremely high-cost solutions may not be cost-effective, but it is important to at least identify solutions so decision makers are cognizant of existing options.
 4. *Design Details.* All recommended improvements shall include right-of-way needs (for roadways), signal or turn-lane improvements (for intersections), and, at a sketch planning level, cost of the improvement. Also, commitment to the improvement shall be identified, either by local governments, districts, or by the applicant (this may include both the "applicant committed" and "necessary" projects). Identification of a project as "not currently committed" may be an appropriate description for many needed projects, including some of those that are "planned." However, the goal of the recommendations shall be to identify a firm program of improvements that will support the

proposed land-use action and background traffic in each design year.

It is further required that all geometric improvements, such as pavement markings, signs, adding through or turn lanes, adding project access and assorted turn lanes, acceleration lanes, and changes in medians, shall be presented in a schematic scaled drawing, preferably on a current aerial map. Sufficient dimensions shall be identified to facilitate review.

4. Mitigate increases in stormwater runoff rates and volumes due to development, wherever possible, through stormwater management controls.
5. Ensure that stormwater management controls pose no threat to public safety and are properly maintained.

b. **Applicability.** This Sub-article 3.2 applies to all land development activities, including platting, re-platting, zoning, re-zoning, site plan applications, grading permit applications, and other development activities. This Sub-article is not applicable to the maintenance of existing pavement (streets, parking lots, etc.).

c. **Waiver.** A request for a waiver of the requirement to submit a drainage impact study shall be made in writing to the City Engineer. The City Engineer shall review the request and either: grant the waiver; specify the level of drainage impact study necessary for approval of a particular proposed development action; or deny the request for waiver. The City Engineer may waive the requirement to submit a drainage impact study based on the following:

1. Information is provided to substantiate there are no potential drainage problems at the site or downstream of the site (including impacts to downstream floodplains).
2. The development or redevelopment will not create drainage problems.
3. The development or redevelopment will not result in an increase in the impervious area.
4. The development or redevelopment of an area is immediately adjacent to a major drainageway that is capable of conveying the fully developed basin 100 year flood without impact to the base flood elevation.

d. **Applicant Responsibilities.**

1. All responsibilities for the planning, design and construction of drainage improvements required in conjunction with land development shall be vested in the person or party who is developing the land (developer).
2. The developer shall be responsible for obtaining all required approvals and permits from regulatory entities (i.e. City, County, State, and Federal agencies) and shall comply with all applicable statutes pertaining to water quality and water pollution control.

3.2 Drainage Impact Studies

- 3.2.1 General Provisions
- 3.2.2 Levels of Study
- 3.2.3 Drainage Design
- 3.2.4 Study Reports
- 3.2.5 Final Acceptance of Drainage Improvements
- 3.2.6 Maintenance
- 3.2.7 Grading and Erosion Control Permit
[Reserved]

3.2.1 General Provisions

- a. **Purposes.** In addition to the general purposes of these regulations, this Section establishes minimum stormwater management requirements and controls to protect the general health, safety, and welfare of the public residing in watersheds within the City. These regulations:
1. Assure stormwater facilities are planned and designed to minimum criteria.
 2. Minimize increases in nonpoint source runoff and pollution caused by stormwater runoff from development to reduce flooding, erosion, increases in stream temperature and maintain the integrity of existing stormwater systems.
 3. Treat stormwater runoff at the source by preserving or enhancing natural flow paths and vegetative cover, preserving or enhancing natural open spaces and riparian areas, disconnecting impervious surfaces, and other measures that replicate pre-development hydrologic conditions to preserve the natural hydrologic functions, stream characteristics and groundwater recharge to the maximum extent practical.

3. The developer shall be responsible for securing approval of a final drainage report and approval of construction plans prior to City issuance of a Grading Permit and prior to construction of any drainage improvements. The requirement for approval of a drainage report will not apply to proposed land disturbance activities or projects where the requirement for a drainage impact study has been waived.
- e. **City Responsibilities.**
1. The City and its engineering staff serve in a review capacity. The City may use the findings of the impact studies to suggest or require drainage improvements, changes to site design, and operational improvements. The applicant shall revise and resubmit the study as necessary to address review comments provided to the applicant by the City or other affected agencies.
 2. The City shall have the right to designate surface water storage areas to serve large land areas, which may include multiple subdivisions, developments and land owners. This right may be exercised when the applicable Drainage Master Plan has designated areas for storage as part of the overall surface water plan, or when, in the opinion of the City Engineer, a single storage facility serving a large area is more efficient to construct, less expensive to maintain, or more easily adapted to multiple land uses.
 3. In such cases, the City Engineer may initiate an Improvement District or utilize the reimbursement provisions of Chapter 1.16 of the Cheyenne City Code as a means of constructing the required improvements. When the Developer constructs these improvements that directly benefit other areas or properties, the Developer may utilize the reimbursement provisions of Chapter 1.16 of the Cheyenne City Code.
- are waived, except as provided by Subsection e. of this Section.
- b. **Infill or re-development 20,001 sf to 40,000 sf.** A Drainage Impact Study shall be completed and the Water Quality Capture Volume (WQCV) shall be treated in a post-construction BMP. Detention requirements to control the peak discharge are waived, except as provided by Subsection e. of this Section.
 - c. **Infill or re-development 40,001 sf to 75,000 sf.** A Drainage Impact Study shall be completed, the WQCV shall be treated in a post-construction BMP, and detention for the 10-year storm shall be provided. Detention requirements to control the 100-year peak discharge are waived, except as provided by Subsection e. of this Section.
 - d. **Infill or re-development greater than 75,000 sf or new development greater than 20,000 sf.** A Drainage Impact Study shall be completed and all water quality and detention requirements shall be complied with to the maximum extent feasible.
 - e. A waiver may not be available if: 1) the site is located in an area of known drainage problems; 2) the site is located within a floodplain; 3) there is a channel, swale, or other drainage conveyance on the site; or 4) the topography immediately downstream from the site obstructs the run-off in a way that may cause risk to buildings or roadways.

3.2.3 Drainage Design

- a. **General.**
1. Design shall preserve existing natural features, drainage features and historical flow patterns to the extent they can be incorporated into the site development plan and fit the context and urban design principles for the general area.
 2. Drainage facilities shall be designed and constructed in accordance with accepted engineering practices. Primary resources include the City Construction Specifications, the current adopted City Stormwater Management Manual and the current UDFCD Urban Storm Drainage Criteria Manual (UDFCD Manual).
 3. Provisions shall be made in the planning and development of land to provide for the mitigation of surface water run-off increases due to

3.2.2 Levels of Study

The following levels of analysis apply.

- a. **Less than 20,000 square feet (sf).** For new, infill, or re-development with a total area of the project site less than 20,000 sf when all phases are complete the Developer shall complete the Drainage Worksheet. Drainage Impact Studies and detention and water quality requirements

development. Mitigation shall be provided to the extent that the peak rate of flow from the project area after development exceeds the specified peak rate of flow prior to development, in accordance with the design standards as established herein.

- (a) The City Engineer is authorized to require a lower allowable discharge rate in specific basins or sub-basins if, in the exercise of professional judgment, a lower allowable discharge rate is required to prevent additional adverse impacts on downstream properties. A lower allowable discharge rate shall be documented in writing and be supported by reproducible engineering calculations, referenced to the Drainage Master Plan.
- (b) An individual development will not be required to provide mitigation, or may provide partial mitigation if it can be demonstrated, subject to City approval, that: (1) the increased volume and rate of runoff caused by a proposed development, when considered in combination with other existing or planned developments or land uses, will not cause the design criteria specified in this Sub-article 3.2 to be exceeded; or (2) the required mitigation is provided in an off-site facility.

4. City rainfall Intensity-Duration-Frequency information is presented in Table 1 and Figure 1.

Duration (Minutes)	Rainfall Intensity (inches per hour)					
	(2 Yr)	(5 Yr)	(10 Yr)	(25 Yr)	(50 Yr)	(100Yr)
5	3.42	4.75	5.70	6.98	8.00	9.07
10	2.64	3.66	4.38	5.40	6.12	6.90
15	2.20	3.04	3.60	4.36	4.96	5.56
30	1.34	1.96	2.42	3.06	3.56	4.12
60 (1 hr.)	0.73	1.10	1.41	1.87	2.27	2.73
120 (2 hr.)	0.41	0.63	0.83	1.16	1.46	1.84
1440 (24 hr.)	0.06	0.08	0.10	0.13	0.15	0.18

Data Source: USGS Water Resources Investigation (WRI) 87-4225 Precipitation Records and Flood-Producing Storms, Cheyenne, Wyoming.

5. Drainage planning and design shall evaluate rainfall event frequencies of a 5-Year, 10-Year, 50-Year, and 100-Year peak runoff. Design rainfall events from drainage master plans, Federal Emergency Management Agency (FEMA) Flood Insurance Studies,

and subsequent references to those documents shall generally be accepted. Engineers, designers and developers should contact the City Engineer for appropriate design parameters early in the planning stages of a project.

- 6. Drainage planning shall provide for conveyance from areas upstream of, and within, a project to be sized for a 100-Year frequency storm event.
- 7. All drainage improvements shall be designed to convey a minimum of the Minor Storm, with provisions for the conveyance of the Major Storm as outlined in Table 2 below:

Zoning District/Land Use	Minor	Major
Parks/Open Public Lands	2-Year	100-Year
Agricultural/Rural Residential	5-Year	100-Year
Urban Residential	5-Year	100-Year
Commercial	10-Year	100-Year
Industrial	10-Year	100-Year

- 8. Drainage facilities shall be designed to minimize mosquito breeding.
- 9. Potential impacts of groundwater or sub-surface water shall be quantified, to the extent possible, and considered during drainage planning and design.
- 10. The developer shall be responsible for obtaining approvals for new bridges and large span culverts from the Wyoming Department of Transportation.
- 11. To ensure proper construction, maintenance, and access to the drainage system, drainage easements shall be provided in all areas traversed by channels, storm sewers and detention or storage areas.
- 12. Existing stormwater management facilities on redevelopment sites are not required to be retrofitted to meet the current design standards if the existing facilities remain hydraulically isolated from the redevelopment area.
- 13. The City encourages the use of LID principles.

b. Design Criteria and Parameters.

- 1. Storm Sewers
 - (a) Storm sewers shall not be designed to surcharge in the minor storm (surcharge is a depth of flow greater than 80 percent of the height). The maximum hydraulic head shall be 0.5 feet below the lip of drop inlets for the minor storm.

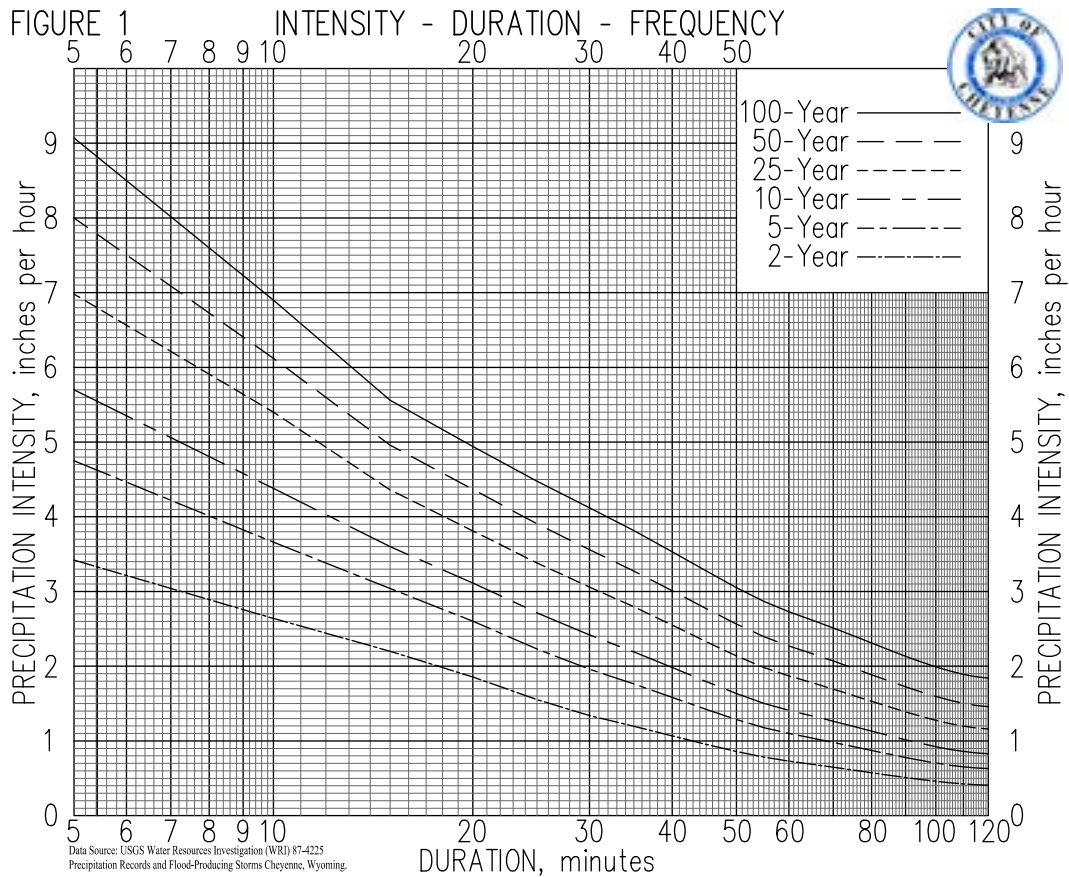

- (b) Minimum velocity is 3 feet per second (fps) at 25 percent of height. Maximum velocity is 18 fps, or in accordance with manufacturer specifications.
- (c) Manholes shall be placed at junctions, or wherever there is a change in size, direction, or grade. Maximum spacing is 350 feet.
- (d) Minimum clearance between adjacent pipes within manholes or inlets is 12 inches (measured outside to outside).
- (e) All conduits 54" and greater shall have headwalls and wingwalls. Smaller conduits shall have headwalls and wingwalls or flared-end sections. Flared-end sections shall require joint fasteners and toe walls extending 3 feet below the invert.
- (f) Headwalls and wingwalls shall have guardrails, handrails, or fencing in conformance with local building codes and roadway safety requirements. Handrails shall be required in areas frequented by pedestrians or bicycles. Handrail heights shall be

- 42 inches for pedestrian walkways or open areas, and 54 inches for bicycle traffic.
 - (g) Maximum headwater depth is 1.5 times the storm sewer height for the design storm ($HW/D = 1.5$). This criteria does not apply to stormwater detention pond outlets.
 - (h) Storm sewer flows exceeding 5 fps velocity or 5 feet of depth shall provide outlet protection. Outlets shall be protected with riprap, concrete or a stilling basin in accordance with the UDFCD Manual.
 - (i) Storm sewers and appurtenant structures within anticipated drive areas shall be designed to withstand HS-20 loading.
2. Channels
- The following criteria apply to proposed channels with a 100-year discharge exceeding 100 cfs.
- (a) Channels shall be designed for the 100-year flood assuming a fully developed watershed, with freeboard of 1.0 foot. The freeboard is measured vertically from the design water surface elevation

to the top of bank. Freeboard requirements do not apply to swales designed in accordance with the UDFCD Manual.

- (b) Grass-lined channels are desirable. A low-flow channel with a minimum capacity of 1/3 the 2-year flood shall be provided. Low-flow channel requirements do not apply to swales designed in accordance with the UDFCD Manual.
 - (c) Maximum velocities are 5 fps for erosive soils and 7 fps for non-erosive soils.
 - (d) The centerline radius shall be a minimum of 2 times the 100-year flood topwidth.
 - (e) Bank slopes a minimum of 4:1 (horizontal to vertical) are desirable; steeper slopes require review and approval. Riprap bank protection is required for bank slopes steeper than 4:1 and to stabilize channels along the outside of bends. Riprap bank protection shall consist of soil riprap, buried with 6 inches of topsoil and revegetated. Riprap bank protection shall extend to the depth of the 2-year flood, or as approved by the City Engineer.
 - (f) A 15 foot maintenance access shall be provided along one side, adjacent to the top. Maintenance access requirements do not apply to swales designed in accordance with the UDFCD Manual.
3. Detention
- (a) Detention of stormwater shall be based on the more restrictive of: 1) no increases in peak discharge rates; 2) 100-year post-project peak rate no greater than the 50-year pre-project peak rate; 3) the downstream conveyance capacity of a project; or 4) as provided for in Section 3.2.3.a.3(a). Drainage facilities shall be designed to, at a minimum, not adversely impact downstream properties. Proposals to increase downstream conveyance capacity of an area may be considered in-lieu of over-detention on a project, with justification.
 - (b) Drainage planning shall not include the use of right-of-way or road embankments as detention storage areas unless approved by the City Engineer.
 - (c) Drainage planning and design shall provide for stormwater detention based on a design storm up to a 100-Year frequency. The design shall maintain post-development runoff rates to pre-development rates for return periods up

to the 50-year frequency. The 100-year post-development rate shall be held to the 50-year pre-development rate, or as provided for in Section 3.2.3.a.3(a).

- (d) The 10-year peak discharge and volume for infill or re-development project sites of 40,001 sf to 75,000 sf shall be based on the following equations:

$$Q_{10} = \text{Area} * 0.23$$

$$\text{Volume}_{10} = \text{Area} * [(0.95 * I - 1.90) / 1000]$$

where

Area is the project area, in acres

I is the project imperviousness, in percent

Q₁₀ is the allowable 10-year peak release rate, in cfs

Volume₁₀ is the 10-year detention volume, in acre-feet

- (e) A waiver for any detention storage requirements shall include all information necessary to substantiate the detention waiver request.
- (f) Minimum longitudinal slopes are 0.5 percent for concrete and 2 percent for grass. Minimum cross slope is 2 percent. Detention facilities designed with underdrains may reduce the longitudinal and cross slopes to 1 percent.
- (g) Outlet structures shall be functional for controlling the design release rates, provided with oversized safety/debris grates to reduce the potential for debris plugging, to promote ease of maintenance, and designed with favorable aesthetics. Grate sizing shall be in accordance with the UDFCD Manual.
- (h) Embankments shall be no steeper than 4:1 below the 100-year water surface elevation and no steeper than 3:1 above the 100-year water surface elevation. Embankment top width shall be 40 percent of the maximum dam height plus 4 feet, consistent across the entire dam. Earthen slopes shall be covered with 6 inches of topsoil and vegetated.
- (i) Emergency spillways shall be included in the design planning for detention facilities. The emergency overflow spillway shall be sized to convey the 100-year inflow peak. Spillway design velocities exceeding 5 fps shall require buried soil riprap.
- (j) A 15 foot maintenance access with an 8 foot all weather surface shall be provided as needed to

assure access to all pond components.

- (k) Retaining walls within ponds are generally discouraged.
- (l) Two signs, with a minimum area of 3 sf shall be provided. The signs shall be fabricated using red lettering on a white background with the following message:

WARNING

THIS AREA IS A STORMWATER FACILITY
AND IS SUBJECT TO PERIODIC FLOODING

- (m) Parking lot detention criteria include:
 - (1) The maximum allowable design depth above pavement surfaces is 3 inches for the water quality volume, and 9 inches for the 100-year flood.
 - (2) All parking lot detention areas shall have a minimum of two signs posted identifying the detention pond area. The signs shall have a minimum area of 1.5 sf and contain the following message:

WARNING

THIS AREA IS A DETENTION POND AND
IS SUBJECT TO PERIODIC FLOODING
TO A DEPTH OF 9 INCHES OR MORE

- (n) Detention certification is required prior to occupancy, and includes at a minimum:
 - (1) The volume at the design elevation;
 - (2) Size and elevations of the inflow and outflow structures;
 - (3) Spillway and top of dam elevations;
 - (4) Size and elevations of other structures, if applicable; and
 - (5) Embankment compaction meets or exceeds the requirements of Section 2210 of the City of Cheyenne Construction Specifications.

4. Water Quality

- (a) Construction projects meeting any of the following criteria are required to submit for review and approval 1 copy (signed) of the applicable Construction Activity WyPDES Permit and 1 copy of the SWPPP in conjunction with the grading permit application pursuant to Title 15 of City Code:
 - (1) Any project required to submit site construction plans to the City for review and approval, excluding building permit plans;
 - (2) Any project that disturbs 1.0 acre or more;

- (3) Installation or repair of utility lines in excess of 1000 linear feet (outside of the City Right-of-Way);
 - (4) Installation of utilities for a new development exceeding one single-family residence and appurtenant structures, prior to the start of overlot clearing or grading;
 - (5) Any clearing, grubbing, grading or filling operations located within 100 feet of a major drainageway or designated flood hazard area;
 - (6) Fill or excavation of 50 or more cubic yards of material, not related to building of a detached single family residential unit;
 - (7) Any building demolition project; or
 - (8) Any project that the City Engineer determines to have a potential impact to the health, safety and welfare of people or the environment.
- (b) Post-construction BMPs are required to treat a minimum of the WQCV as defined in the UDFCD Manual. The WQCV shall be added to the detention volumes up to the 50-year, and may be incorporated within the 100-year detention volume.
 - (c) Reducing Directly Connected Impervious Area (DCIA) is required. At least 20 percent of the upstream impervious area shall be disconnected and drain through a receiving pervious area comprised of at least 10 percent of the upstream disconnected impervious area. The receiving pervious area shall consist of some combination of grass buffers, swales or porous pavement, designed in accordance with the UDFCD Manual.
 - (d) Exemptions from Post-Construction BMP Requirements may be granted for: 1) Single-family residential lots with a disturbed area less than 0.5 acres, not part of a larger subdivision; 2) Projects with a total imperviousness less than 10 percent for any given acre; 3) Roadway improvement projects that add less than 1.0 acre of new pavement; 4) Subwatershed areas less than 0.5 acre draining off a site; or 5) Other projects determined by the City to have negligible effect on stormwater quality.

5. Roads

- (a) General. New culverts shall not impound runoff to cause inundation of surrounding properties

unless associated with a designed stormwater detention facility. Crossings in floodplains shall meet the City Floodplain and Surface Water Management Regulations and FEMA National Flood Insurance Program requirements. The major storm shall be contained within the public right-of-way or easements.

(b) Urban

(1) Local Street Storm Sewer/Street Networks:
Minor Storm – No curb overtopping. Maximum depth of 6” in cross pans.

Major Storm – Maximum depth 12” above gutter flowline.

(2) Collector/Minor Arterial Street Storm Sewer/Street Networks:

Minor Storm – No curb overtopping and one 10 foot interior drive lane clear of spread. Maximum depth of 6” in cross pans, where allowed.

Major Storm – Maximum depth 12” above gutter flowline. Maximum depth of 12” at cross street intersections.

(3) Major Arterial Street Storm Sewer/Street Networks:

Minor Storm – No curb overtopping and two 10 foot interior drive lanes clear of spread. No cross street flows allowed.

Major Storm – Maximum depth 12” above gutter flowline. Maximum depth of 6” at cross street intersections.

(c) Rural

(1) Public Roads: Culverts - Minor Storm;
Roadside ditches - Major Storm.

(2) Drainage Channels or Swales (Major Storm within easement).

6. Easements. Permanent drainage easements shall be provided in any scenario whereby drainage from one property must cross another property prior to entering the public drainage system. Permanent drainage easements shall also be provided in all areas traversed by a creek, channel, public storm sewer or storage area. Easements shall be accessible from the public right-of-way and shall be useable for maintenance vehicles. Drainage easements shall be shown in the drainage impact study, and platted, dedicated, established by affidavit or otherwise recorded prior to the issuance of a Certificate of Occupancy. Drainage easements shall be kept clear

of impediments to the flow.

(a) Storm Sewers

Table 3: Minimum Acceptable Storm Sewer Easement Widths	
Pipe Size	Easement Width
Less than 36-inch diameter	25 feet *
36-inch diameter and larger	30 feet *

* Or as required to meet Occupational Safety and Health Administration (OSHA) and construction requirements

- (1) When relatively large diameter pipes are proposed or when design depths are excessive, greater easement widths will be required, as determined by the City Engineer.
- (2) The pipe shall be constructed at one-third of the easement width to allow for stockpiling of material on one side of the storm sewer trench.
- (3) Storm sewer easements should be designed to convey above ground flows in the event the storm sewer or inlet becomes clogged or full. It is therefore necessary to limit uses within the easement to ensure that surface conveyance redundancy and maintenance access is not impaired. Minor landscaping, such as rock or shrubs, may be appropriate where it can be demonstrated that the function of the easement is not compromised by the presence of the materials. Pavement over a storm sewer easement is allowable, providing the property owner assumes responsibility for replacement in the event it is necessary to remove it to access the pipe. Improvements that are not allowed on storm sewer easements include structures of any kind, retaining walls, permanent fencing, trees and other objects if determined by the City to be inconsistent with the design intent of the easement or costly to replace. Surface treatments on drainage easements shall be shown in the drainage impact study, and accepted by the City.
- (4) Storm sewer easements shall not be required for pipes collecting and transporting water solely within a single parcel.

(b) Channels

- (1) To ensure that drainageways and the associated conveyances are adequately preserved and properly maintained, all drainageways that convey flows from other properties should be placed on tracts of land owned by a public entity (e.g. special district, City, or other regional agency), by a homeowner's association, or by approval by the City Engineer. Easements are allowed for drainage swales between individual lots.
- (2) Required easement widths for natural drainageways need to provide for conveyance of design flow rates, required freeboard, and access for maintenance. Any banks allowed to remain in place at a slope steeper than 4 to 1 shall have the easement line set back from the top of the bank to allow for some lateral movement or future grading improvements to the bank. The easement line shall be no closer than the intersection of a 4 to 1 line extending from the toe of the slope to the proposed grade at the top of the bank, plus an additional width of 15 feet for an access bench, if access is not feasible within the floodplain.
- (c) Ponds. The minimum easement requirements for detention basins are as required to contain storage and WQCV including freeboard, associated facilities, and adequate maintenance access around the perimeter.

c. **Special Flood Hazards.** The drainage requirements and regulations for the development of land located in and adjacent to permanent or periodic streams subject to flooding, and identified and designated as potential flood areas by FEMA, or the City's Special Flood Hazard Area map, shall also be in accordance with Chapter 13.24 of the Cheyenne City Code – FLOODPLAIN AND SURFACE WATER MANAGEMENT.

d. **Alternative Compliance Measures.** The developer may propose and the City Engineer may approve alternative compliance measures. Alternative compliance measures include new technologies, overall system improvements, innovative procedures, and new materials. It shall be the developer's responsibility to demonstrate that alternative compliance measures meet these criteria and meet the Purposes of this Sub-article 3.2. The review of alternative compliance measures shall be based upon:

1. Whether the alternative compliance proposed is part of a plan to improve stormwater management on a larger scale beyond the immediate site.
 2. The extent that alternative site design strategies construct all or a portion of the larger-scale improvements in the chain of treatment and comply with this Sub-article 3.2 standards to the fullest extent possible.
 3. Data and calculations, studies, industry publications, or additional evidence such as successful use in other jurisdictions to demonstrate any of these criteria.
- e. **Exceptions.** Where, due to the physical limitations of the project site, topography or ground slopes, soil or rock conditions or other physical or context limitations, meeting the mitigation Standards and Design Criteria is not feasible, the City Engineer may grant exceptions to the standards. Review of requested exceptions shall be based upon:
1. Whether the situation giving rise to the requested exception is due to the developer's actions.
 2. Whether the alternative compliance proposed will cause temporary or permanent harm to offsite properties.
 3. Whether the requested exception complies with this Sub-article 3.2 to the fullest extent possible.

The City may condition any exception in any way that ensures the above criteria are met, including participation in the funding of any off-site improvements, the formation of a local improvement district, or other stormwater master planning strategies and facilities that ensure the Purposes of this Sub-article 3.2 are met.

3.2.4 Study Reports

The primary purpose of a drainage impact study is to identify drainage related issues and outline a plan to mitigate all potential negative impacts resulting from the proposed development action. Developers and design representatives are encouraged to contact the City Engineer early in the design process to discuss drainage related issues and potential mitigation alternatives.

Final drainage reports will be valid for two years from the date of City Engineer's approval. If construction drawings have not been developed and accepted by the City Engineer within two years, the final drainage report must be submitted for re-

acceptance. Review and re-acceptance will be based upon any new criteria or standards adopted since the drainage report was initially accepted.

a. General Requirements.

1. A cover sheet with project name and location, type of report (Conceptual, Preliminary, or Final), name of firm or agency preparing the report, date of the report, table of contents, and page numbers.
2. A certification sheet with the following statement, and appropriate signatures:

"I hereby attest that this report for the (Conceptual, Preliminary or Final) drainage design of (Name of Development) was prepared by me, or under my direct supervision, in accordance with the provisions of City of Cheyenne Unified Development Code for the responsible parties thereof. I understand that the City of Cheyenne does not and shall not assume liability for drainage facilities designed by others."

Registered Professional Engineer

State of Wyoming No. _____ (Affic Seal)

3. A vicinity map (if not included with a plat map) along with applicable addresses, Township, Range, and Sections and Quarter (1/4) Sections. Identify adjacent existing and proposed streets and subdivision names.
4. Discussion of the major drainage basin and subbasins, if applicable.
5. Discussion of the existing property and adjacent rights-of-way impacted by the project and predevelopment drainage characteristics. This shall include identifying current floodplain and flood hazard areas.
6. Discussion of any upstream properties and existing upstream drainage characteristics.
7. Discussion of existing conveyance downstream of project to nearest major drainageway. This shall include identifying potential downstream conveyance and capacity issues.
8. Discussion of proposed stormwater management plan to mitigate post-development drainage impacts. This shall include outlining a plan to maintain conveyance from upstream projects and proposed stormwater detention systems on the site.

9. Other items of discussion may be included to provide additional background information or substantiate the proposed drainage plan.
10. For projects anticipated to be sold off for future development by others, the conceptual drainage report shall outline a conceptual drainage plan (anticipated surface and storm drain conveyances along with detention requirements) for the entire development. This shall include accounting for all initially anticipated improvements.
11. An overall drainage plan map is required for projects larger than 2 acres or at the request of the City Engineer. Drainage map(s) shall be a minimum of 11" x 17" in size with a scale of 1"=20' to 1"=100' as required to show sufficient detail. The overall drainage plan map(s) shall include the following:
 - (a) Outline of upstream area including existing and proposed inflow points;
 - (b) Outline of overall project area, including property lines, street rights-of-way, and all easements;
 - (c) Outline of downstream conveyance path to nearest major drainageway;
 - (d) Outline of proposed drainage features;
 - (e) Existing and proposed drainage patterns. Contours shall be at 2 foot intervals unless otherwise approved by the City Engineer, with proposed elevations sufficient to analyze drainage patterns extending 100 feet beyond property limits. Contour elevations shall be referenced to USGS vertical datum where contours are taken from USGS maps, or referenced to the most current aerial mapping of the City and County. Locate and label all drainage basins, sub-basins and floodplains;
 - (f) Proposed outfall location of point discharges and ultimate receiving drainageway.
12. References to master plans or other relevant local studies shall be included in the conceptual report narrative.
13. For hydrology computations, include and clearly identify the following, if applicable:
 - (a) Any computer modeling software and version used with an analysis;
 - (b) Precipitation/runoff methodology/model used for analysis on the project (i.e. Rational Method, Kinematic Wave, SCS Unit Hydrograph, EPA SWMM, CUHP, etc.). Rational Method may be used for tributary acres of 30 acres or less;

- (c) Rainfall data or design storm source references;
 - (d) Rainfall loss method (i.e. runoff coefficient(s), curve number, Horton, Green-Ampt, etc.) and input parameters;
 - (e) All other input parameters and calculations (area, timing, connectivity, rating curves, etc.);
 - (f) Summarized results with complete computer modeling (hard copy and digital).
14. For hydraulic computations, include and clearly identify the following, if applicable:
- (a) Any computer modeling software and version used with an analysis;
 - (b) Parameters (materials, lengths, size, roughness, rating curves, etc.);
 - (c) Summarized results with complete computer modeling (hard copy and digital).
15. Geotechnical investigations and reports are required.
- b. **Conceptual Plan.** Conceptual drainage reports are primarily for development projects which are being developed before or during a preliminary plat or preliminary development plan stage and anticipated to evolve into final drainage plans with future development action submittals. The intent of the Conceptual Drainage Report is to outline drainage planning for the project in narrative and visual format for review by the City Engineer prior to preparing more detailed studies and designs. The conceptual report shall include all the above general requirements.
- c. **Preliminary Plan.** Preliminary drainage reports are primarily for projects which are being developed before or during a final plat or final development plan stage. The Preliminary Drainage Report is an intermediate drainage planning report to provide sufficient detail required for projects anticipated to evolve into future construction plans or site plans. The intent of the Preliminary Drainage Report is to finalize drainage planning for the project in narrative, visual, and computational format for review by the City Engineer. For large development or multi-stage, multi-lot projects, the preliminary drainage plan shall serve as a reference document for future drainage planning when improvements are not fully completed by the developer requesting the development action.

The Preliminary Drainage Report shall contain the following information:

1. All the above general requirements as provided in Subsection a., of this Section.
2. Overall drainage map and plans with increased detail.
3. Detailed runoff computations from the pre-development area (on-site, upstream).
4. Detailed computations on existing downstream conveyance systems to be utilized with the project.
5. Preliminary computations on proposed street and drainage conveyance systems.
6. Preliminary computations on proposed detention systems and outlet controls, including time of total evacuation. Volume computations shall include a detention systems storage volume in cubic feet or acre-feet and the proposed volume in terms of inches of storage for gross tributary area. For areas being platted specific for detention, the preliminary design of the detention facility shall be included showing preliminary design contours.
7. Computations and computer modeling results to substantiate findings and recommendations.
8. For projects being approved without final details such as a Final Plat, a letter shall be submitted with the drainage report which includes the following:

"<Name of Developer/Property Owner> hereby acknowledges that the stormwater management planning outlined in <drainage report title & date> was prepared for <development action> without final design details or construction plans. I understand that acknowledgement of receipt of this drainage plan by the City of Cheyenne does not constitute any formal endorsement of a final drainage plan until final designs and details can be reviewed and approved. I also acknowledge that future final drainage design reports and details shall be required by the City prior to construction or acceptance of drainage facilities for the < subdivision or project name>."

<Developer/Property Owner>

Authorized Agent

Date

- d. **Final Plan.** Final drainage reports are primarily for projects in the Construction Plan or Site Plan review state. The intent of the Final Drainage Report is to outline final drainage design details for review by the City Engineer. The Final Drainage Report shall include all information to

substantiate the final design. If no substantial changes are required to a Preliminary Drainage Report, the Final Drainage Report may be submitted as an amendment to the Preliminary Drainage Report. Final Drainage Reports shall be submitted to the City Engineer’s Office in digital format.

The Final Drainage Report shall contain the following information:

1. All requirements of the Preliminary Drainage Report, with the exception that final design computations shall be included for all proposed drainage facilities.
2. Detailed Drainage, Grading and Site Plans including finalized:
 - (a) Proposed storm sewer improvements locations and all details;
 - (b) Proposed channel improvements with typical cross-sections and major flow limits;
 - (c) Proposed culvert locations and all details;
 - (d) Permanent drainage easements.
3. Comparison tables and graphs of pre-development and post-development runoff rates for major and minor storms events.
4. Detention area(s) summary table(s) and curve(s) showing the following:
 - (a) Stage vs. Area;
 - (b) Stage vs. Volume;
 - (c) Stage vs. Discharge (or outflow).
5. The report shall include the following certification:

"I, <Name of Developer/Property Owner> hereby certify that the drainage facilities <name of development> shall be constructed according to the design presented in this report. I understand that the City of Cheyenne does not and will not assume liability for the drainage facilities designed and certified by my engineer. I understand that the City of Cheyenne reviews drainage plans but cannot, on behalf of <Name of Developer/Property Owner>, guarantee that final drainage design review will absolve <Name of Developer/Property Owner> or their successors or assigns, of future liability for improper design. I further understand that approval of the <Final Plat or Final Site Plan> does not imply approval of my engineer’s drainage design.

<Developer/Property Owner>

Authorized Agent

Date

3.2.5 Final Acceptance of Drainage Improvements

A request for final acceptance of drainage improvements shall be made to the City Engineer. Final acceptance requires the submittal of construction drawings clearly labeled as "Record Drawings", "As-built Drawings", or "As-Constructed Drawings". The drawings shall be made by a Wyoming Licensed Professional Engineer or Professional Land Surveyor and include the following notation:

"I hereby attest that the installed drainage facilities as shown on <construction plan name, date> have been constructed in accordance with the approved drainage design for the <name of development>. The stormwater drainage facilities installed at this location conform to the approved design plans. Stormwater detention facilities constructed for this project facility meet or exceed storage volumes requirements outlined in the <Final Drainage Report> dated <date of final report> by <firm preparing Final Drainage Report>. Detention pond volumes for <name of detention facility or number> is <volume>. Deviations from the approved plan include <outline list of changes >."

Registered Professional Engineer/Land Surveyor
State of Wyoming No. _____ (Affix Seal)
<Date>

3.2.6 Maintenance

- a. **Private Maintenance.** All components of the drainage system constructed on private property shall be maintained by the property owner or a representative of the owner. Maintenance responsibilities shall be defined on final plats and site/construction plans. Such maintenance shall include periodic cleaning, weed and grass cutting, repairs to pipe and underground structures and all else which is reasonably expected of a publicly owned and operated utility system.

In the event the owner fails to inspect, report, or properly

maintain the system within 30 days after written notice by the City to the owner of such deficiencies, the City may enter upon the property and take whatever steps it deems necessary to maintain or repair the system and bill the owner for such expense. However, if the owner's failure to properly maintain the system could cause damage to property, loss of life or a violation of a NPDES MS4 Permit, the City may take immediate action, without notice to the owner, to maintain or repair the Facilities.

It is expressly understood and agreed that the City is under no obligation to maintain or repair the system.

- b. **Public Maintenance.** The City shall maintain those components of drainage systems that are constructed within the City right-of-way or on land owned by the City. The City shall maintain components of drainage facilities located on private property in areas within drainage easements only when said systems are constructed to manage stormwater for a broad area that extends beyond the confines of the property where the facility is located and only when said systems have been formally accepted for public maintenance pursuant to a written instrument executed by the Mayor or other authorized official of the City.

3.2.7 Grading and Erosion Control Permit [Reserved]

3.3 [RESERVED]

ARTICLE 4 SUBDIVISION REGULATIONS

4

Article 4, Subdivision Regulations provides standards for coordinating development across different areas and over time. It addresses development patterns and includes planning, design, and engineering standards for systems that coordinate development across large areas, including open space, transportation, and utilities. It is most useful to anyone considering dividing land and public officials that review development applications in relation to long-range plans and impacts.

UNIFIED DEVELOPMENT CODE

ARTICLE 4 SUBDIVISION REGULATIONS

- 4.1 General Provisions
- 4.2 Community Facilities and Fees
- 4.3 Transportation Networks and Street Designs
- 4.4 Open Space Systems
- 4.5 Required Improvements and Engineering Specifications
- 4.6 Public Safety Fees

4.1 General Provisions

- 4.1.1 Purposes
- 4.1.2 Applicability
- 4.1.3 Subdivision Design Elements
- 4.1.4 Site Considerations
- 4.1.5 Applicant Responsibilities

4.1.1 Purposes

This Article contains standards to control the subdivision of land within the planning jurisdiction of the City, and in addition to the general purposes of these regulations, the standards in this Article have the following specific purposes. To:

- a. Ensure that all development blocks and lots are served by necessary infrastructure services, including utilities, transportation, storm drainage, public safety, and community facilities, but recognize that necessary service levels may differ based on the context, character, and intensity of development.
- b. Emphasize subdivision review as the initial and principal opportunity to consider the long-range implications and opportunities of development.
- c. Establish standards for different contexts which support and reinforce different development patterns called for in the Comprehensive Plan.
- d. Promote good civic design and arrangement that improves the layout, form, and relationship between buildings, sites, lots, open spaces, and rights-of-way through context-based planning and design solutions.
- e. Evaluate development applications as segments of

- the entire community allowing for public and private investments to be coordinated across areas and over time.
- f. Prevent premature divisions of land that by its permanence may negatively impact long-term development patterns or that lack appropriate infrastructure, both of which may result in inefficient use of land and resources that would later require excessive expenditures of public funds to correct.
- g. Implement the Comprehensive Plan and any other official plan, program or policy developed under the guidance of the Comprehensive Plan by incorporating broad planning and community design standards when the division of land occurs.
- h. Encourage more efficient development by analyzing adjacencies and identifying on- and off-site opportunities for infrastructure, facility, or site design systems and that operate independent of lot and subdivision boundaries.

4.1.2 Applicability

The requirements and standards of this article shall apply to all new divisions of land and development within the jurisdiction of the City.

4.1.3 Subdivision Design Elements

The subdivision standards require that all divisions of land be considered in a comprehensive manner, integrating different core community design elements within the same subdivision and linking these elements into efficient systems across many adjacent subdivisions. This Article establishes standards for the following basic elements that are necessary to develop complete and integrated communities:

- a. **Transportation Networks and Street Designs.** The network and design of streets to support the proposed division of land, including the relationship to existing and planned streets on adjacent property and the relationship of public streetscapes to adjacent lots and buildings.
- b. **Open Space Systems.** A system of various types of open spaces that determine the community character and meet aesthetic, recreational, and ecological needs for the proposed division of land.
- c. **Blocks and Lots.** The arrangement of the land division within the network of streets and system of open spaces into an orderly pattern with necessary access and services.

ARTICLE 4

SUBDIVISION REGULATIONS

4.2 COMMUNITY FACILITIES AND FEES

- d. **Public and Community Facilities.** Areas of land that support development by meeting broad public and community needs, and which may be identified and anticipated in other public or community plans.
- e. **Required Improvements.** A system of utilities, storm drainage, and other service facilities necessary to serve the blocks and lots platted within the subdivision.

4.1.4 Site Considerations

In interpreting and applying these standards, the following site considerations shall apply:

- a. Steep or unstable land and areas having inadequate drainage shall not be subdivided or developed into building lots unless the Applicant makes adequate provisions, satisfactory to the City Engineer, to prevent endangering life, health, or other property.
- b. Subdivision design shall be in accordance with the provisions of the Storm Water Management Manual and the Floodplain Management Regulations.

4.1.5 Applicant Responsibilities

- a. The owner or agent of the owner of any parcel of land located in a proposed plat shall not transfer or sell any parcel within the plat prior to the approval of the plat by City and recording of the plat with the Laramie County Clerk.
- b. The applicant shall be responsible for obtaining and/or providing the necessary professional services to fulfill the following requirements:
 - 1. Preparation and design of the plat map and the design/construction plans and specifications for all public improvements to serve the subdivision/development;
 - 2. Preparation of all reports necessary to support the plat;
 - 3. Submission of the plat map with supporting documents, fees and the design/construction plans and specifications to the appropriate governmental agency, to include submittal to the Department of Environmental Quality (DEQ);
 - 4. Coordination of the plat map, supporting documents, design/construction plans and specifications in accordance with any requirements set forth in these Regulations;
 - 5. Compliance with conditions imposed by the City

- Council;
- 6. Installation of all necessary public and private improvements;
- 7. Assurance by bond, certified check, development agreement, or other written legal obligation approved by the City that all improvements will be constructed; and
- 8. Recording of the original plat map and the required copies and payment of the fee to the Ex-Officio Recorder for Laramie County.

4.2 Community Facilities and Fees

- 4.2.1 Intent
- 4.2.2 Dedication of Land
- 4.2.3 Reservation of Land
- 4.2.4 Credits and Reimbursement
- 4.2.5 Park Fees

4.2.1 Intent

It is the Intent of this Section to:

- a. Anticipate and evaluate the incremental and long-term impact of development on broader public and community facility needs.
- c. Identify opportunities to integrate plans for public and community facilities into the planning and design of proposed land divisions.
- d. Consider the location of public and community facilities with initial planning considerations for streets, open spaces, blocks, and lots, so that needed facilities are located conveniently in neighborhoods and districts and serve as focal points for the community.
- e. Provide the opportunity to negotiate a fair and equitable price for land needed to develop public or community facilities, or alternatively to provide an incentive for land owners to dedicate land for needed facilities where the lack of facilities may otherwise constrain potential future development.
- f. Ensure that the most appropriate locations of public and community facilities are identified and considered prior to the premature commitment of these areas to conflicting development patterns.
- g. Collect fees for the roughly proportional and reasonably related impact of development on Community Facilities.

ARTICLE 4

SUBDIVISION REGULATIONS

4.2 COMMUNITY FACILITIES AND FEES

4.2.2 Dedication of Land

The Planning Commission or City Council may request the dedication of land to the City or other government entity with jurisdiction over public and community facilities, for parks, open space, public safety facilities, or similar public or community facilities.

- a. The request for dedication shall be based on an official master plan of the entity having jurisdiction over the facility identifying the general location and extent of the facility, or some other documented need for the facility that is available for public review.
- b. The dedication shall be included on the preliminary plat or a condition of approval of the preliminary plat at the discretion of the applicant.
- c. Acceptance of the dedication shall be agreed to in writing by the entity having jurisdiction over the site or facility prior to approval of the final plat. Upon dedication the applicant may be eligible for credits towards open space requirements and reimbursement of community facility fees according to Section 4.2.5.

4.2.3 Reservation of Land

The Planning Commission or City Council may require the reservation of land for public or community facilities, parks, open space, public safety facilities, culture facilities, school sites, or similar public or community facilities. The reservation shall be for a time period of no more than 1 year, unless otherwise agreed to by the applicant, to permit acquisition of the land by the appropriate public entity.

- a. The reservation by the Planning Commission or City Council shall:
 1. Be based on community facility needs that may serve an impact beyond that caused by the proposed development, and which are not otherwise met through Dedication as provided in 4.2.2 or Community Facility Fees provided in this Section;
 2. Be based on an official master plan approved by the entity with jurisdiction over the public facility identifying the general location and extent of the facility, or some other documented need for the facility that is available for public review; and
 3. Be accompanied by a conceptual plan and program provided by the entity with jurisdiction over the improvement, demonstrating how the entity's facility

needs relate to the site. The conceptual plan shall include information reasonably necessary for the applicant to plan for development around the reserved site and to prepare contingency plans in the event the site is not acquired by the public entity. Development plans for the unreserved property shall not adversely affect the potential use of the reserved property for the designated public or community facility.

- b. At the Planning Commission's or City Council's discretion, the reservation may be part of the preliminary plat approval:
 1. The reservation period begins upon approval of the preliminary plat;
 2. The City or other public entity with jurisdiction over the public facility may commence negotiations for the site, and negotiation shall begin within 60 days of the preliminary plat approval;
 3. In the event that the property is not acquired for a public facility within the reservation period the applicant may agree to extend the reservation to continue negotiations;
 4. The entity with jurisdiction over the facility or site may terminate negotiations at any point during the reservation by a written statement submitted to the applicant and Director;
 5. During the reservation period or in association with the preliminary plat, the applicant may submit a contingency preliminary plat for the portion of the property subject to the reservation. A contingency plat shall include all of the information of a preliminary plat for the reserved property, and can serve as the preliminary plat if the negotiation is terminated or unsuccessful.
- c. The applicant may submit a final plat according to the standards and procedures in Article 2. A final plat for any portion of the site that was reserved may only be approved if there was a contingency plat approved as provided in b.5 above. Any final plat for a reserved portion may be conditionally approved, and shall not be recorded until the 1-year reservation period has expired or negotiations have terminated. Otherwise any reserved portion not acquired within 1 year will require a preliminary and final plat according to the standards and procedures in Article 2.
- d. Upon acquisition of a reserved site, the applicant may be eligible for credits towards open space requirements and

community facility fees according to Section 4.2.5 as part of the negotiations. In order for any credit to be applied to portions of the unreserved area, the acquisition shall be agreed to in writing by the entity having jurisdiction over the site or facility prior to approval of the final plat.

4.2.4 Credits and Reimbursement

- a. **Open Space Credit.** Any land dedicated to and accepted by a public entity through the dedication or reservation procedures in Sections 4.2.2 and 4.2.3 may be a direct credit to the area of open space required for Open Space Systems in Section 4.4. As part of the negotiation for the dedication, the City may elect to authorize a greater credit than the area actually acquired or dedicated, based on the community need for the facility and public benefit to lands outside of the proposed development.
- b. **Fee Reimbursements.** Where any land is dedicated, Park Fees in Section 4.2.5 will be reimbursed in accordance with a development agreement or other mutually agreeable mechanism. The following criteria and Tables 4-3 and 4-4 are recommended for inclusion in a development agreement:
 - 1. **Land Acquisition Fee.** The Land Acquisition Fee may be reimbursed for any land that is dedicated to the City for parks purposes and which meets the Parks and Recreation Master Plan criteria for location and area.
 - 2. **Infrastructure Fee.** The Infrastructure Fee may be reimbursed if the land dedicated includes the base infrastructure improvements in Table 4-3.
 - 3. **Enhancement Fee.** The Enhancement Fee may be reimbursed if the land dedicated includes the base infrastructure in Table 4-3 and the park enhancements in Table 4-4.
- c. **Park Approval and Acceptance.** In order to receive the open space credits or fee reimbursement offered by dedication of parks and recreation facilities, the applicant shall meet the following criteria through the platting process:
 - 1. A park, trail or open space plan meeting the Parks and Recreation Department standards shall be submitted to the Parks and Recreation Department as part of a pre-application meeting prior to approval of the preliminary plat.

- 2. A final design plan that meets the Parks and Recreation Department standards shall be submitted by the applicant, approved in writing by the Parks and Recreation Department, and made a condition of approval of the final plat.
- 3. The applicant shall pay the fee at the time due as required by section 4.2.5 but shall be reimbursed the applicable fee upon the City's inspection and acceptance of the constructed park facility. As an alternative to paying the fee the applicant may issue a performance bond for 125% of the estimated cost of the improvements proposed.

4.2.5 Park Fees

- a. **Establishment.** Platting in the City requires the assessment of park development fees. The fees are considered an impact fee for development. The assessment of fees is made in association with an approved Final Plat. Fees listed apply to either first time plats or replats, but fees shall not be duplicated for the same parcel. A development agreement or other mechanism may be used to clarify reimbursement of fees.
- b. **Plat Fee Calculation.** The required fee shall be calculated as follows for lands being platted, replatted or any land being annexed that was platted in the County after adoption of these regulations:

TABLE 4-1: PARK FEES	
<i>Land Acquisition Fee*</i>	<ul style="list-style-type: none"> ▪ \$ 350.00 per acre (pro-rated to the nearest one-tenth of an acre) ▪ Minimum fee \$125.00
<i>Infrastructure Fee*</i>	<ul style="list-style-type: none"> ▪ \$ 350.00 per acre (pro-rated to the nearest one-tenth of an acre) ▪ Minimum fee \$125.00
<i>Enhancement Fee, Residential**</i>	<ul style="list-style-type: none"> ▪ \$400.00 per dwelling unit***
<i>Enhancement Fee, Non-residential**</i>	<ul style="list-style-type: none"> ▪ \$ 1,100.00 per acre (pro-rated to the nearest one-tenth of an acre) ▪ Minimum fee \$250.00

* To be paid into the Park Acquisition and Infrastructure (PAI), to be used for park land acquisition and/or base infrastructure supporting the service area.

** To be paid into the Park Enhancement Account (PEA), to be used for enhancements to new or existing parks supporting the service area.

*** For the purposes of this section dwelling unit shall be defined by the

applicable adopted version of the International Building Code and International Residential Code, and exclude hospitals and nursing homes.

c. **Exemptions.** The following lands are exempt from the Park Fees in Table 4-1:

1. Lands platted for governmental use (including schools, parks, greenways, offices, etc.)
2. Lands dedicated for public rights-of-way (including streets, roads, alleys, trails, etc.)
3. Lands dedicated for public utility (including drainage facilities, channels, detention areas, etc.)
4. Lands platted as un-developable parcels for the purposes of meeting any Civic Open Space requirements in Section 4.4.
5. Property that remains zoned AG, AR, and RR shall not be assessed a fee until rezoned.
6. Where land is being replatted, it shall be exempt if:
 - (a) The replat consists only of reconfiguring or eliminating interior lot lines with no additional land or building area added to the development;
 - (b) The replat results in no additional dwelling units, residential units, non-residential units or lots, and therefore causes no greater impact on public park facilities than the original plat; and
 - (c) The replat results in no change in zoning, density, or intensity of use than the original plat.
7. Lands platted as remainder lot(s) created in accordance with Chapter 2.1 of this code.

All other replatted land shall be subject to the fees in Table 4-1, except any fee previously paid at the initial plat may be credited to the amount required by Table 4-1.

d. **Limitations of Fee Use.** The Land Acquisition Fee, Infrastructure Fee, and Enhancement Fee shall not be used for the following:

1. Routine maintenance of public parks.
2. Overhead or general fund purposes.

e. **Payment Schedule.** Fees shall be payable according to the following schedules.

TABLE 4-2: PAYMENT SCHEDULES

<i>Land Acquisition Fee;</i> <i>Infrastructure Fee; and</i>	Payable in full at the time of the signing of the plat if the total fee is less than \$5,000.00. If the total fee is greater than \$5,000.00, 10% of the total fee shall be paid at the time of the signing of the plat along with a contractual agreement between the City and the Applicant outlining a payment schedule for the remaining balance. The contractual agreement shall be executed with the plat signing.
<i>Enhancement Fee</i>	Payable at the issuance of a building permit.

Any land platted after adoption of these regulations but prior to annexation, shall be subject to the applicable Land Acquisition Fee, Infrastructure Fee and Enhancement Fee at the time of annexation or at the issuance of a building permit as provided in Table 4-2.

f. **Public Reporting and Accountability.** The City shall each year report the source and disbursement of the fees as follows:

1. At the third regularly scheduled City Council meeting after the end of each fiscal year, a written report shall be presented to the City Council on the fees with the following information:
 - (a) Source of all fees by person, subdivision/development name and amount collected;
 - (b) Disbursement of any fees to whom and by project or item(s) and the amount of purchase; and
 - (c) Balance in the fee accounts as of June 30th of each year.
2. The Treasurer of the City shall maintain a specific account for all fees independent from all other general fund accounts of the City. This account shall be represented and budgeted in the annual budget reporting of the City.

ARTICLE 4 SUBDIVISION REGULATIONS

4.3 TRANSPORTATION NETWORKS AND STREET DESIGNS

TABLE 4-3: BASE INFRASTRUCTURE FACILITIES

<i>Improvement</i>	<i>Standard</i>
<i>Finished Grade</i>	<ul style="list-style-type: none"> A minimum of 50% of the park site must be graded to a useable and maintainable finished grade, and exhibit an average slope of one to five percent. The useable park space shall be of a shape or configuration to comfortably accommodate a range of passive and active recreational activities, potentially including appropriately sized athletic practice fields. The site must exhibit positive surface drainage throughout in accordance with the City's drainage requirements. The remaining park site area can remain in its original undisturbed condition if it will not pose a negative impact to the new park project or adjacent development.
<i>Turfgrass</i>	<ul style="list-style-type: none"> A high quality turfgrass must be established and provided for areas of the park that are intended to accommodate passive and active recreational activities. The turfgrass areas must constitute a minimum of 50% of the total park site, and coincide with the park land in the one to five percent range of slope. The remaining park site can be covered with a prairie grass mix to achieve a more natural and lower maintenance condition, or maintained in its current undisturbed condition as stated above.
<i>Landscape Irrigation</i>	<ul style="list-style-type: none"> A modern and functional landscape irrigation system shall be provided for the turfgrass areas intended for outdoor passive and active recreational activities.
<i>Water Service</i>	<ul style="list-style-type: none"> The water service provided for the landscape irrigation system must also be capable of serving future park project improvements, including restrooms, drinking fountains, and other amenities requiring potable water.
<i>Sanitary Sewer Service</i>	<ul style="list-style-type: none"> A capped sanitary sewer service lateral shall be provided to one of the park site boundaries as established by the City during the park design process, and shall be suitable for future extension into the park project to support future park improvements.
<i>Electrical Service</i>	<ul style="list-style-type: none"> Electrical service shall be provided to one of the park site boundaries as established by the City during the park design process, and be suitable for future extension into the park project to support future park improvements.

All improvements shall meet these standards and the City of Cheyenne Parks and Recreation Department and Public Works Design and Engineering Standards.

TABLE 4-4: ENHANCED PARK FACILITIES

<i>Improvement</i>	<i>Standard</i>
<i>Parking</i>	<ul style="list-style-type: none"> 3 per acre minimum / 5 per acre maximum. On-street parking is preferred over surface parking lots, and must be counted towards the maximum on streets that allow on-street parking.
<i>Paved Walkways</i>	<ul style="list-style-type: none"> 300 linear feet per acre, exclusive of walkways in ROW. The City may grant exceptions to the interior walkway requirement when park design and walkways are coordinated with walkways in ROW.
<i>Shelter with Paved Surface Underneath</i>	<ul style="list-style-type: none"> 1 per 5 acres (no requirement under 5 acres)
<i>Multi-feature Play Structure - ages 2-5 years</i>	<ul style="list-style-type: none"> 10 activity features per 5 acres (8 minimum, if under 5 acres)
<i>Multi-feature Play Structure - ages 5-12 years</i>	<ul style="list-style-type: none"> 10 activity features per 5 acres (8 minimum, if under 5 acres)
<i>Drinking Fountain</i>	<ul style="list-style-type: none"> 1 per 5 acres (1 minimum)
<i>Bench</i>	<ul style="list-style-type: none"> 1 per acre (2 minimum)
<i>Trash Receptacle</i>	<ul style="list-style-type: none"> 1 per 2 acres (1 minimum)
<i>Shade Trees (2.5" to 3" caliper min.)</i>	<ul style="list-style-type: none"> 10 per acre

All improvements shall meet these standards and the City of Cheyenne Parks and Recreation Department and Public Works Design and Engineering Standards. With the exception of shade trees, all quantities shall be rounded down.

4.3 Transportation Networks and Street Designs

- 4.3.1 Intent
- 4.3.2 Transportation Network Plan
- 4.3.3 Block Size and Connectivity Requirements
- 4.3.4 Street Design Types
- 4.3.5 Intersection Designs
- 4.3.6 Block and Lot Access
- 4.3.7 Access Management for High-volume / High-speed Roadways

4.3.1 Intent

The Intent of this Section is to:

- a. Prioritize planning street networks and the design of street types as an important and substantial civic asset that establishes permanent patterns and the character of the public realm of the City.
- b. Provide for efficient and safe movement and access along all public ways through a variety of modes of transportation, including automobiles, bicycles, pedestrians, and potentially transit.
- c. Coordinate the findings of any required Transportation Impact Study or Transportation Impact Assessment with the development and division of land.
- d. Complement regional transportation systems with local networks that support multiple and alternative routes for daily trips, do not overly burden any single roadway, and include logical connections to existing, planned, or potential future streets.
- e. Coordinate available street designs with the appropriate transportation networks and development patterns.
- f. Plan street networks that allow the design of streets to transition along their length to best support anticipated and adjacent land uses and development patterns.
- g. Develop balanced street designs (“complete streets”) for regional and local routes that accommodate all potential users of the street and rights-of-way, so that the interests of a single mode of transportation do not unnecessarily compromise other modes of transportation.

4.3.2 Transportation Network Plan

- a. **General Requirements.** All divisions of land shall include a transportation network plan that shall:

1. Comply with long range transportation plan and the master street plan, and provide a local street network for connections with these plans.
2. Comply with the findings of any Transportation Impact Study or Transportation Impact Assessment conducted for the area or required by the development, particularly incorporating recommended mitigation alternatives.
3. Provide connectivity at the local street level sufficient to meet the goals, policies and principles of the Comprehensive Plan and Transportation Plan.
4. Coordinate with planned land uses within the subdivision, and integrate with existing or planned and anticipated land uses beyond the subdivision.
5. Coordinate with other geographical, topographical and utility constraints.

Applications featuring small parcels or platting within previously developed area shall relate any proposed streets and access points to the surrounding existing transportation network according to these standards.

- b. **Functional Classification.** The functional classification of a street refers to the general function in the overall transportation system and addresses primarily the continuity of the street and the traffic capacity that it is designed for when considered in context of the entire transportation system. Functional classification does not necessarily dictate the cross section design or design on any one segment of the street. A number of different cross sections may be appropriate for a single functional classification depending on the extent of the surrounding transportation network, the planned and anticipated adjacent land uses, and the speeds desired for that particular segment of the street.

Table 4-5 provides planning parameters for the Transportation Network Plan based on the functional classification and the role of the street in the entire street network, including areas beyond the development site. Specific cross sections that may be applicable to segments of streets should be based on existing or planned land uses fronting on the segment and are provided in Section 4.3.4 Street Design Types.

- c. **Private Street Standards.** All roads and streets platted and constructed within new subdivisions shall be public. In some extraordinary cases where there is no public right-of-way, and no feasible means of access

ARTICLE 4 SUBDIVISION REGULATIONS

4.3 TRANSPORTATION NETWORKS AND STREET DESIGNS

TABLE 4-5: FUNCTIONAL CLASSIFICATIONS AND APPLICABILITY

Classification	Intent and Characteristics	Applicability*
<i>Interstate</i>	The interstate system provides high-speed movement of large volumes of traffic with minimum interference. This is accomplished through the use of access control, divided roadways, and grade-separated interchanges. Expressways can be expected to accommodate lower volumes of traffic, but where uninterrupted, high-speed movement is desired across broad areas.	Located only on the City's initiative through its official Major Roadway System Plan. Volume Range : 40,000 – 80,000 ADT
<i>Principal Arterial</i>	A street of considerable continuity over long distances that provides direct connections to different areas within the City and surrounding areas for large volumes of vehicles. Arterial streets are characterized by few interruptions, except at major community destinations, topographical obstacles, or important natural features.	Principal Arterial Streets should be located every 1 to 1½ miles apart, except more frequent location of Minor Arterials and Collector streets can result in less frequent need for Principal Arterial Streets. Volume Range: 15,000 to 50,000 ADT
<i>Minor Arterial</i>	A street of moderate continuity over medium distances that provides direct access between adjacent neighborhoods or districts for medium volumes of traffic. Minor Arterial streets are occasionally interrupted or diverted by neighborhood destinations or natural barriers.	Minor Arterials Streets should be located every 1/3 to 1 mile apart, except more frequent location of Collector Streets can result in less frequent need for Minor Arterial Streets. Volume Range : 7,500 to 35,000 ADT
<i>Collector</i>	A street of moderate continuity over medium distances that provides direct access between adjacent neighborhoods or districts for low volumes of traffic. Collector Streets are occasionally interrupted or diverted by neighborhood destinations or natural barriers, or intersections with higher order streets.	Collector Streets should be located every ¼ to ½ mile apart. Volume Range : 2,500 to 7,500 ADT
<i>Local</i>	A street of limited continuity that provides connections, local circulation, and access within neighborhoods and districts for low volumes of traffic. Local streets are interrupted frequently by intersections with higher order street classifications or by interruptions or off-sets in the street grid (i.e. "T"-intersections). Local streets should still maintain high connectivity to the transportation network, but should be designed to discourage regional through traffic.	Local Streets to meet the connectivity standards in Section 4.3.3. Generally Local Streets are located every 250' to 1000' apart. Volume Range : High volume: < 2,500 ADT Low volume: < 250 ADT

* This Applicability is for general planning purposes and should be interpreted with the Transportation Master Plan portion of *PlanCheyenne*. Additionally, a TIS, TIA or Transportation Network Plan may propose alternate applicability, provided the Intent of this section is equally or better met by the modifications.

TABLE 4-6: STREET CONNECTIVITY / BLOCK SIZES

Context / Development Pattern*	Block Perimeter
<i>Downtown Neighborhood Business Activity Centers Mixed-use Activity Centers</i>	<ul style="list-style-type: none"> □ 1,600' maximum perimeter; □ 500' maximum on any one block face; □ 200' minimum on any one block face
<i>Community/Regional Commercial Activity Center</i>	<ul style="list-style-type: none"> □ 2,000' maximum; □ 600' maximum on any one block face; □ 250' minimum on any one block face
<i>Urban Residential</i>	<ul style="list-style-type: none"> □ 2,200' maximum; □ 800' maximum on any one block face; □ 250' minimum on any one block face
<i>Urban Transition Residential</i>	<ul style="list-style-type: none"> □ 2,600' maximum; □ 1,000' maximum on any one block face; □ 250' minimum on any one block face; <p>Except no requirement if subdivided according the Open Space Subdivision guidelines in <i>PlanCheyenne</i></p>
<i>Commercial</i>	<ul style="list-style-type: none"> □ 3,000' maximum perimeter □ 1,320' maximum on any one block face; □ 300' minimum on any one block face
<i>Industrial</i>	No requirement
<i>Rural / Agriculture</i>	No requirement
<i>Special Planning Districts</i>	No requirement; block sizes may be based on an overall development plan provided it supports the Transportation Network Plan for this property and adjacent properties.

* Per *PlanCheyenne*

to public right-of-way, it may be necessary for property owners to provide access by means of easements or other agreements and to construct a private access road. Such private access roads will not be constructed, maintained, repaired, or replaced by the City. Private accesses shall meet all requirements of the Cheyenne Fire Department.

In the event the owners of a private access road wish to convert the access to public use and public maintenance, the proposed road shall be dedicated to the public and accepted by the City as provided by law. The road or street shall be constructed at the applicant's expense in accordance with these standards and the plans, specifications, and construction approved as described for public streets.

4.3.3 Block Sizes and Connectivity Requirements

All Transportation Network Plans or subdivision applications platting new streets that connect to existing public streets shall propose an orderly system of blocks and lots. These standards shall be implemented consistent with the Transportation Master Plan, the Functional Classification and Street Design Type standards of this section, the Pedestrian and Bicycle Guidelines in Appendix G and any required Transportation Impact Study or Transportation Impact Assessment. Deviations that better meet the Intent of this Section may be required or approved by the City Council through applicable procedures and criteria established in Article 2.3.1, Subdivision Standard Waiver.

- a. **Block Sizes.** The block size standards are specified in Table 4-6, and shall be based upon the development pattern identified in the Comprehensive Plan. Standards are based on the perimeter formed by the centerline of the public street rights-of-way forming the block. For the purposes of the block perimeter measurement, alleys, cul-de-sacs, and disconnected streets are not considered streets. Blocks on the perimeter of the property being subdivided which are formed by the streets, any stub streets, and the subdivision boundary with property that may be subdivided in the future shall not exceed 60% of the maximum perimeter in Table 4-6. The length of the subdivision boundary is not considered in the 60% calculation. See Figure 4-1 for examples.
- b. **Arrangement.** Blocks shall be numbered consecutively within the subdivision and/or sections of an overall plat and arranged as follows:

1. All blocks shall be designed to provide two tiers of lots with each fronting on public streets.
 2. Double-frontage lots with lots backing to any street should be avoided. When double frontage lots or triple frontage lots are proposed as a division of land, the decision-making authority may require additional design elements either in the right-of-way or easements to mitigate the adverse impacts of double frontage lots. Conditions may include but are not limited to, requiring blocks with double frontage lots to back to portions of the Civic Open Space system in Section 4.4 such as trail corridors, required unified fencing designs, or other conditions. Where blocks with double frontage lots or triple frontage lots are allowed, the minimum block lengths do not apply.
 3. Blocks may be irregular in shape if necessary to serve important urban design goals, transportation planning goals, or address topographic and natural features, provided they still meet the general street network and connectivity standards.
 4. Side lot lines should be substantially at right angles or radial to the lot frontage lines along the block face. All lot arrangements and dimensions shall meet the requirements of the zoning district. Unique lot designs will only be considered where they promote the intent of this Section and good civic design.
 5. Whenever feasible, each lot should face the front of a similar lot across the street. Transitions between distinct lot types and land uses should occur at the rear of lots internal to the block rather than across the frontage and public streetscape.
- c. **Exceptions.** The following exceptions to the Street Connectivity / Block Size standards in Table 4-6 may be granted by the Planning Commission or City Council, after consideration of the recommendations of the Planning and Development Department.
1. *Natural Features & Open Space System.* Blocks or parcels abutting or containing important natural features, topographical constraints, or open space may be larger, provided the proposed street layout preserves important natural features or open space in accordance with the Open Space System standards in Section 4.4.
 2. *Regional Transportation Routes.* Blocks or parcels abutting intervening regional transportation routes such as highways or rail rights-of-way may be larger provided that street layouts and development patterns

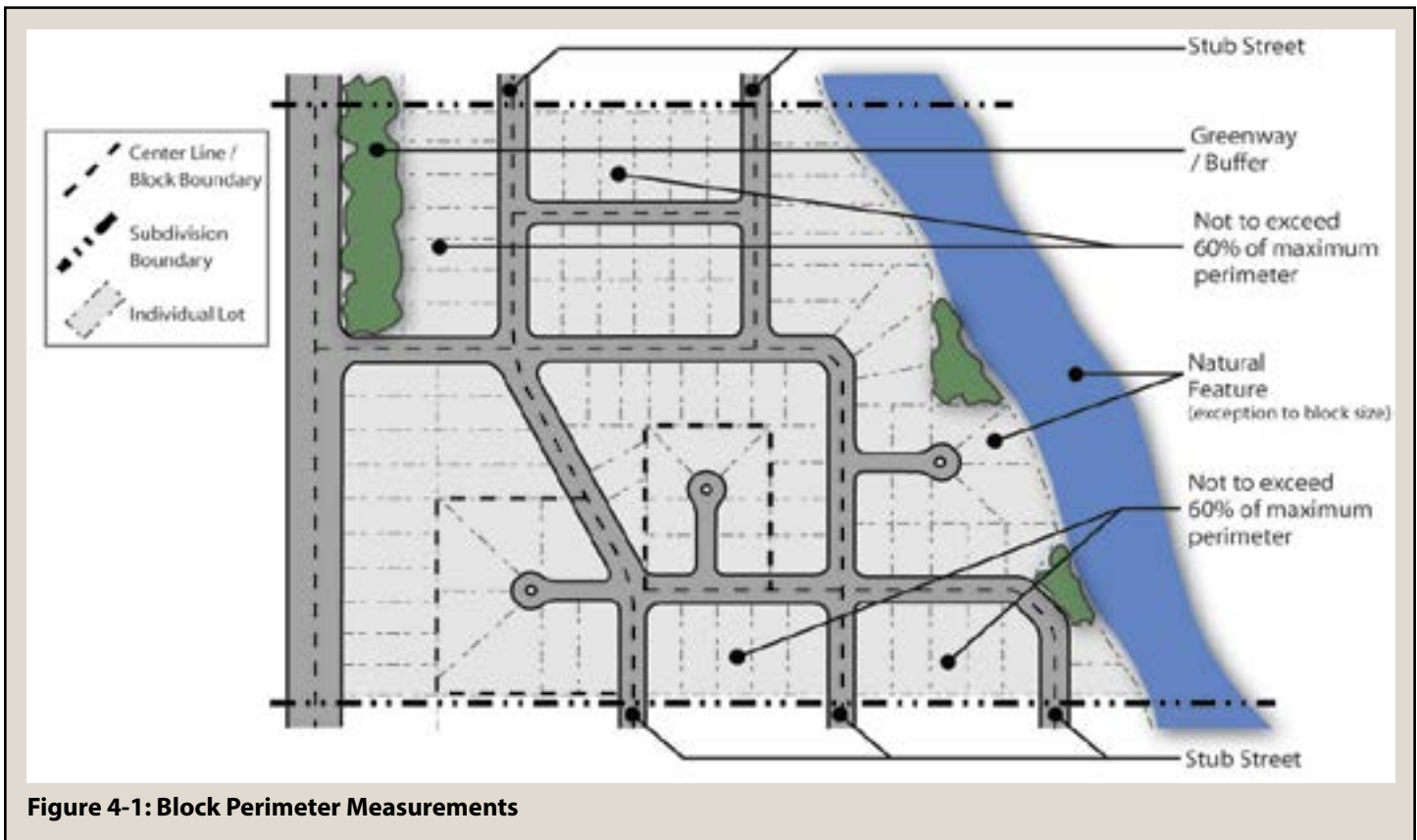

Figure 4-1: Block Perimeter Measurements

achieve local connectivity in all other ways possible.

3. *Civic Blocks.* In activity centers, blocks that serve more than 50% for Civic or Public uses, such as squares, plazas, or public parking, may be larger than the maximum allowed by Table 4-6.
4. *Rural Parcels.* A tract divided into rural lots substantially larger than called for under these regulations may be larger but shall be arranged to permit:
 - a. The opening of future streets in compliance with these regulations; and
 - b. A logical pattern of re-subdivision with minimal future disruption to buildings and structures that are proposed to be built under the original subdivision.

The Planning Commission or Planning Department may restrict building locations and site elements to permit future re-subdivision in compliance with these regulations, and require a sketch plan of re-subdivision demonstrating potential future division in compliance with all regulations to be submitted with

the preliminary plat.

5. *Oversized Parcels.* Where oversized parcels are platted for special districts such as employment campuses or large-scale commercial centers, internal access streets may be required by operation of applicable zoning and site design standards to mimic a block structure and the design and connectivity of the public streetscape.
6. *Infill Development.* Infill parcels of less than 10 acres, where connectivity opportunities are limited due to surrounding development and existing street and transportation patterns, may propose streets and blocks different from the standards in Table 4-6, provided opportunities to best meet the intent of this section have been exhausted.
7. *Low-density Residential.* Blocks zoned entirely LR or MR may use the following exceptions to the block perimeters:
 - (a) LR may have block perimeters up to 2,800' and maximum block face lengths up to 1,100';
 - (b) MR may have block perimeters up to 2,600' and

maximum block face lengths up to 1,000’;

(c) Any block using this exception shall have a pedestrian passage of at least 16’ bisecting the block and connecting to the overall pedestrian circulation for the area. The passage may be designated by easement or right-of-way. This passage shall have the following design elements:

- (1) A minimum 5’ sidewalk or in the case of a right-of-way dedication an alley may be constructed to city standards;
- (2) When a sidewalk is used in an easement, fences may be built as close as 2’ to the sidewalk and shall be no higher than 4’.
- (3) When a sidewalk is used in a right-of-way, fences are not allowed within the right-of-way and the passage shall be developed as a level 2 buffer meeting the landscape standards in Section 6.3.
- (4) Adjacent landowners shall be responsible for maintenance of the sidewalk and landscape unless dedicated and developed as an alley.

8. **Downtown Blocks.** In general, the block structure in the original City or replats to the original City shall not be modified via street vacation except in cases where City Council finds the following criteria are met, City Council may approve larger blocks:

- (a) Pedestrian movements will be maintained and assured.
- (b) Any street vacation will not adversely affect the transportation system including transit routes.
- (c) The development proposal will provide an overall and exceptional economic benefit to the downtown area.
- (d) The development proposal includes assurances of the project’s fit to enhance the context of the surrounding area.

d. **Alternative Compliance.** Parcels proposed for subdivisions that are larger than 35 acres may propose an Average Perimeter Block Size as a means of alternative compliance for Street Connectivity / Block Size standards in Table 4-6 by using the alternative standards in Table 4-7. In calculating the average, all parcels and blocks shall be used, including blocks formed by edges along open spaces and connections to the perimeter of the subdivision.

TABLE 4-7: ALTERNATIVE COMPLIANCE / AVERAGE PERIMETER BLOCK SIZE

Context / Development Pattern*	Average Block Perimeter
<i>Neighborhood Business Activity Centers</i> <i>Mixed-Use Commercial Activity Centers</i>	1,600’
<i>Community / Regional Commercial Activity Centers</i>	2,000’
<i>Urban Residential Neighborhood</i>	2,200’
<i>Urban Transition Residential Neighborhood</i>	2,600’

* Per PlanCheyenne

e. **Cul-de-sac and Disconnected Street Limitations.** In any case where a disconnected street such as a cul-de-sac may be permitted by the standards, exceptions, or alternative compliance provided in these regulations, they shall be further limited by the following standards and design requirements:

1. Cul-de-sacs shall not exceed more than 600’ measured from an intersecting and connected street to the end of the circle terminating the cul-de-sac.
2. Turnaround circles shall be constructed in accordance with the requirements of the Cheyenne Fire Department.
3. Street designs such as “loop streets” or “closes” are preferred as an alternative to cul-de-sacs. (See Figure 4-2).
4. The Planning Commission or Council may require alternative connections for bicycle or pedestrians at the end of disconnected streets to best meet the Intent of this section and the Pedestrian and Bicycle Guidelines in Appendix E, such as pathways at the ends of cul-de-sacs (See Figure 4-3).

f. **External Connections.** All new streets shall align with any existing or proposed streets on adjacent property, and shall continue and extend arterial, collector, and local streets within the proposed subdivision externally to the parcel boundary as follows:

1. New Arterial and Collector streets shall be provided at the intervals identified in the Applicability section of Table 4-5 Functional Classification and Applicability, and the adopted Transportation Master Plan. All Arterial and Collector streets shall be connected and extended to the boundary of the site.
2. Local street connections shall be provided and extended to the boundary of the site in a manner that all blocks and parcels in the subdivision meet the block

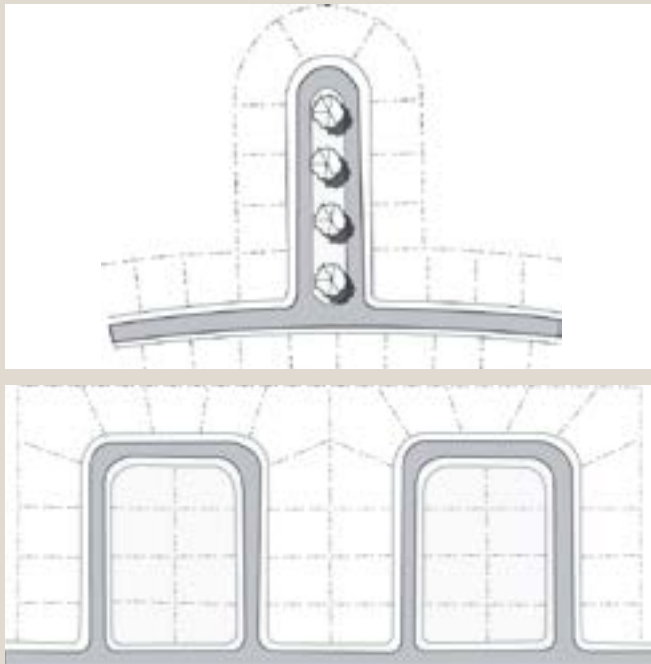

Figure 4-2: Alternatives to Cul-de-sacs, Loop Streets or “Closes” provide preferred alternatives to cul-de-sacs when disconnected streets are permitted.

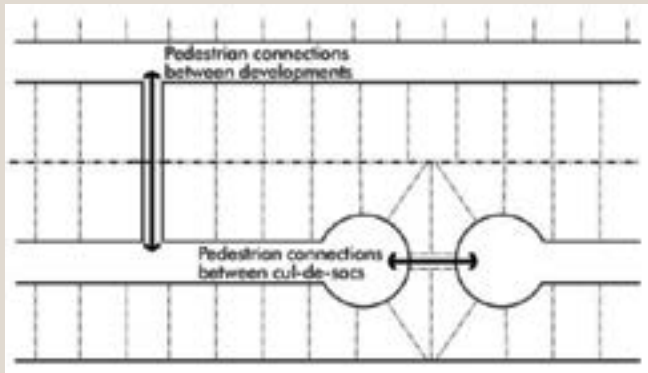

Figure 4-3: Pedestrian Connections between Developments and between Cul-de-sacs

standards in this sub-section. The City may require local streets to stub to the property edge where future development or re-subdivision of adjacent property is anticipated.

3. In addition to all of the above requirements for external connections, the following thresholds shall serve as a guide to meeting the overall Transportation Network Plan (4.3.2) and Block Size and Connectivity (4.3.3)

objectives.

- (a) All development with more than 20 dwelling units should have at least 2 connections or routes to an existing external Arterial or Collector street in the surrounding transportation network, or to a newly proposed Arterial or Collector street.
- (b) Developments over 50 dwelling units should have at least 3 connections or routes to an existing Arterial or Collector street, or a newly proposed Arterial or Collector street, and one additional connection or route for every increment of 50 dwelling units.
- (c) Extensions of or connections to existing and planned local streets can contribute to these connections or routes to the external network, provided the overall existing transportation network or a Transportation Network Plan for planned street achieves the thresholds in (a) and (b).
- (d) For interpreting this guidance, a “connection” shall be any access that does not overlap on any segment between the development block and the connection to the surrounding transportation network.

4.3.4 Street Design Types

- a. **Standards.** These standards include two distinct categories of street design types. Standard Design Types are based more heavily on the functional classification of the roadway. They are default standards based on traffic flow and function of the roadway. Context-based Design Types are based upon the integration with surrounding development patterns, land uses, and site designs. They are default standards based upon a well connected transportation network and coordinated planning with adjacent and abutting land uses. The technical design criteria, geometric and urban design standards, and cross sections for each street in this section are guidelines, and may be adjusted with concurrence of the City Engineer based upon the findings of any transportation impact study or other applicable considerations associated with a specific Transportation Network Plan, a specific corridor plan or other planning document affecting the public right-of-way. Tables 4-8 and 4-9 provide the applicability of each street type based upon the context (in reference to the Comprehensive Plan) and the functional classification (in reference to the Major Streets Plan or any specific Transportation Network Plan.)

ARTICLE 4 SUBDIVISION REGULATIONS

4.3 TRANSPORTATION NETWORKS AND STREET DESIGNS

TABLE 4-8: STANDARD DESIGN TYPES

<i>Design Type</i>	<i>Context</i> (Comprehensive Plan)	<i>Applicability</i> (Functional Class)
Principal Arterial	Commercial and Industrial Land Use areas, or connectors between commercial and industrial areas and residential areas.	Principal Arterial
Minor Arterial	Connectors between commercial and industrial areas and residential areas	Minor Arterial
Collector (A, B, C)	Connectors between arterials and local streets in commercial, residential and industrial areas.	Collector
Commercial / Industrial Street	Commercial and Industrial Land Use Areas	Local
Residential Street (A & B)	Urban Transition Residential Urban Neighborhoods Rural / Low-Density Neighborhoods	Local
Alley	Residential	Residential Service
	Non-residential	Commercial Service

TABLE 4-9: CONTEXT-BASED DESIGN TYPES

<i>Design Type</i>	<i>Context</i> (Comprehensive Plan)	<i>Applicability</i> (Functional Class)
Trafficway	Limited Application [only for highways and similar high volume/high speed roadways that enter urban areas and prior to transitions to other context-appropriate roads and prior to transitions to one of the other street types.]	Principal Arterial
Boulevard	Adjacent to Activity Centers Mixed-Use Commercial Emphasis Mixed-Use Residential Emphasis Mixed-Use Employment Campus	Principal Arterial
Avenue	Activity Centers	Principal Arterial Minor Arterial
Parkway	Urban Residential Mixed-use Residential Emphasis Urban Transition Residential	Minor Arterial Collector
Street	Activity Centers Mixed-Use Commercial Emphasis Mixed-Use Residential Emphasis Mixed-Use Employment Campus Urban Neighborhoods (supporting Civic Uses or Parks)	Minor Arterial Collector Local
Neighborhood Street A	Urban Neighborhoods	Collector Local
Neighborhood Street B	Urban Neighborhoods	Local
Neighborhood Street C	Urban Neighborhoods	Local
Rural Road	Rural / Low-density Neighborhoods	Minor Arterial Local
Alley	Residential	Residential Service
	Non-residential	Commercial Service

- b. **Civic Open Space Credit.** Where the Streetscape Area in the right-of-way is in excess of the standard cross sections in subsection c. and where these areas are designed to create a greater civic amenity by meeting the Open Space System standards in Section 4.4 for Greenways, Courtyards or Plazas, the areas in excess of the minimum right-of-way standards may contribute to the Open Space requirement of the proposed subdivision.
- c. **Street Cross Sections.** The standard cross-sections for each street type are indicated below. They include geometric and urban design standards for the right-of-way, technical design parameters, and access standards based upon each specific design type. The streetscape shall be constructed according to the design specifications in Appendix G Streetscape Design, Planning, and Maintenance Guidelines and the standards in Appendix E, Pedestrian and Bicycle Guidelines.

ARTICLE 4 SUBDIVISION REGULATIONS

4.3 TRANSPORTATION NETWORKS AND STREET DESIGNS

Standard Roadway: Principal Arterial

Description: The Principal Arterial design type serves long and intermediate-distance travel. Principal Arterials provide for high regional continuity within the overall transportation network, and accommodate high speeds and volumes.

Context and Applicability: The Principal Arterial design type creates and supports major commercial and industrial districts that are regional in scale and reliant on a high degree of automobile usage. They also form the outer edges of residential neighborhoods, but need to be buffered from neighborhoods due to their intensity.

Standard Roadway Classification: Principal Arterial

TECHNICAL CRITERIA	
	Principal Arterial
Daily Traffic Volume	15,000 – 32,000 (4-lane) 24,000 – 50,000 (6-lane)
Design Speed	50 MPH
Speed Limit	40 - 45 MPH
Design Vehicle	WB-67
Minimum Sight Distance (Driveway / Intersections)	1,030'
Stopping Sight Distance	400'
Minimum Intersection Spacing	1,320'
Distance Between Signals	2,640'
Minimum Access separation - corner	660'
Minimum Access Separation – other access	660'
Driveway Approach and Street Configuration	Radial Curb Return
Required Curb & Gutter Type	6" vertical
Minimum Full Depth HPB Section	8"
Minimum Composite Section Depths (HBP/ ABC)	6" / 8"
Grade (Max / Min)	6% / 0.5%
Maximum Super Elevation	0.6
Acceleration / Deceleration Lanes	Per Section 4.3.7

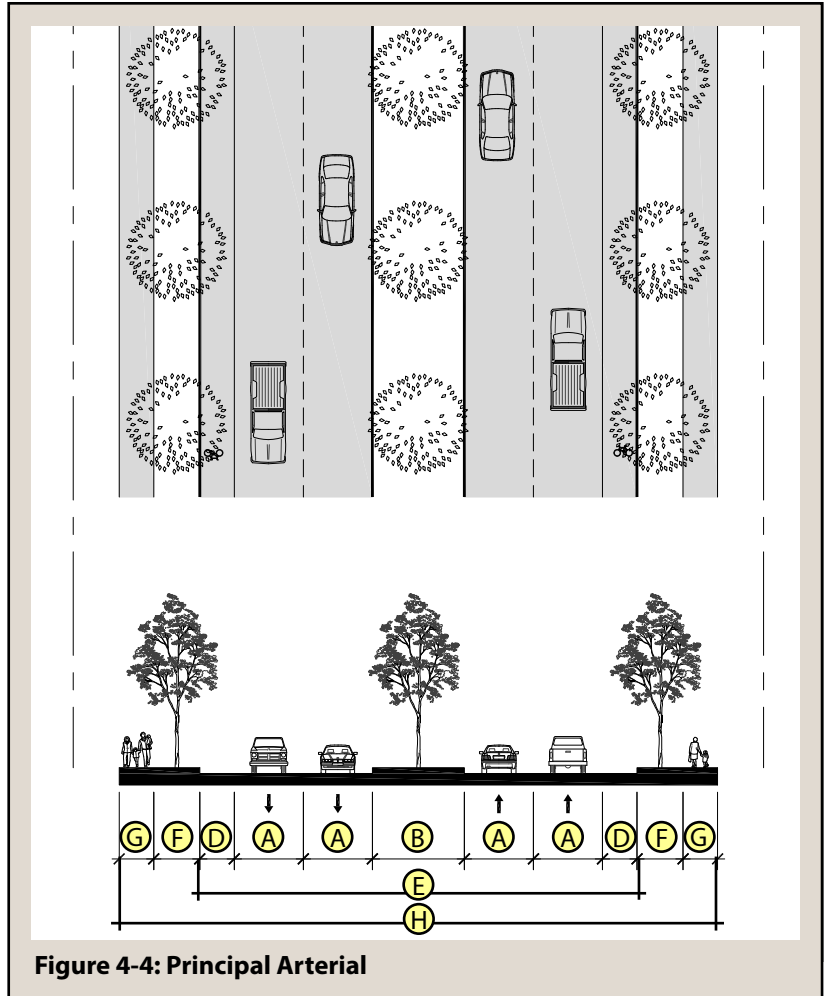

Figure 4-4: Principal Arterial

GEOMETRIC AND URBAN DESIGN STANDARDS		
		Principal Arterial
(A)	Number of Lanes (Width)**	4-6 (12')
(B)	Median Type (Width)	Raised (16' minimum) (4' at intersections)
(C)	Parking	none
(D)	Shoulder	6'
(E)	Roadway Width (BC-BC)	76' minimum (4-lane) 100' minimum (6-lane)
(F)	Tree Lawn / Landscape	8' minimum
(G)	Pedestrian Area	6' minimum
(H)	Right-of-Way Width*	120' minimum (4-lane) 140' minimum (6-lane)

* Added ROW allocated between additional landscape median, tree lawn or landscape area based on context, and to reconcile utility and landscape conflicts per Section 4.5.5.

** Master Transportation Plan shall provide primary guidance.

ARTICLE 4 SUBDIVISION REGULATIONS

4.3 TRANSPORTATION NETWORKS AND STREET DESIGNS

Standard Roadway: Minor Arterial

Description: The Minor Arterial design type serves long and intermediate-distance travel. Minor Arterials provide for high regional continuity within the overall transportation network, and accommodate moderate speeds and volumes.

Context and Applicability: The Minor Arterial design type creates and supports commercial and industrial districts with access from surrounding neighborhoods. They also form the outer edges of residential neighborhoods or may create a central spine for larger neighborhoods at the lower ranges of traffic volumes and speeds.

Standard Roadway Classification: Minor Arterial

TECHNICAL CRITERIA	
	Minor Arterial
Daily Traffic Volume	15,000 – 32,000 (4-lane w/ median) 7,500 – 18,000 (2-lane w/ median)
Design Speed	45 MPH
Speed Limit	35 – 40 MPH
Design Vehicle	WB-67
Minimum Sight Distance (Driveway / Intersections)	830'
Stopping Sight Distance	325'
Minimum Intersection Spacing	660'
Distance Between Signals	1,320'
Minimum Access separation - corner	330'
Minimum Access separation – other access	330'
Driveway Approach and Street Configuration	Radial Curb Return
Required Curb & Gutter Type	6" vertical
Minimum Full Depth HPB Section	7"
Minimum Composite Section Depths (HBP/ABC)	5" / 8"
Grade (Max / Min)	6% / 0.5%
Maximum Super elevation	0.6
Acceleration / Deceleration Lanes	Per Section 4.3.7

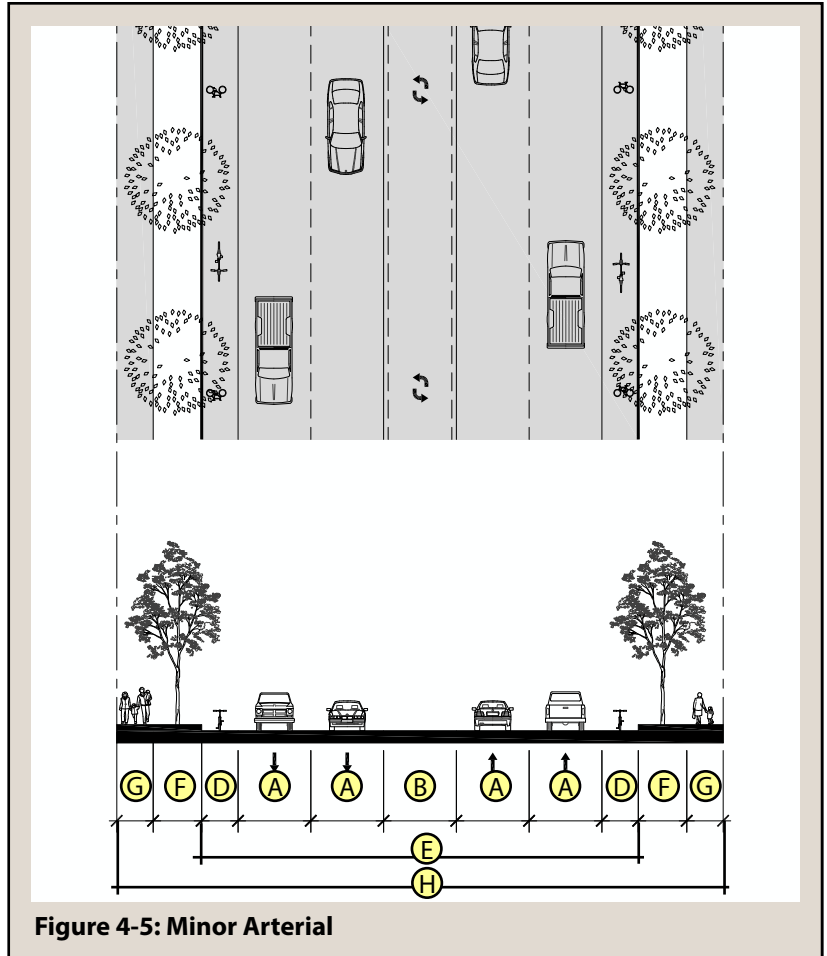

Figure 4-5: Minor Arterial

GEOMETRIC AND URBAN DESIGN STANDARDS		
		Minor Arterial
(A)	Number of Lanes (Width)	2-4 (12')
(B)	Median Type (Width)	Painted (12') – may be raised if 4-lane
(C)	Parking	none
(D)	Bicycle Lane / Shoulder	6'
(E)	Roadway Width (BC-BC)	72' minimum (4-lane w/ median) 48' minimum (2-lane w/ median)
(F)	Tree Lawn / Landscape	8' minimum
(G)	Pedestrian Area	6' minimum
(H)	Right-of-Way Width*	100' minimum

* Added ROW allocated between additional landscape median, tree lawn or landscape area based on context, and to reconcile utility and landscape conflicts per Section 4.5.5.

ARTICLE 4 SUBDIVISION REGULATIONS

4.3 TRANSPORTATION NETWORKS AND STREET DESIGNS

Standard Roadway: Collector (Types A, B, and C)

Description: The Collector design type serves intermediate and short-distance travel. Collectors provide for moderate continuity within the overall street network, and accommodate moderate speeds and volumes.

Context and Applicability: The Collector design type serves as connectors between arterial and local streets in both residential and non-residential contexts.

Standard Roadway Classification: Collector

TECHNICAL CRITERIA			
	Collector A (w/o parking)	Collector B (w/o parking; w/ center turn-lane)	Collector C (w/ parking)
Daily Traffic Volume	5,000 – 7,000	6,000 – 10,000	5,000 – 7,500
Design Speed	35 MPH		
Speed Limit	30 – 35 MPH		
Design Vehicle	B-40		
Minimum Sight Distance (Driveway / Intersections)	660'		
Stopping Sight Distance	200'		
Minimum Intersection Spacing	330'		
Distance Between Signals	n/a		
Minimum Access separation - corner	150'		
Minimum Access separation – other access	150' (Collector A) / 75' (Collector B & C)		
Driveway Approach and Street Configuration	Flared		
Required Curb & Gutter Type	6" vertical		
Minimum Full Depth HPB Section	6"		
Minimum Composite Section Depths (HBP/ABC)	4" / 8"		
Grade (Max / Min)	8% / 0.5%		
Maximum Super elevation	0.6		
Acceleration / Deceleration Lanes	N/A		

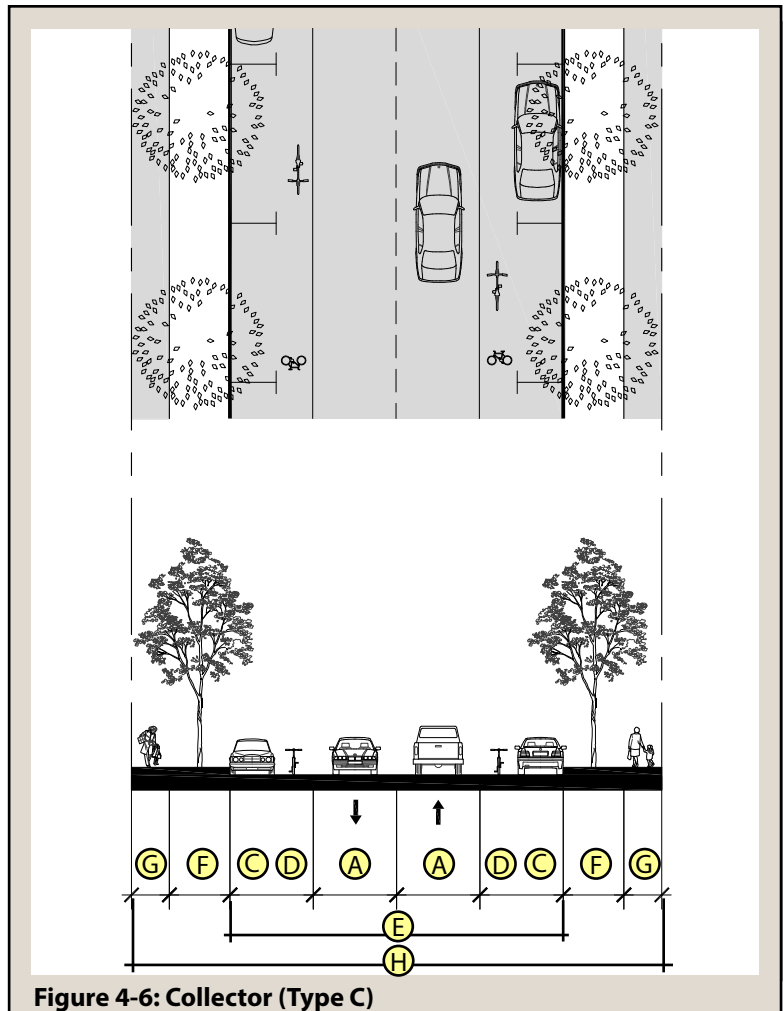

Figure 4-6: Collector (Type C)

GEOMETRIC AND URBAN DESIGN STANDARDS				
		Collector A (w/o parking)	Collector B (w/o parking; w/ center turn-lane)	Collector C (w/ parking)
(A)	Number of Lanes (Width)	2 (12')	2 (12')	2 (11')
(B)	Median Type (Width)	none	Painted (12')	none
(C)	Parking	none	none	Shared w/ bike lane
(D)	Bicycle Lane / Shoulder	6'	6'	11' joint parking/bike lane
(E)	Roadway Width (BC-BC)	36' minimum	48' minimum	44' minimum
(F)	Tree Lawn / Landscape	8'	8'	8'
(G)	Pedestrian Area**	6'	6'	5'
(H)	Right-of-Way Width*	70'	80'	70'

* Added ROW allocated between additional tree lawn or landscape area based on context, and to reconcile utility and landscape conflicts per Section 4.5.5.

** If an attached sidewalk is allowed via subdivision waiver then a minimum 6' wide sidewalk is required.

ARTICLE 4 SUBDIVISION REGULATIONS

4.3 TRANSPORTATION NETWORKS AND STREET DESIGNS

Standard Roadway: Commercial / Industrial

Description: The Commercial / Industrial design type serves as primary access to non-residential uses that may have a higher volume of truck and delivery traffic, and which need a high degree of automobile access for patrons or employees. The Commercial / Industrial design type serves intermediate and short-distance travel within the overall transportation network, and accommodates lower volumes and speeds.

Context and Applicability: Commercial and Industrial Areas outside of "Activity Centers."

Standard Roadway Classification: Local

TECHNICAL CRITERIA	
	Commercial / Industrial
Daily Traffic Volume	3,500 – 7,500
Design Speed	25 MPH
Speed Limit	25 MPH
Design Vehicle	WB-50 (Commercial) WB-67 (Industrial)
Minimum Sight Distance (Driveway / Intersections)	260'
Stopping Sight Distance	150'
Minimum Intersection Spacing	200'
Distance Between Signals	n/a
Minimum Access separation - corner	100'
Minimum Access separation – other access	30'
Driveway Approach and Street Configuration	Flared
Required Curb & Gutter Type	6" vertical
Minimum Full Depth HPB Section	6"
Minimum Composite Section Depths (HBP/ABC)	4" / 8"
Grade (Max / Min)	10% / 0.5%
Maximum Super elevation	0.6
Acceleration / Deceleration Lanes	N/A

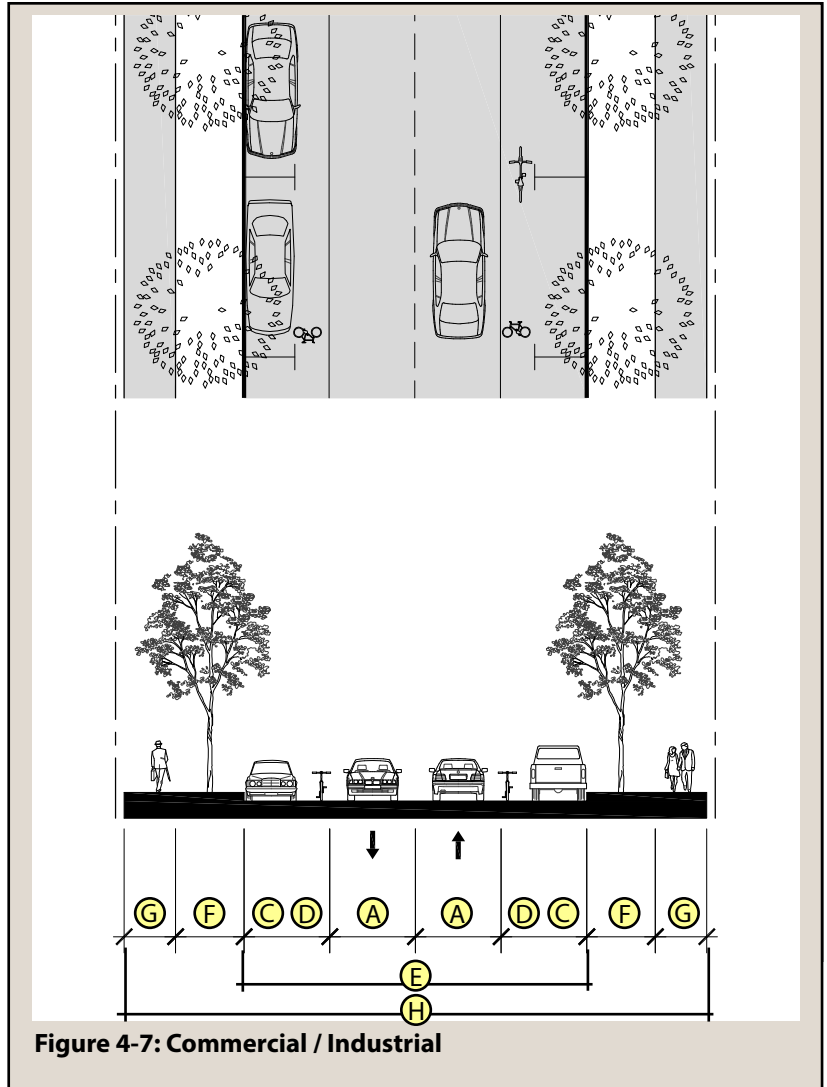

Figure 4-7: Commercial / Industrial

GEOMETRIC AND URBAN DESIGN STANDARDS

		Industrial A	Commercial B
(A)	Number of Lanes (Width)	2 (15')	2 (10')
(B)	Median Type (Width)	none	none
(C)	Parking	7' parking	10' bike /parking
(D)	Bicycle Lane / Shoulder	none	Shared parking/bike
(E)	Roadway Width (BC-BC)	44' minimum	40' minimum
(F)	Tree Lawn / Landscape*	6' minimum	8' minimum
(G)	Pedestrian Area	4.5' minimum	6' minimum
(H)	Right-of-Way Width**	70' minimum	70' minimum

* If an attached sidewalk is allowed via subdivision waiver then a minimum 6' wide sidewalk is required.

** Added ROW allocated between additional tree lawn or landscape area based on context, and to reconcile utility and landscape conflicts per Section 4.5.5.

ARTICLE 4 SUBDIVISION REGULATIONS

4.3 TRANSPORTATION NETWORKS AND STREET DESIGNS

Standard Roadway: Residential (Types A & B)

Description: The Residential Design type serves as primary access to residential uses that may have a higher volume of pedestrian traffic. The Residential design type serves intermediate and short-distance travel within the overall transportation network, and accommodates lower volumes and speeds.

Context and Applicability: Residential Areas

Standard Roadway Classification: Local

TECHNICAL CRITERIA		
	Residential A	Residential B
Daily Traffic Volume	0 – 2,500	0 – 250
Design Speed	25 MPH	
Speed Limit	25 MPH	
Design Vehicle	SU-30	
Minimum Sight Distance (Driveway / Intersections)	260'	
Stopping Sight Distance	150'	
Minimum Intersection Spacing	200'	
Distance Between Signals	n/a	
Minimum Access separation - corner	15'	15'
Minimum Access separation – other access	12'	12'
Driveway Approach and Street Configuration	Flared	
Required Curb & Gutter Type	6" vertical or rolled	
Minimum Full Depth HPB Section	4.5"	
Minimum Composite Section Depths (HBP/ ABC)	3" / 6"	
Grade (Max / Min)	10% / 0.5%	
Maximum Super elevation	0.6	
Acceleration / Deceleration Lanes	N/A	

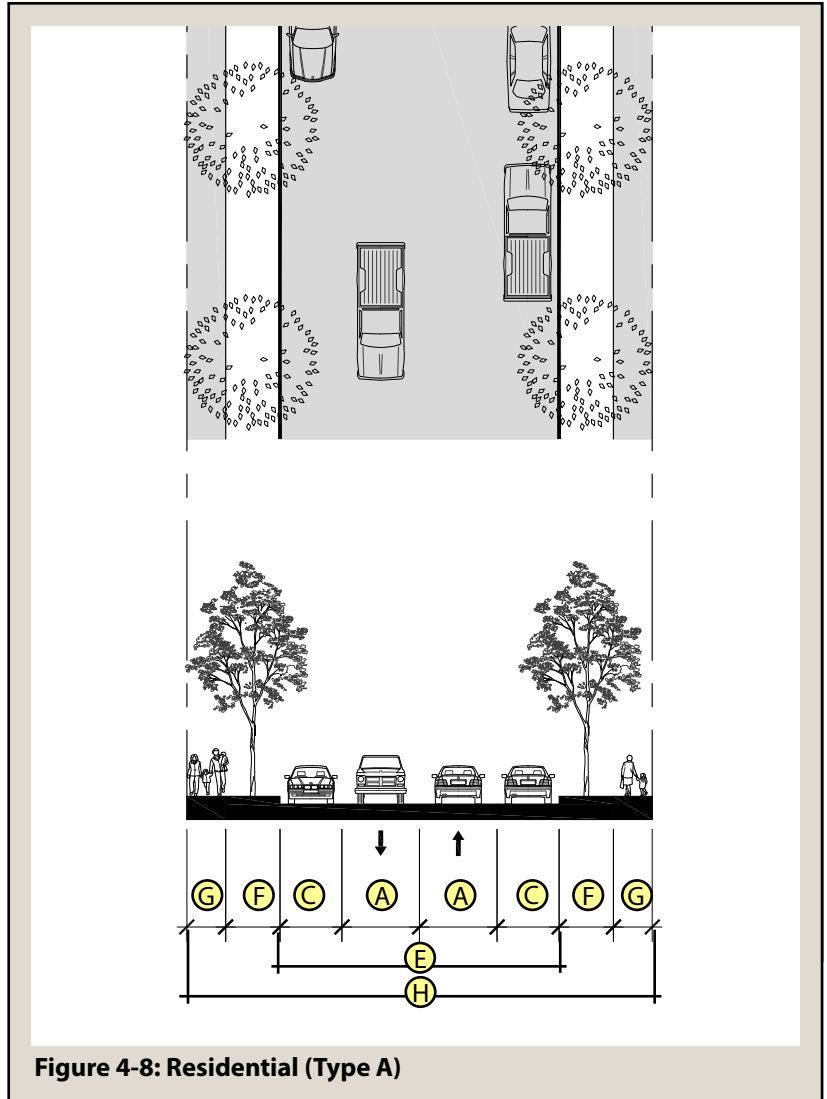

Figure 4-8: Residential (Type A)

GEOMETRIC AND URBAN DESIGN STANDARDS			
		Residential A	Residential B
(A)	Number of Lanes (Width)	2 (10')	2 (10')
(B)	Median Type (Width)	none	none
(C)	Parking	8' (both sides)	6' (both sides)
(D)	Bicycle Lane / Shoulder	none	none
(E)	Roadway Width (BC-BC)	36' minimum	32' minimum
(F)	Tree Lawn / Landscape*	7'	7'
(G)	Pedestrian Area	5'	5'
(H)	Right-of-Way Width	60' minimum	56' minimum

* If an attached sidewalk is allowed via subdivision waiver then a minimum 6' wide sidewalk is required.

ARTICLE 4 SUBDIVISION REGULATIONS

4.3 TRANSPORTATION NETWORKS AND STREET DESIGNS

Context-based Roadway: Trafficway

Description: The Trafficway design type serves long to intermediate-distance travel. Trafficways provide for moderate continuity, with higher speeds, and volumes within the overall street network.

Context and Applicability: The Trafficway design type is a high-capacity roadway through urban areas.

Standard Roadway Classification: Principal Arterial

TECHNICAL CRITERIA	
	Trafficway
Daily Traffic Volume	15,000 – 36,000 (4-lane) 24,000 – 54,000 (6-lane)
Design Speed	55 MPH
Speed Limit	45 – 50 MPH
Design Vehicle	WB-67
Minimum Sight Distance (Driveway / Intersections)	1,030'
Stopping Sight Distance	400'
Minimum Intersection Spacing	1,320'
Distance Between Signals	2,640'
Minimum Access separation - corner	660'
Minimum Access separation - other access	660'
Driveway Approach and Street Configuration	Radial Curb Return
Required Curb & Gutter Type	6" vertical
Minimum Full Depth HPB Section	8"
Minimum Composite Section Depths (HBP/ABC)	6" / 8"
Grade (Max / Min)	6% / 0.5%
Maximum Super elevation	0.6
Acceleration / Deceleration Lanes	Per Section 4.3.7

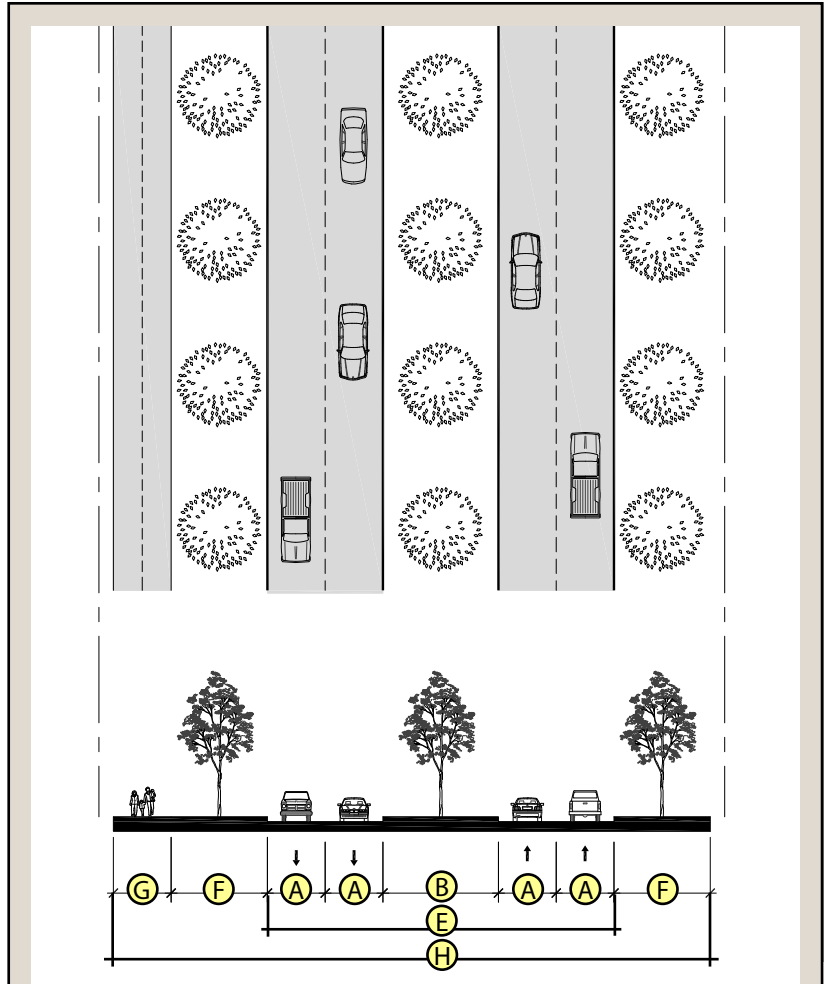

Figure 4-9: Trafficway

GEOMETRIC AND URBAN DESIGN STANDARDS		
		Trafficway
(A)	Number of Lanes (Width)	4-6 (12')
(B)	Median Type (Width)	Raised (24')
(C)	Parking	none
(D)	Bicycle Lane / Shoulder	None – see Pedestrian Area in G below
(E)	Roadway Width (BC-BC)	72' minimum (4-lane) 96' minimum (6-lane)
(F)	Tree Lawn / Landscape	20' minimum 32' minimum w/ multi-use trail
(G)	Pedestrian Area	12' Multi-use trail in largest landscape edge (optional)
(H)	Right-of-Way Width*	130' minimum (4-lane) 150' minimum (6-lane)

* Added ROW allocated between additional landscape median, tree lawn or landscape area based on context, and to reconcile utility and landscape conflicts per Section 4.5.5.

ARTICLE 4 SUBDIVISION REGULATIONS

4.3 TRANSPORTATION NETWORKS AND STREET DESIGNS

Context-based Roadway: Boulevard

Description: The Boulevard design type balances a high-capacity and moderate- to high-speed roadway, with a high degree of pedestrian amenity and accessibility for adjacent development. The right-of-way is designed in two key components – the central portions for through traffic movement, and the edges for slip lanes, pedestrian amenities, and enhanced urban design.

Context and Applicability: The Boulevard design type is applied to limited segments of arterial roads, primarily adjacent to and forming the edges and gateways of:

- Regional or Community Activity Centers
- Mixed-Use Employment Emphasis; or
- Mixed-Use Commercial Emphasis.

It has limited application based on appropriate intersection designs of slip lanes with cross streets and with the through portion of the Boulevard.

Standard Roadway Classification: Principal Arterial

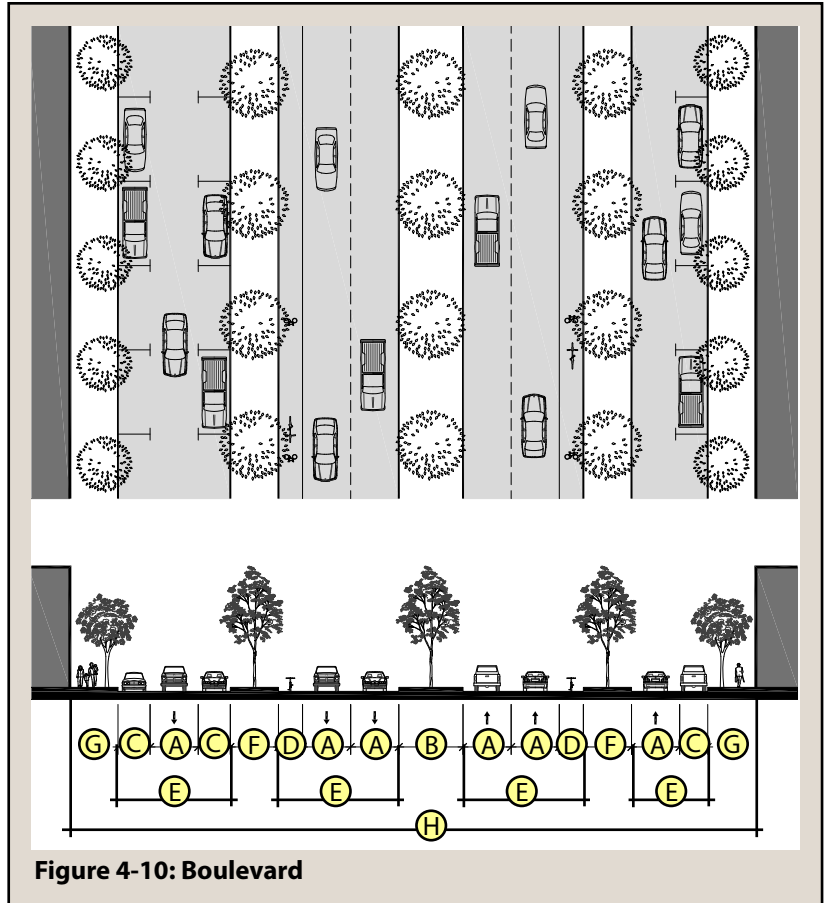

Figure 4-10: Boulevard

TECHNICAL CRITERIA	
	Boulevard
Daily Traffic Volume	15,000 – 32,000 (4-lane)
Design Speed	50 MPH
Speed Limit	35 – 45 MPH 10-20 MPH (slip lanes)
Design Vehicle	WB-67
Minimum Sight Distance (Driveway / Intersections)	1,030'
Stopping Sight Distance	400'
Minimum Intersection Spacing	1,320' 300' (slip lanes)
Distance Between Signals	2,640'
Minimum Access separation - corner	660' 200' (slip lanes)
Minimum Access separation – other access	660' 200' (slip lanes)
Driveway Approach and Street Configuration	Radial Curb Return
Required Curb & Gutter Type	6" vertical
Minimum Full Depth HPB Section	8"
Minimum Composite Section Depths (HBP/ABC)	6" / 8"
Grade (Max / Min)	6% / 0.5%
Maximum Super elevation	0.6
Acceleration / Deceleration Lanes	Per Section 4.3.7

GEOMETRIC AND URBAN DESIGN STANDARDS		
		Boulevard
(A)	Number of Lanes (Width)	4 (12') 1 slip/frontage lane either or both sides (10')
(B)	Median Type (Width)	Raised (16') (4' at intersections)
(C)	Parking	7' on slip lanes 8' if on both sides of slip lane
(D)	Bicycle Lane / Shoulder	6'
(E)	Roadway Width (BC-BC)	76' minimum (excludes slip lanes)
(F)	Tree Lawn / Landscape	12' minimum between Boulevard and slip lanes 8' if no slip lanes Tree-wells included in pedestrian area on slip lanes
(G)	Pedestrian Area	6' if no slip lanes 12' on slip lane
(H)	Right-of-Way Width	119' – 128' minimum (one slip lane) 146' – 164' minimum (two slip lanes)

ARTICLE 4 SUBDIVISION REGULATIONS

4.3 TRANSPORTATION NETWORKS AND STREET DESIGNS

Context-based Roadway: Avenue (Types A & B)

Description: The Avenue design type serves intermediate to short distance travel. Avenues provide moderate continuity within the overall street network, and accommodate slower speeds and moderate volumes. The right-of-way is designed for intensive pedestrian use.

Context and Applicability: The Avenue design type is applied to limited segments of arterial roads within or adjacent to:

- Regional, Community, or Neighborhood Activity Centers
- Mixed-Use Employment Emphasis;
- Mixed-Use Commercial Emphasis; or
- Mixed-Use Residential Emphasis.

It is most applicable for zoning districts and sites that allow buildings to front directly on the street.

Standard Roadway Classification: Principal Arterial (Type A) or Minor Arterial (Type B)

TECHNICAL CRITERIA		
	Avenue A	Avenue B
Daily Traffic Volume	20,000 – 28,000	12,000 – 20,000
Design Speed	35 MPH	30 MPH
Speed Limit	30 – 35 MPH	25-30 MPH
Design Vehicle	WB-67	WB-50
Minimum Sight Distance (Driveway / Intersections)	660'	500'
Stopping Sight Distance	250'	200'
Minimum Intersection Spacing	330'	330'
Distance Between Signals	660'	660'
Minimum Access separation - corner	200'	200'
Minimum Access separation - other access	200'	75'
Driveway Approach and Street Configuration	Radial Curb Return	Radial Curb Return or Flared
Required Curb & Gutter Type	6" vertical	6" vertical
Minimum Full Depth HBP Section	8"	7"
Minimum Composite Section Depths (HBP/ABC)	6" / 8"	5" / 8"
Grade (Max / Min)	8% / 0.5%	8% / 0.5%
Maximum Super elevation	0.6	0.6
Acceleration / Deceleration Lanes	N/A	N/A

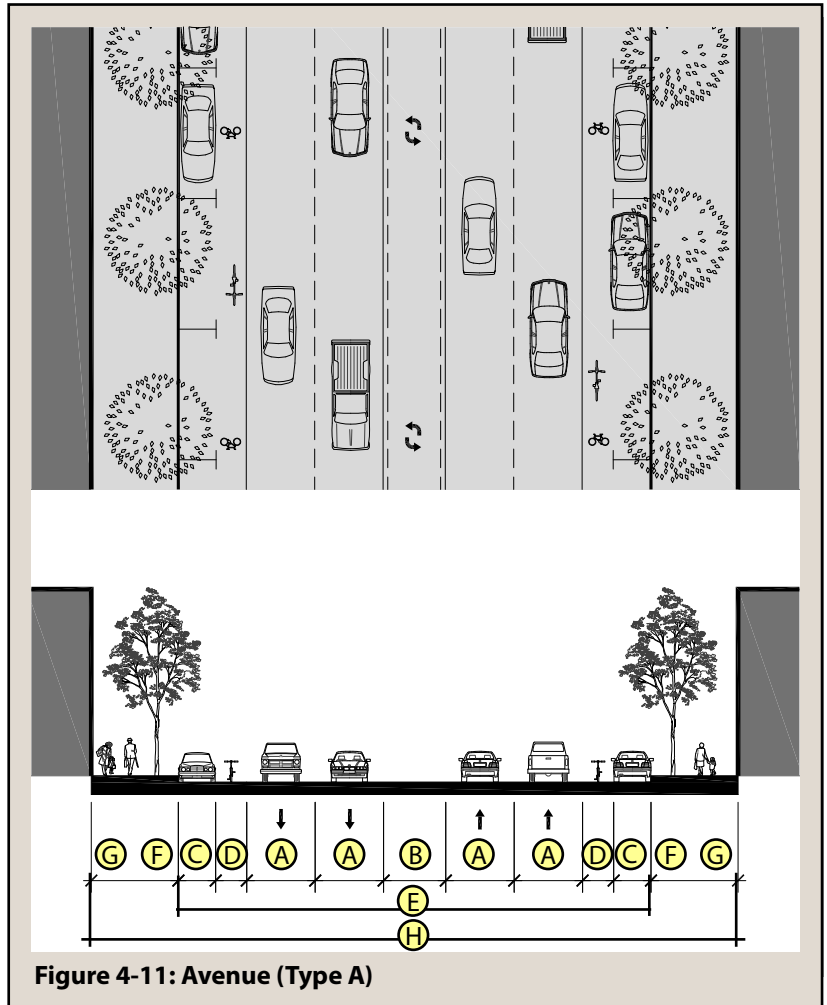

Figure 4-11: Avenue (Type A)

GEOMETRIC AND URBAN DESIGN STANDARDS			
		Avenue A	Avenue B
(A)	Number of Lanes (Width)	4 (11')	2 (11')
(B)	Median Type (Width)	Painted (10'), raised optional (12')	Painted (10') optional
(C)	Parking	6'	6'
(D)	Bicycle Lane / Shoulder	5'	5'
(E)	Roadway Width (BC-BC)	76' – 78' minimum	44' minimum (w/o median) 54' minimum (w/ median)
(F)	Tree Lawn / Landscape	Tree wells included in pedestrian area, or minimum 8' tree lawn	Tree-wells included in pedestrian area
(G)	Pedestrian Area	8' if tree lawn 14' w/o tree lawn	13'
(H)	Right-of-Way Width	110' minimum*	70' minimum (w/o median) 80' minimum (w/ median)

* Added ROW allocated between additional landscape median, tree lawn or landscape area based on context, and to reconcile utility and landscape conflicts per Section 4.5.5.

ARTICLE 4 SUBDIVISION REGULATIONS

4.3 TRANSPORTATION NETWORKS AND STREET DESIGNS

Context-based Roadway: Parkway (Types A & B)

Description: The Parkway design type serves long to intermediate distance travel. Parkways provide for high continuity within the overall transportation network, and accommodate moderate speeds and volumes. The right-of-way is designed for increased natural amenity in both the median and the street edge.

Context and Applicability: The Parkway design type is applied to extended segments of arterial or collector roads to provide a continuous natural amenity throughout:

- Mixed-Use Employment Emphasis;
- Mixed-Use Residential Emphasis;
- Urban Residential; and
- Urban Transition Residential.

The Parkway design type is most applicable to alternative through routes around activity centers, diverting through traffic from the more intense commercial and pedestrian-oriented streets in the network, and providing a continuous and uniform design feature across different zoning districts and development sites.

Standard Roadway Classification: Minor Arterial (Type A) or Collector (Type B)

TECHNICAL CRITERIA		
	Parkway A	Parkway B
Daily Traffic Volume	12,000 – 30,000	10,000 – 12,500
Design Speed	35 MPH	30 MPH
Speed Limit	30 – 35 MPH	25-30 MPH
Design Vehicle	WB-50	WB-50
Minimum Sight Distance (Driveway / Intersections)	660'	500'
Stopping Sight Distance	250'	200'
Minimum Intersection Spacing	330'	330'
Distance Between Signals	660'	660'
Minimum Access separation - corner	200'	200'
Minimum Access separation – other access	150'	75'
Driveway Approach and Street Configuration	Flared	Flared
Required Curb & Gutter Type	6" vertical	6" vertical
Minimum Full Depth HPB Section	7"	6"
Minimum Composite Section Depths (HBP/ABC)	5" / 8"	4" / 8"
Grade (Max / Min)	8% / 0.5%	8% / 0.5%
Maximum Super elevation	0.6	0.6
Acceleration / Deceleration Lanes	N/A	N/A

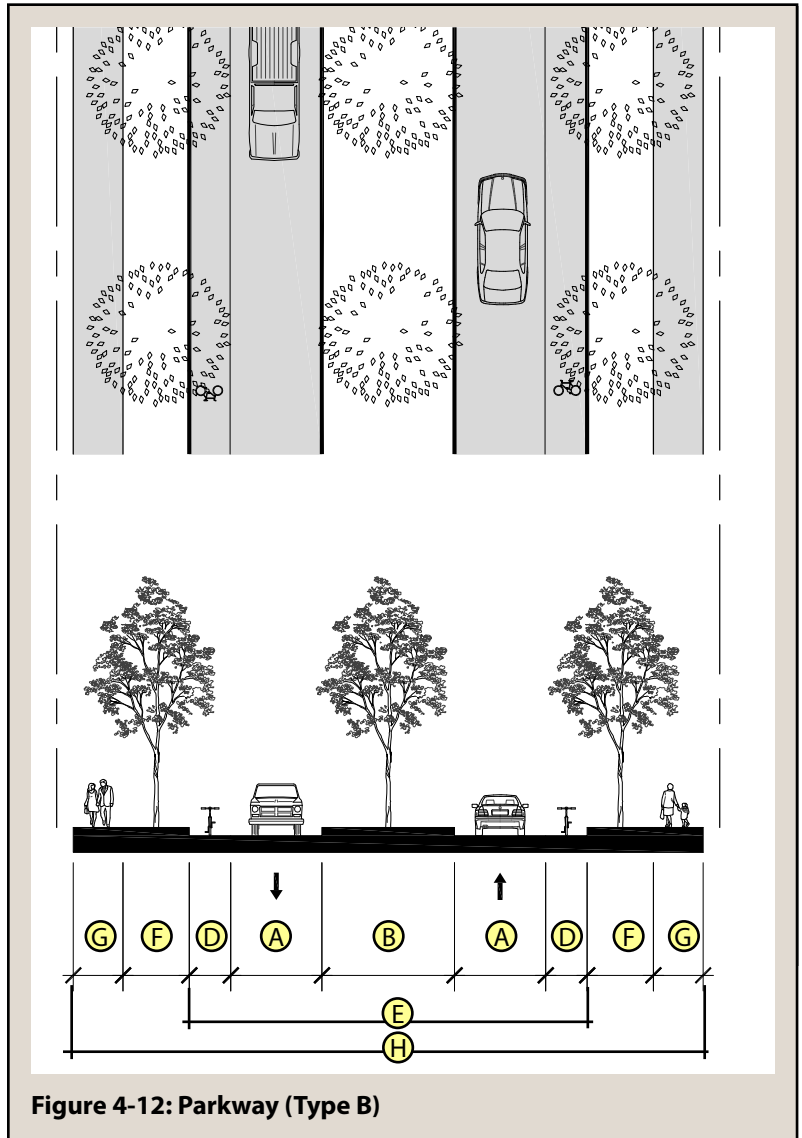

Figure 4-12: Parkway (Type B)

GEOMETRIC AND URBAN DESIGN STANDARDS			
		Parkway A	Parkway B
(A)	Number of Lanes (Width)	4 (11')	2 (11')
(B)	Median Type (Width)	Raised (16' minimum)	Raised (16' minimum)
(C)	Parking	none	none
(D)	Bicycle Lane / Shoulder	5'	5'
(E)	Roadway Width (BC-BC)	70' minimum	48' minimum
(F)	Tree Lawn / Landscape	12' minimum	8' minimum
(G)	Pedestrian Area	6'	6'
(H)	Right-of-Way Width*	110' minimum	80' minimum

* Added ROW allocated between additional landscape median, tree lawn or landscape area based on context, and to reconcile utility and landscape conflicts per Section 4.5.5.

ARTICLE 4 SUBDIVISION REGULATIONS

4.3 TRANSPORTATION NETWORKS AND STREET DESIGNS

Context-based Roadway: Street

Description: The Street design type serves intermediate to short distance travel. Streets provide for moderate continuity within a highly-connected street network, and accommodate slower speeds and low volumes. The right-of-way is designed for intensive pedestrian use.

Context and Applicability: The Street design type is applied to streets of a highly connected street network within or adjacent to:

- Regional, Community, or Neighborhood Activity Centers
- Mixed-Use Employment Emphasis;
- Mixed-Use Commercial Emphasis;
- Mixed-Use Residential Emphasis; or
- Urban Neighborhoods (serving Civic Uses or Parks)

It is most applicable for zoning districts and sites that allow buildings to front directly on the street or similar locations that require on-street parking.

Standard Roadway Classification: Collector or Local

TECHNICAL CRITERIA	
	Street
Daily Traffic Volume	3,500 – 7500 Collector / Local
Design Speed	20 MPH
Speed Limit	20 MPH
Design Vehicle	SU-30
Minimum Sight Distance (Driveway / Intersections)	260'
Stopping Sight Distance	150'
Minimum Intersection Spacing	200'
Distance Between Signals	N/A
Minimum Access separation - corner	200'
Minimum Access separation – other access	75'
Driveway Approach and Street Configuration	Flared
Required Curb & Gutter Type	6" vertical
Minimum Full Depth HPB Section	6"
Minimum Composite Section Depths (HBP/ABC)	4" / 8"
Grade (Max / Min)	10% / 0.5%
Maximum Super elevation	0.6
Acceleration / Deceleration Lanes	N/A

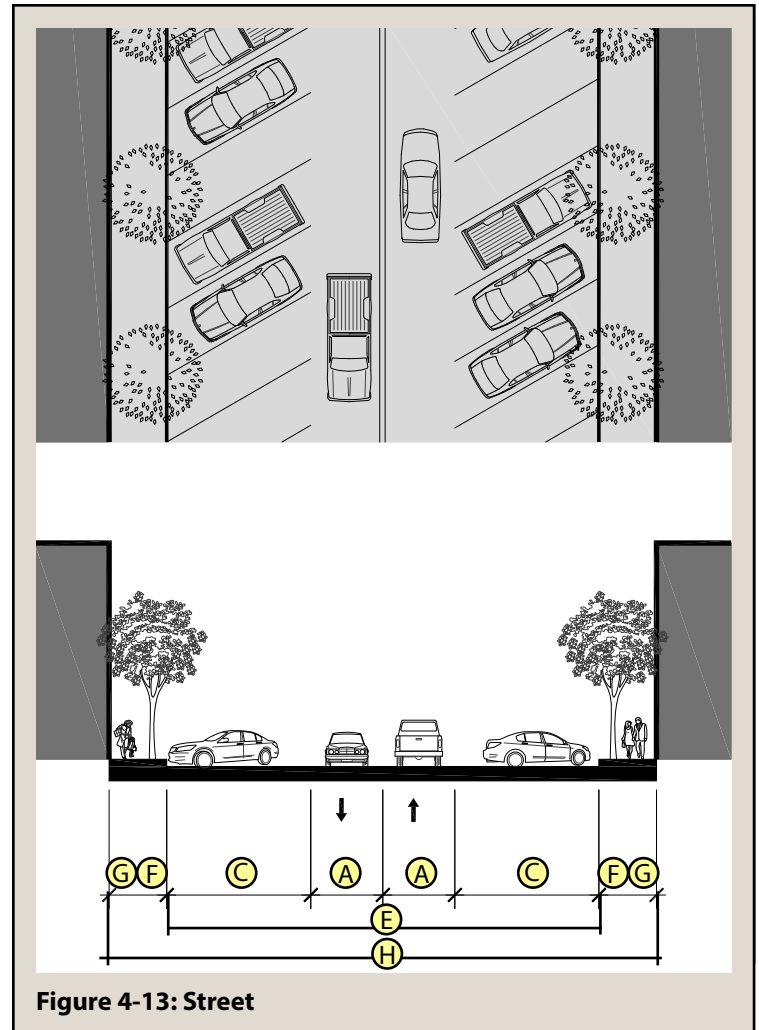

Figure 4-13: Street

GEOMETRIC AND URBAN DESIGN STANDARDS		
		Street
(A)	Number of Lanes (Width)	2 - 4 (10')
(B)	Median Type (Width)	none
(C)	Parking	7' parallel 22' minimum diagonal
(D)	Bicycle Lane / Shoulder	none
(E)	Roadway Width (BC-BC)*	34' - 54' minimum (parallel parking) 64' - 84' minimum (angled parking)
(F)	Tree Lawn / Landscape	Treewells included in pedestrian area
(G)	Pedestrian Area	8' - 12'
(H)	Right-of-Way Width*	50' - 78' minimum (parallel parking) 80' - 108' minimum (diagonal parking)

* Alternate sides of the street may provide different parking, which will alter the required roadway width and right-of-way width.

ARTICLE 4 SUBDIVISION REGULATIONS

4.3 TRANSPORTATION NETWORKS AND STREET DESIGNS

Context-based Roadway: Neighborhood Street (Types A, B, & C)

Description: The Neighborhood Street design type serves intermediate to short distance travel. Streets provide for limited continuity within a highly-connected street network, discouraging through traffic but maintaining connectivity. They accommodate slow speeds and low volumes and right-of-way is designed for intensive pedestrian use.

Context and Applicability: The Neighborhood Street design type is applied to collector or local streets within or adjacent to in Urban Neighborhoods and Urban Transition Neighborhoods where there is a highly connected street network.

Standard Roadway Classification: Collector (Type A) and Local (Types A, B & C)

TECHNICAL CRITERIA			
	Neighborhood Street A	Neighborhood Street B	Neighborhood Street C
Daily Traffic Volume	0 -2,000 (local) 2,000 – 5,000 (collector)	0 – 200	0 – 200
Design Speed	20 MPH	20 MPH	20 MPH
Speed Limit	20 MPH	20 MPH	20 MPH
Design Vehicle	SU-30	SU-30	SU-30
Minimum Sight Distance (Driveway / Intersections)	260'	260'	260'
Stopping Sight Distance	100'	100'	100'
Minimum Intersection Spacing	200'	200'	200'
Distance Between Signals	N/A	N/A	N/A
Minimum Access separation - corner	15'	15'	15'
Minimum Access separation – other access	12'	12'	12'
Driveway Approach and Street Configuration	Flared	Flared	Flared
Required Curb & Gutter Type	6" vertical	6" vertical	6" vertical
Minimum Full Depth HPB Section	4.5"	4.5"	4.5"
Minimum Composite Section Depths (HBP/ABC)	3" / 6"	3" / 6"	3" / 6"
Grade (Max / Min)	10% / 0.5%	10% / 0.5%	10% / 0.5%
Maximum Super Elevation	0.6	0.6	0.6
Acceleration / Deceleration Lanes	N/A	N/A	N/A

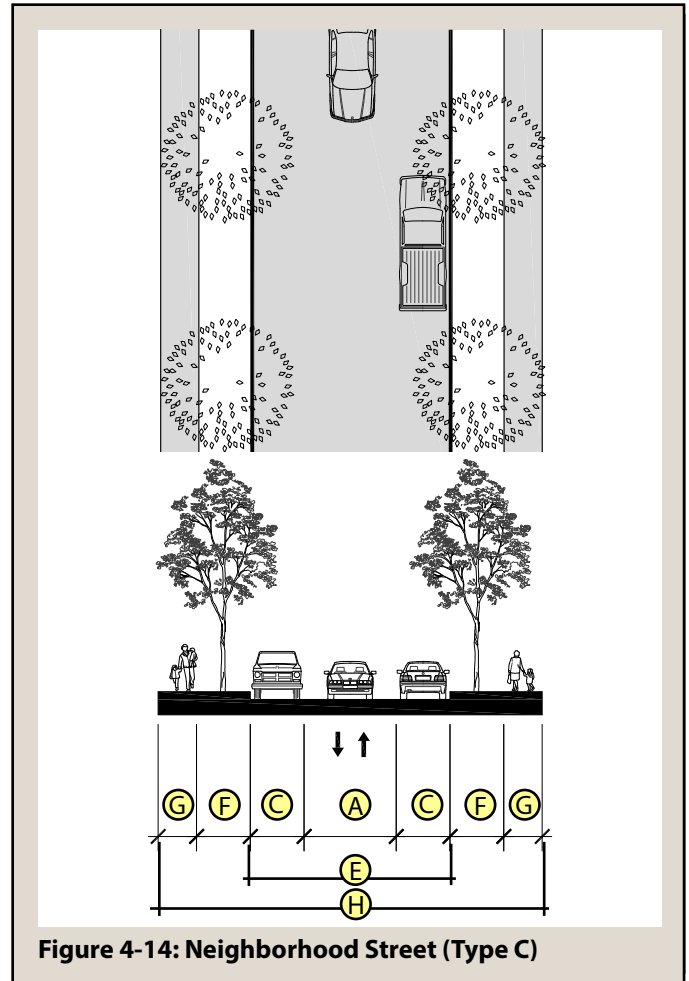

Figure 4-14: Neighborhood Street (Type C)

GEOMETRIC AND URBAN DESIGN STANDARDS				
		Neighborhood Street A	Neighborhood Street B	Neighborhood Street C
A	Number of Lanes (Width)	2 (10') local 2 (12') collector	2 (10')	1 (12' – yield lane)
B	Median Type (Width)	none	none	none
C	Parking	6' (both sides local) 8' (one-side collector)	6' parallel (one side)	7' parallel (both sides)
D	Bicycle Lane / Shoulder	none	none	none
E	Roadway Width (BC-BC)	32' minimum	26' minimum	26' minimum
F	Tree Lawn / Landscape	8'	7'	7'
G	Pedestrian Area	6'	5'	5'
H	Right-of-Way Width	60' minimum	50' minimum	50' minimum

ARTICLE 4 SUBDIVISION REGULATIONS

4.3 TRANSPORTATION NETWORKS AND STREET DESIGNS

Context-based Roadway: Rural Road (Types A & B)

Description: The Rural Road design type serves long to intermediate distance travel. Rural roads provide for moderate continuity within the overall transportation network, and accommodate slower speeds and moderate volumes. The right-of-way is designed to emphasize natural features and have low impacts on topography and vegetation.

Context and Applicability: The Rural Road design type is applied to arterial roads or local roads in more remote or low-intensity development areas, where little future or long-range development intensification is anticipated, primarily:

- Rural areas
- Low-density Neighborhoods;
- Urban Transition Residential

Standard Roadway Classification: Minor Arterial (Type A) or Local (Type B)

TECHNICAL CRITERIA		
	Rural Road A	Rural Road B
Daily Traffic Volume	7,500 – 12,000	0-2,500
Design Speed	35 MPH	25 MPH
Speed Limit	30 – 35 MPH	20-25 MPH
Design Vehicle	WB-50	WB-50
Minimum Sight Distance (Driveway / Intersections)	660'	660'
Stopping Sight Distance	200'	200'
Minimum Intersection Spacing	330'	330'
Distance Between Signals	N/A	N/A
Minimum Access separation - corner	330'	220'
Minimum Access separation – other access	330'	75'
Driveway Approach and Street Configuration	Flared	Flared
Required Curb & Gutter Type	none	None
Minimum Full Depth HPB Section	7"	7"
Minimum Composite Section Depths (HBP/ABC)	5" / 8"	5" / 8"
Grade (Max / Min)	10% / 0.5%	10% / 0.5%
Maximum Super elevation	0.6	0.6
Acceleration / Deceleration Lanes	Per Section 4.3.7	N/A

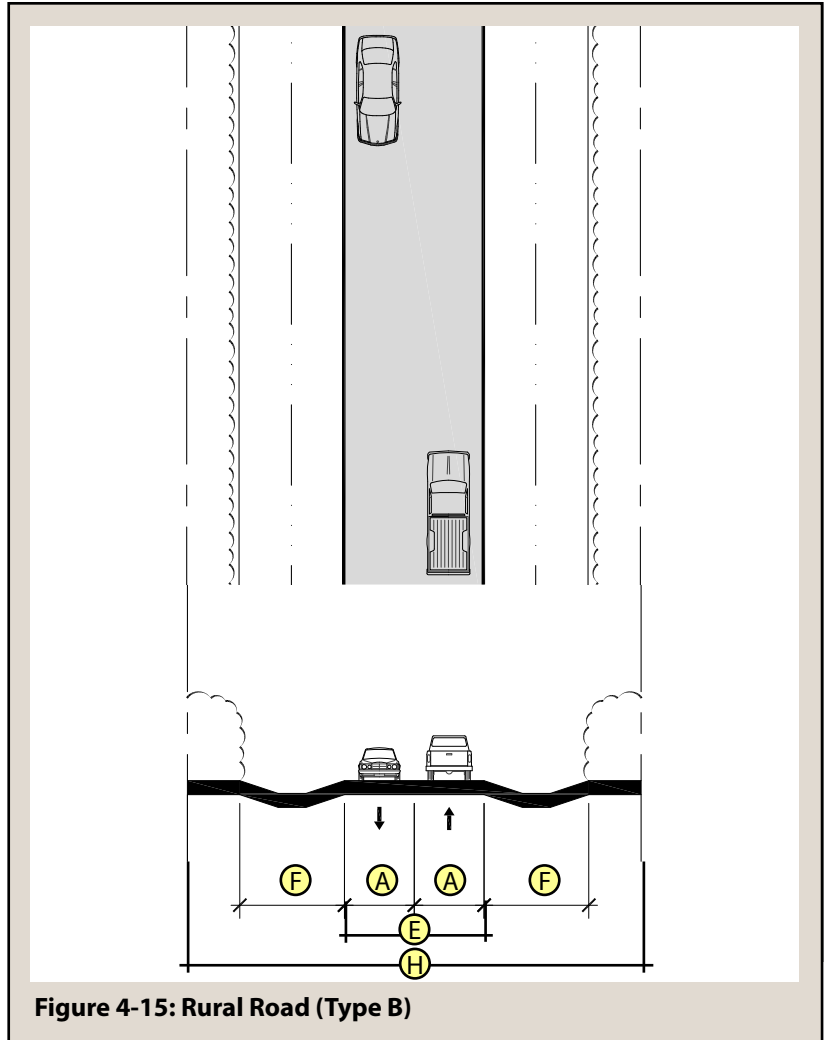

Figure 4-15: Rural Road (Type B)

GEOMETRIC AND URBAN DESIGN STANDARDS			
		Rural Road A	Rural Road B
(A)	Number of Lanes (Width)	2 (11')	2 (10')
(B)	Median Type (Width)	Swale (24')	Swale (15') - Optional
(C)	Parking	None	None
(D)	Bicycle Lane / Shoulder	5'	None
(E)	Roadway Width (BC-BC)	56' minimum	35' minimum (w/ median) 20' minimum (w/o median)
(F)	Tree Lawn / Landscape	15' minimum swale and natural area	15' minimum swale and natural area
(G)	Pedestrian Area	None or separate greenway/trail	none
(H)	Right-of-Way Width*	90' minimum	50' minimum (w/o median) 65' minimum (w/ median)

* Added ROW allocated between additional landscape median or landscape area based on context, and to reconcile utility and landscape conflicts per Section 4.5.5.

ARTICLE 4 SUBDIVISION REGULATIONS

4.3 TRANSPORTATION NETWORKS AND STREET DESIGNS

Context-based Roadway: Alley (Non-residential & Residential)

Description: The Alley design type serves for service and common access to the interior of blocks at a low capacity and low speed.

Context and Applicability: The Alley design type is applied to residential and non-residential areas that need more discrete or secondary access to blocks and lots. It is most effective where the continuity of streets and streetscapes need to be preserved from repetitive curb cuts, and where a highly connected street network allows alleys to access blocks off of secondary streets.

Standard Roadway Classification: Service / Access

TECHNICAL CRITERIA		
	Non-residential	Residential
Daily Traffic Volume	0- 500	0-500
Design Speed	10 MPH	10 MPH
Speed Limit	10 MPH	10 MPH
Design Vehicle	SU-30	SU-30
Minimum Sight Distance (Driveway / Intersections)	210'	210'
Stopping Sight Distance	100'	100'
Minimum Intersection Spacing	N/A	N/A
Distance Between Signals	N/A	N/A
Minimum Access separation - corner	N/A	N/A
Minimum Access separation - other access	N/A	N/A
Driveway Approach and Street Configuration	Flared	Flared
Required Curb & Gutter Type	None	None
Minimum Full Depth HPB Section	4.5"	4.5"
Minimum Composite Section Depths (HBP/ ABC)	3" / 6"	3" / 6"
Grade (Max / Min)	10% / 0.3%	10% / 0.3%
Maximum Super elevation	N/A	N/A
Acceleration / Deceleration Lanes	N/A	N/A

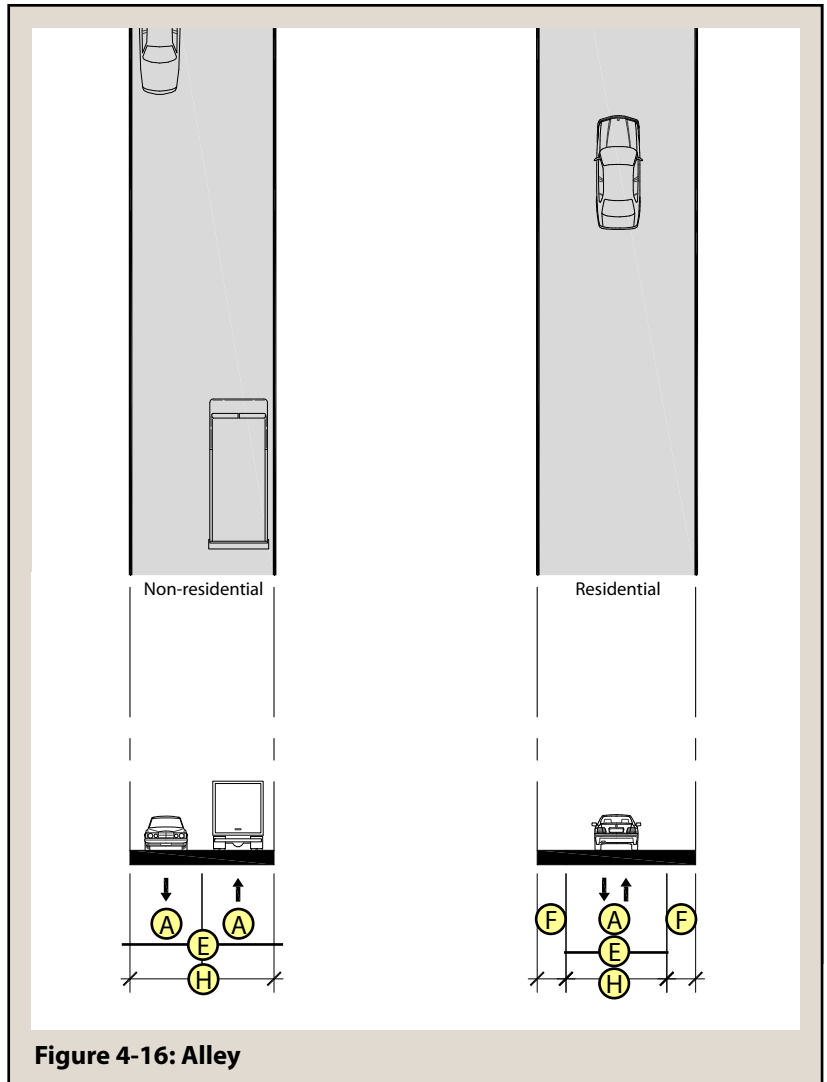

Figure 4-16: Alley

GEOMETRIC AND URBAN DESIGN STANDARDS			
		Non-residential	Residential
(A)	Number of Lanes (Width)	2 (8' - 10') (up to 12' for frequent truck access)	1 (12' - 16' yield)
(B)	Median Type (Width)	None	None
(C)	Parking	None	None
(D)	Bicycle Lane / Shoulder	none	None
(E)	Roadway Width (BC-BC)	16' - 24'	12' - 16'
(F)	Tree Lawn / Landscape*	none	2' - 4'
(G)	Pedestrian Area	None	None
(H)	Right-of-Way Width	16' - 24' minimum	16' - 24' minimum

* Tree Lawn/Landscape for alleys is generally only required to be a permeable area unless associated with property access.

4.3.5 Intersection Designs

The standards in this sub-section apply to intersections of streets. These standards shall be implemented consistent with the Pedestrian and Bicycle Guidelines in Appendix E and any required Transportation Impact Study or Transportation Impact Assessment. Alternative standards that better meet the Intent of this Section may be required or approved based on a Transportation Impact Study or Transportation Impact Assessment, or through the Waiver process specified in Article 2.

- a. **Generally.** Intersections of streets in the transportation network plan or new intersections to existing streets in any subdivision application shall meet the following general requirements:
 1. The angle of intersections of streets shall be as close to 90 degrees as possible and shall not vary more than 10 degrees from a right angle.
 2. Intersections should be aligned or offset by at least:
 - (a) 150' from intersecting local streets;
 - (b) 200' from intersecting collector streets; and
 - (c) 300' from intersecting arterial streets.
 3. Additional right-of-way may be required for auxiliary lanes near intersections to accommodate speed change lanes or turn lanes, where they are required by the findings of a Transportation Impact Study or Transportation Impact Assessment.
 4. Cross pans (valley gutters across intersections) shall be a minimum of 12' wide. A minimum transition of 30' shall be made in the street preceding the cross pan to remove the crown. Cross pans shall not be used as a traffic calming device. In general, cross pans should not be used across arterial or collector streets.
- b. **Corner Radii.** Corner radii should balance the need for vehicles making turning movements and pedestrians crossing the street according to the specific context. In general Table 4-10 provides corner radii requirements. In areas where large vehicles will make frequent turning movements or where there is no parking lane adjacent to the curb, the City Engineer may require greater turning radii. In areas where slower vehicle speeds are desired or high pedestrian traffic is expected, the City Engineer may allow smaller turning radii. Actual centerline turning movements of typical vehicles, lane locations, intersection angles, or other geometric configurations of the specific intersection may be justifications for larger or smaller requirements.

TABLE 4-10: INTERSECTION CURB RADII

<i>Intersection Type</i>	<i>Radii</i>
Local / Local	15'
Local / Collector	15' – 20'
Local / Arterial	20' – 25'
Collector / Collector	20' - 25'
Collector / Arterial	25' - 30'
Arterial / Arterial	30'

- c. **Sight distances.** Proper lines of sight shall be maintained at all intersections. Sight distance requirements are a function of speed of the roadway and control points of intersecting streets.
 1. **Controlled Intersections.** The proper line of sight shall be triangle formed by a diagonal line along an unobstructed view from the stopping point to all points from 1' to 3.5' above the centerline of the intersected street for a distance based on that street's design speed, and the center lines of each roadway. Reconstruction of the horizontal and vertical curvature along the roadway and side slopes adjacent to the roadway may be necessary to increase sight distances. Sight distances are included in the Technical Criteria for each individual street type based on design speed. The sight distances shall be measured according to Figures 4-17 and 4-18.
 2. **Highway Grade Adjustment.** On Freeways/Expressway or Principal Arterial classification streets, sight distances shall be adjusted for any grade of 3% or greater using the adjustment factor in Table 4-11 as a ratio of the otherwise required sight distance.

TABLE 4-11 ADJUSTMENT FACTOR FOR GRADE

<i>Grade</i>	<i>Adjustment Factor</i>
3% to 4.9% upgrade	0.9
5% to 7% upgrade	0.8
3% to 4.9% downgrade	1.2
5% to 7% downgrade	1.35

- 3. **Uncontrolled Intersections.** At uncontrolled intersections, the proper sight distances shall be a triangle formed by the diagonal line drawn across the corner at 35' back along the curb or edge of street pavement from the point of intersection. (Figure 4-19).



Figure 4-17: Corner Sight Distance (no on-street parking)

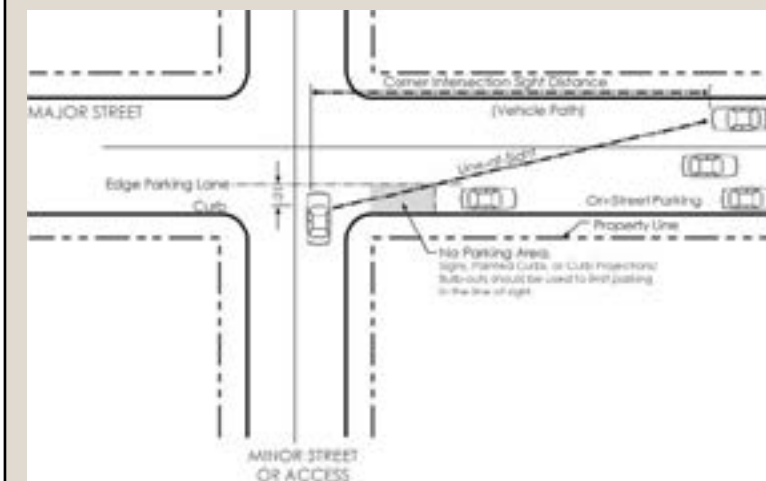

Figure 4-18: Corner Sight Distance (on-street parking)

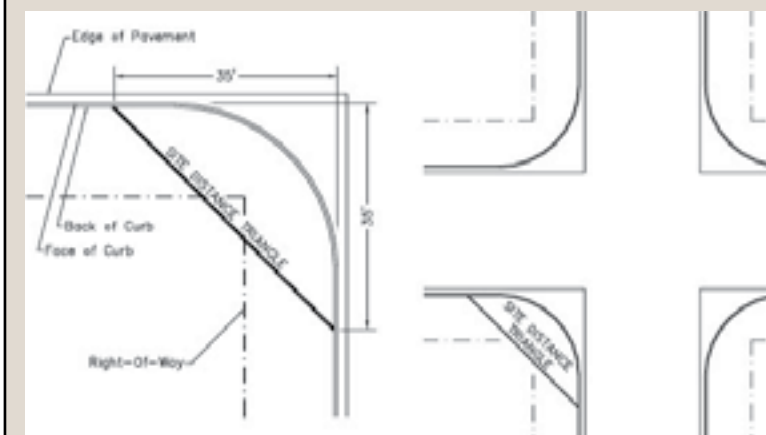

Figure 4-19: Corner Sight Distance for Yield- or No-control intersections

4. *Limited Allowances.* The sight triangle shall be kept free from all obstructions between 2.5' and 12' above street grades. Landowners are responsible to maintain visibility. The City Engineer may approve the location of light or sign poles 18" or less in diameter in the sight distances or triangle if visibility is not obstructed. Deciduous trees may be permitted to encroach into the clearance triangle at controlled intersections provided that the trees are planted with a minimum 2" caliper and the lowest branch of any such tree shall be at least 12' from grade at maturity and trees are placed according to the *Streetscape Design, Planning and Maintenance Standards* in Appendix G and no tree may encroach into the triangle formed by the diagonal line drawn across the corner at 35' back along the curb or edge of street pavement from the point of intersection. Ornamental type trees should not encroach into any clearance triangle.

d. *Stopping Sight Distance.* Stopping sight distance shall be provided on all streets in accordance with the technical criteria for each specific street type. Stopping sight distance shall be adjusted for any grade in excess of 3% using the adjustment factors in Table 4-11. Stopping sight distance for vertical curves is specified in Table 4-12.

<i>Design Speed (mph)</i>	<i>Stopping Sight Distance (ft)</i>	<i>Rate of vertical curvature, K*</i>
15	80	3
20	115	7
25	155	12
30	200	19
35	250	29
40	305	44
45	360	61
50	425	84
55	495	114

* Rate of vertical curvature, K, is the length of curve (L) per percent algebraic difference in intersecting grades (A). $K=L/A$.

Source: Adapted from American Association of State Highway and Transportation Officials, *A Policy on Geometric Design of Highways and Streets*, 2001. Washington, DC: AASHTO, 2001, 274.

- e. **Pedestrian Crossings at Intersections.** Intersections of pedestrian facilities with public streets shall have crossings meeting the following standards.
1. Curb ramps meeting ADA accessibility standards shall provide a direct, non-diverted approach from the sidewalk along the block, into the pedestrian crossing area.
 2. Pedestrian crossings of collector streets or higher classification shall be considered for enhanced crossings, including crosswalks differentiated from the roadway surface, according to Appendix E, Pedestrian and Bicycle Guidelines, Sections E-6 through E-12. Crossing designs and locations are subject to approval of the Director and City Engineer.
 3. Where block faces exceed more than 800' between intersections, or at other locations of high pedestrian activity, mid-block crossings shall be considered according to Appendix E, Pedestrian and Bicycle Guidelines, Section E-8. Mid-block crossing designs and locations are subject to approval of the Director and City Engineer.
- f. **Transit Stops or Stations.** Existing and proposed transit routes shall be incorporated into intersection designs and served with local transit stops that include:
1. Bus pullouts on all arterials where existing or future bus stops are planned.
 2. Bus pullouts shall be located at the far side of a signalized intersection.
 3. Bus stops shall incorporate minimum transit standards of a bus stop sign and pad for stops with low projected use, the inclusion of a bench for moderate activity and a shelter for high activity areas.
 4. Developers may be required to construct pullouts and pads.
- a. **Access Permit Required.** All vehicle access points shall require a Right-of-Way and Access Permit. Applicants should consult with the City Engineer prior to submitting an application to consider the criteria of this Section. No person shall commence work on the construction, alteration, repair, or removal of any access point or approach, sidewalk, curb and gutter, or paving in the right-of-way without a permit. Permits shall be issued upon approval of the application by the City's Construction and Traffic Department. Access to state highways will be subject to the approval of the Wyoming Department of Transportation.
- b. **Restricted Access.** Direct access to lots and blocks from collector and arterial streets is restricted as specified in the technical criteria for each specific street type to maintain traffic flow. Access may also be restricted on pedestrian-oriented streets or residential streets with small, narrow lots to preserve pedestrian flow and streetscape design. Appropriate access design is highly dependent on the context, specific transportation goals, and site variables. The City Engineer shall approve the design, number, and location of access points.
- c. **Access Width.** Lot access width shall be limited based upon the lot frontages subject to the standards in Table 4-13. Standards for specific street classifications or street design types may supersede these general allowances.

4.3.6 Block and Lot Access

The standards in this sub-section apply to access to streets from lots, blocks or other development sites. These standards shall be implemented consistent with the Pedestrian and Bicycle Guidelines in Appendix E and any required Transportation Impact Study or Transportation Impact Analysis. Alternative standards that better meet the Intent of this Section may be required or approved based on a Transportation Impact Study or Transportation Impact Analysis, or through the Waiver process specified in Article 2.

TABLE 4-13: LOT ACCESS WIDTH

Lot Frontage	Maximum Access Width ¹	Approach (curved or flared)
< 36' Residential	No front access. Requires Alley access.	n/a
36' to 54' Residential	8.5' to 10' and requires shared access with adjacent lot(s)	5'
54' to 74' Residential	8.5' to 10'	5'
75' to 120' Residential	18'	3' to 5'
> 120' Residential	15% of lot frontage, but no more than 36'	3' to 5'
Commercial or Mixed-use	25% of lot frontage for a single lot, but the cumulative width of access points along a single block face may never be more than 15% of the entire block face. In addition, lot access shall be limited as follows: <ul style="list-style-type: none"> • 24' to 36' for two-way • 10' to 15' for one-way 	5' to 20'
Industrial	12' to 15' for one-way 40' to 50' for two-way	20' to 50'

¹ Maximum width shall be measured along the right-of-way at the lot frontage or at any crossing of pedestrian facilities in the right-of-way, and may allow additional approach width through flares or radii to permit adequate turning movements.

Where maximum access widths in Table 4-13 limit or prohibit individual lot access points, shared access easements, or rear and mid-block access alley easements shall be used. [See Design Standards in Article 6 for related lot access types and design standards and circulation requirement applicable to lots and private site design.] Where a Traffic Impact Study or Traffic Impact Assessment indicate traffic counts at the lot access that warrant wider access dimensions, these access points shall be designed as street intersections.

Residential lot access width within the LR and MR zoning districts for Detached Dwelling and Semi-attached lot types shall be limited to a maximum driveway width of up to 50% of the lot frontage and not more than 36' wide and a minimum separation from side lot lines greater than or equal to the side building setback as an alternative compliance for access width standards described in Table 4-13 with the following exceptions:

- Lots on cul-de-sacs within the LR and MR zoning districts are limited to 75% of the front lot line but no more than 36' wide and there is no side setback requirement
- Driveways may be constructed within the side setback when the driveway width is a maximum of 50% of the lot frontage and not more than 20-feet wide. When this exception is applied to Detached Dwelling lot types, the garage must either be facing the side lot line or be setback 10' behind the front building line.

- d. **Minimum Access Point Separation.** Lot access points shall be separated from other access points along a single block face and from the street edge of intersections as specified for each specific street design type in sub-section 4.3.4.c.

Where minimum access point separation distances according to these standards for any cross section limit or prohibit individual lot access points, shared access easements or rear and mid-block access alley easements shall be used. [See Design Standards in Article 6 for related lot access types and design standards and circulation requirement applicable to lots and private site design.]

- e. **Pedestrian Crossings at Access Points.** Where public sidewalks cross permitted vehicle access points, pedestrian crossings of access points shall emphasize and place priority on pedestrian access and safety by one of the following manners:

1. The material, layout and grade of the public sidewalk shall be continuous as it crosses the vehicle surface; or
2. Where the allowances for access point standards in this Section allow access points greater than 22' wide, a crosswalk differentiated from vehicle surfaces by different materials, texture or color, or a speed table may be used. Crosswalks across access points shall not exceed 33'. Where the allowances of access point standards in this Section allow access points greater than 33', curb projections or center pedestrian refuge islands shall be used to shorten pedestrian crossing distances of vehicle surfaces; or
3. Where high-speed or frequent vehicle access is expected (generally access points with anticipated ADT more than 500 vehicles) the City Engineer may allow vehicle lot access points at street grade, provided design standards for intersections of public streets in Section 4.3.5, including intersection design and pedestrian crossings, are used.

- f. **Changes or Abandonment.** If any significant changes are made in the use of property which will affect access operation, traffic volume, turning movements, or typical vehicle type, the permittee or property owner shall contact the City to determine if a new permit is necessary. If recorded in the Public Land Records, the terms and conditions of the permit are binding on all

assigns, successors-in-interest, heirs, and occupants. If a parcel of land with an access point has been in a state of non-use for more than four years, recommencement of access use shall be considered a change in use. If the renewed use of the access exceeds the design limitation or is non-conforming with the present code, a new permit shall be required. Unused and abandoned access points may be ordered to be closed upon direction of the City Engineer.

g. Additional Permit Criteria.

1. The access point approach surface should be paved with Portland cement concrete with a minimum depth of 6 inches for residential and 8 inches for commercial, and meeting any other City specifications. However, if the adjacent road has a gravel surface, the driveway approach, if not paved, shall have a minimum of six inches of crushed gravel. The access point approach may be asphalt for any driveways that cross borrow ditches.
2. The access point approach shall extend from the street edge to at least 20' or to the right-of-way line, whichever is greater. In the case of commercial or industrial access point approaches, permanent pavement is required for at least 50'.
3. Access points with high traffic volumes, such as fast food restaurants and car washes, shall make provisions for car storage on the premises to prevent stacking of vehicles on the roadway.
4. A permit shall not be issued for access to parking or loading areas that require backing maneuvers in a public street. Residential dwellings (detached, duplexes and townhomes) on local streets are an exception.
5. Sight distance requirements for street intersections may be applied to driveways where volumes and speed of traffic in the street and volumes for the access point warrant treating it as a street intersection.
6. Access points shall be located so as to minimize the hazards to pedestrians and vehicles.
7. Access points shall be located and constructed in a manner that does not damage existing facilities such as street lights, utilities, traffic control devices and signs, or fire hydrants. The applicant shall pay the cost of repair or relocating any such facility in association with the permit, and with authorization of a person with authority over the facility.

h. Exceptions. Where, due to pre-existing lot and street

configurations, application of these standards would lead to ineffective and inefficient lot access, the City Engineer may grant exceptions to the access requirements of sub-section 4.3.6 provided:

1. All alternative access strategies have been exhausted;
2. The street design and transportation network will not be adversely affected by the exception, and the proposed access is generally consistent with the Intent of this Section;
3. The proposed access is generally consistent with the Pedestrian and Bicycle Guidelines in Appendix E or those guidelines are otherwise determined to not be applicable to the specific site;
4. The proposed access is designed to provide the least possible impact on the public streetscape and transportation network; and
5. The proposed access has been reviewed and recommended by the City Engineer and Director.

4.3.7 Access Management for High-volume / High-speed Roadways

The following sub-sections apply to high-speed / high-volume roadways, which in general are roadways with over 10,000 Average Daily Trips or over 1,000 Peak Hour Trips, and which have design speeds over 35 miles per hour. Where necessary, for the safe and efficient movement of traffic, the City Engineer may require access points to provide for only limited turning movements and alter the street cross-sections and access standards otherwise provided in this Section 4.3. These standards shall be considered by the City Engineer in association with any Traffic Impact Study or Traffic Impact Analysis, and must be coordinated with any specific Transportation Network Plan and the Pedestrian and Bicycle Guidelines in Appendix E.

a. General Considerations. Generally access is dependent on a number of variables as presented in the following Figure 4-21,

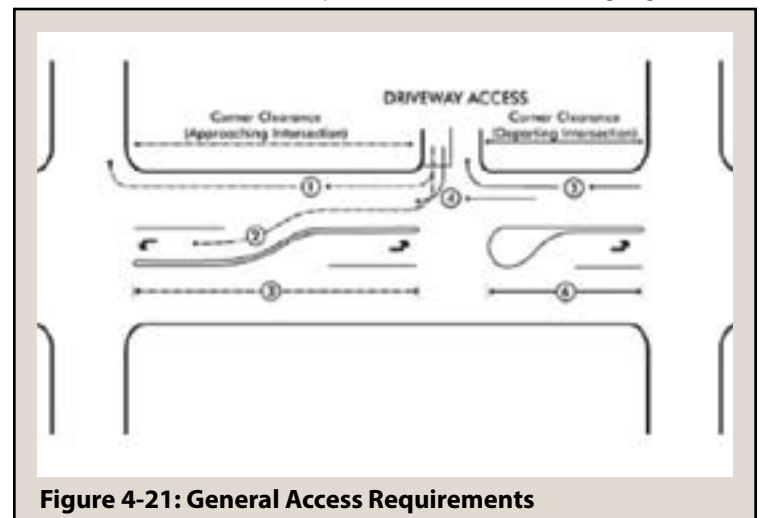

Figure 4-21: General Access Requirements

General Access Requirements. The following paragraphs correspond to numbers on Figure 4-21.

- (1) Right-turn driveway egress vehicles should not interfere with the right-turn queue at the downstream intersection (i.e., the driveway should be of sufficient distance back from the intersection so as not to interfere with the maximum right-turn queue as determined by a traffic study).
 - (2) Corner clearance should be of sufficient distance from the downstream intersection to allow right-turn egress sufficient distance to cross any right-turn and through travel lanes and enter the back of the left-turn pocket.
 - (3) If left-turn ingress and/or egress are to be provided, the minimum corner clearance should equal the length of the back-to-back left-turn pockets plus the bay taper (i.e., the minimum distance as measured from a crosswalk or stop bar for two 150' back-to-back left-turn lanes plus a 90' bay taper would be 390'. Ideally, this distance shall be approximately 600' to allow for extended left-turn lanes and a longer taper between left-turn pockets).
 - (4) Corner clearance from an upstream intersection should be of sufficient length to allow the exiting driver to determine whether an approaching vehicle will be traveling through the upstream intersection and to not interfere with the approaching vehicle. The corner clearance must be adequate to allow a vehicle approaching from the upstream intersection sufficient time to stop in the event that a vehicle at the access pulls out into the street.
 - (5) The corner distance should be of sufficient length to allow vehicles to make a right-turn into the access and not significantly impact the vehicles desiring to continue past the driveway.
 - (6) If left-turn egress is to be provided, the minimum corner clearance shall be the sum of the departing intersection left-turn pocket length and bay taper. (On major arterials, ideally this distance should be a minimum of 350')
- b. **Speed-change Lanes.**
1. *General Criteria.* Speed-change lanes shall be installed at access points according to the following criteria.
 - (a) A left-turn deceleration lane and taper with storage length is required for any access with a projected peak-hour ingress turning volume greater than 10 vehicles per hour. The taper length shall be included within the required deceleration length.
 - (b) A right-turn deceleration lane and taper is required for any access with a projected peak-hour ingress turning volume greater than 25 vehicles per hour. The taper length shall be included within the required deceleration length.
 - (c) A right-turn acceleration lane and taper is required for any access with a projected peak-hour right-turning volume greater than 50 vehicles per hour when the posted speed on the adjacent road or street is greater than 40 mph. The taper length will be included within the required acceleration length. A right-turn acceleration lane may also be required at signalized intersections if a free right-turn is needed to maintain an appropriate level of service.
 - (d) Right-turn deceleration and acceleration lanes are generally not required on roadways with three or more travel lanes in the direction of the right-turn.
 - (e) A left-turn acceleration lane with taper may be required when unique location factors such as highway speed and traffic density, access volume, the volume of commercial trucks, the influence of nearby access, existing highway auxiliary lanes close to the access, nearby traffic-control devices, available stopping sight distance, and where other topographic and highway design factors exist that determine the need. A left-turn acceleration lane is generally not required where the posted speed is less than 45 mph, or the intersection is signalized, or the acceleration lane would interfere with the left-turn ingress movements to any other access.
 2. *Lane Design Criteria.* Where speed-change lanes are required, they shall be constructed in accordance with the following:
 - (a) Where two accesses have speed-change lanes that overlap or are in close proximity, a continuous lane shall be established between the accesses to improve roadway consistency and safety and maintain edge continuity.
 - (b) Speed-change lanes shall be 12' wide, exclusive of the gutter pan or shoulder. If the existing through travel lanes are less than 12' wide, the speed change lanes may be the width of the widest through lane, but shall in no case be less than 10' wide, exclusive of the gutter pan or shoulder.
 - (c) Except for the driveway served, no other driveway access shall be permitted within the limits of the speed-change lanes.
 - (d) Acceleration lanes shall not conflict with the

- beginning of a right-turn lane.
- (e) Acceleration lanes shall terminate before the end of the queue (as determined by the traffic study) at a signalized intersection. Acceleration lanes shall terminate not less than 50' ahead of an un-signalized intersection. If adequate length of acceleration lane cannot be provided subject to these constraints, the access will not be permitted.
- (f) Table 4-14 shall be used to determine lengths of speed-change lanes. The required length of taper is obtained by multiplying the full lane width by the appropriate ratio as shown in Table 4-14. "Stop Condition" means the vehicle comes to a complete stop or very slow speed prior to making the turn into the access or is stopped before exiting the access onto the street. For deceleration lanes, a 15 mph turn is normally assumed for a curb return radius only if the radius is 40' or greater. A stop condition must be assumed for a curb-cut type access. For an acceleration lane, a stop condition shall normally be assumed at the start of the acceleration.
- (g) Additional storage lengths are required for left-turn deceleration lanes. Standards for the additional storage lengths are provided in Section 4.3.7.e.

- c. **Left-turn Bays and Spacing.** Driveways serving high-generation users such as community and regional shopping centers, large industrial plants, major office building complexes, and high-density apartment developments shall provide for adequate left-turn storage bays.
 1. *Signalized Intersections.* As a general guideline, the minimum left-turn lane length at signalized intersections shall be one foot of length for each p.m. peak-hour left-turning vehicle, forecasted for the 20-year horizon. The minimum left-turn bay shall be designed at 50' and increased in increments of 25'. When the projected left-turn length reaches 250' signal timing and progression analysis shall be conducted to determine if dual left-turn bays are required. No single left-turn lane shall exceed 350'.
 2. *Un-signalized Intersections.* The need for and length of left-turn storage bays for unsignalized intersections and driveways shall be determined according to Figure 4-22 and the highest predicted traffic volumes for the next 20 years. The provisions of this section will apply to any access location which requires left-turn storage bay of 50' or more as determined according to Figure 4-22. The requirement for left-turn bays will automatically establish a minimum spacing of successive driveways or intersections which are projected to have left-turn entry or exit access. The basic factors are the distance required for the median taper and the length of the storage bay. If a driveway on a major route is opposite a street, a left-turn bay for the street also should be incorporated. This will further increase the required distance between major driveway approaches or intersections. The distance of a major driveway with left-turn channelization from a nearby major intersection which also has left-turn bays will vary depending on whether the driveway is on the approach or departure side of the intersection with respect to the left-turn lane.

TABLE 4-14: SPEED-CHANGE LANE LENGTHS FOR RIGHT AND LEFT TURN LANES

Design Speed	Stop Condition		15 MPH Turn		Minimum Accel Lane Taper Ratio*	Minimum Decel Lane Taper Ratio*
	Accel	Decel	Accel	Decel		
35	270'	275'	240'	235'	12.5:1	10:1
40	380'	315'	320'	295'	15:1	11.5:1
45	550'	375'	480'	350'	15:1	13:1
50	760'	435'	480'	350'	15:1	13:1
55	960'	485'	480'	350'	15:1	13:1

* Ratio of length of taper to width of lane.

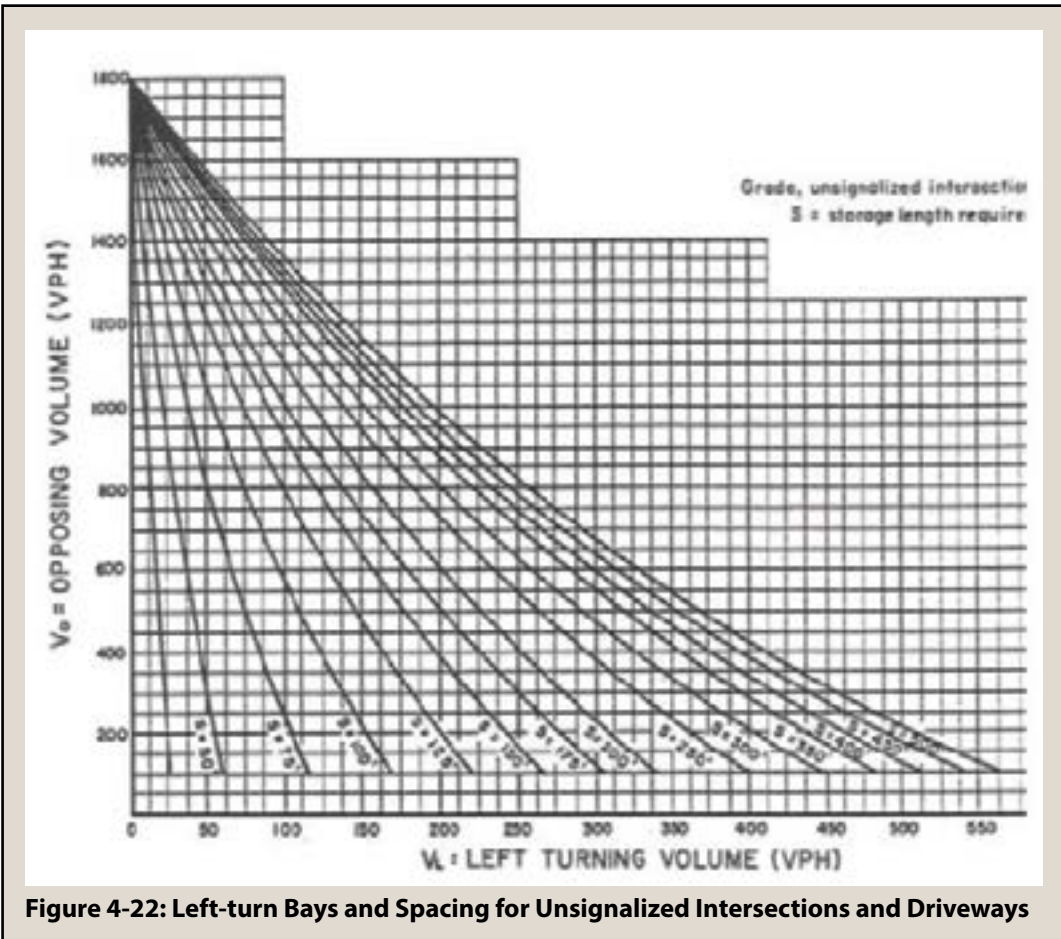

Figure 4-22: Left-turn Bays and Spacing for Unsignalized Intersections and Driveways

d. **Left Turn In / Out Access.** The ability to provide full or partial access along a street or highway shall be commensurate with the ability to safely guide vehicles in and out of the driveways through the highway stream, while maintaining acceptable levels of service. The safe operation of an un-signalized intersection is a function of the number of acceptable gaps in the through traffic stream based on 20-year peak-hour forecasts compared to the number of vehicles forecasted to turn left into or out of an access or driveway. Figures 4-23 and 4-24 provide the guidelines whether left-in only or left-in/left-out access will be considered along high-volume / high-speed roadways. The guideline is based on the volume of vehicles entering and/or exiting a driveway in relationship to the conflicting volumes along the roadway. Figure 4-23 depicts the relationship between the left-turn volume, LTV-1 for left-turn volumes in and LTV-O for the left-turn volumes out, and the sum of the conflicting volumes, V_c , for each scenario.

Figure 4-24 presents a graph in which the left-turn in and/or left-turn out is compared to its conflicting volume. The access is considered acceptable when the volumes lie below the intersection of the left turn volume and the sum of the conflicting volumes lie below the guideline. Access is not recommended when this point is above the line. This guideline should be used in conjunction with supporting *Highway Capacity Manual* un-signalized intersection level-of-service analysis. If left-turn access is proposed for a high-volume / high-speed roadway, an accident analysis may be required by the City Engineer.

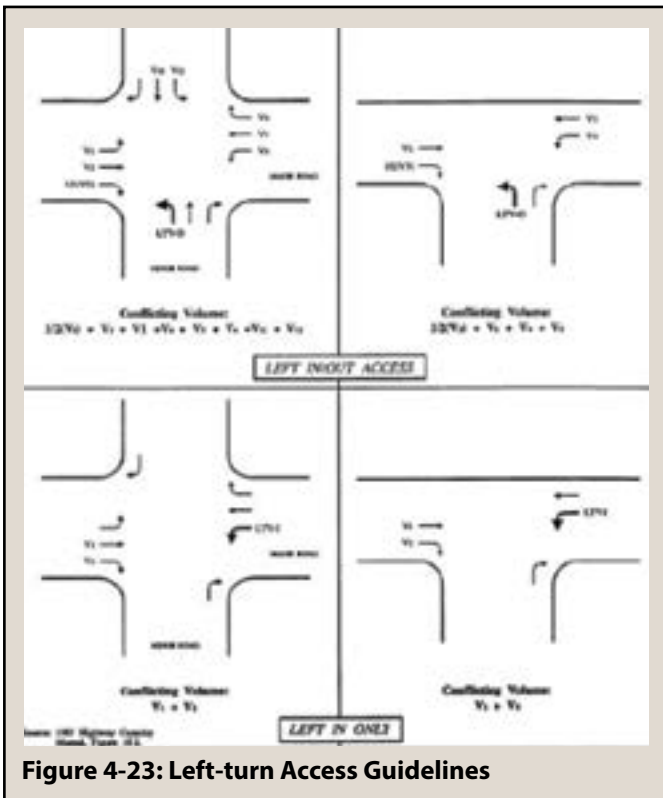

Figure 4-23: Left-turn Access Guidelines

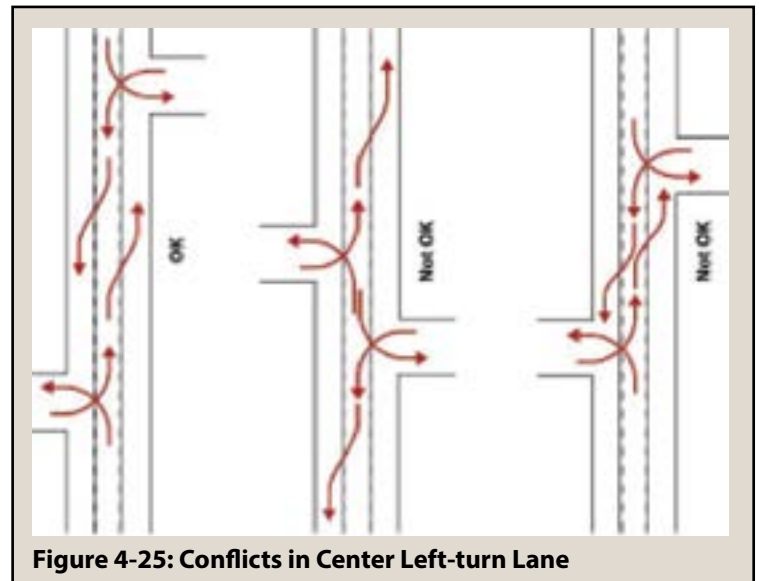

Figure 4-25: Conflicts in Center Left-turn Lane

- e. **Access Coordination.** The location of access to properties on opposite sides of arterial and collector roadways shall be coordinated so they do not interfere with one another. Driveway approaches directly opposite each other are desirable. However, if this is not possible, the resulting “T” configurations shall be spaced a minimum of 100’ apart on collectors, and 200’ apart on arterials. This requirement may be modified by the City Engineer based on existing through traffic and the trip generation of the site. When establishing the placement of offset accesses (either driveways or intersections), traffic making left-hand turns into the accesses shall not conflict or compete for the simultaneous use of a center left-turn lane as shown in Figure 4-25.

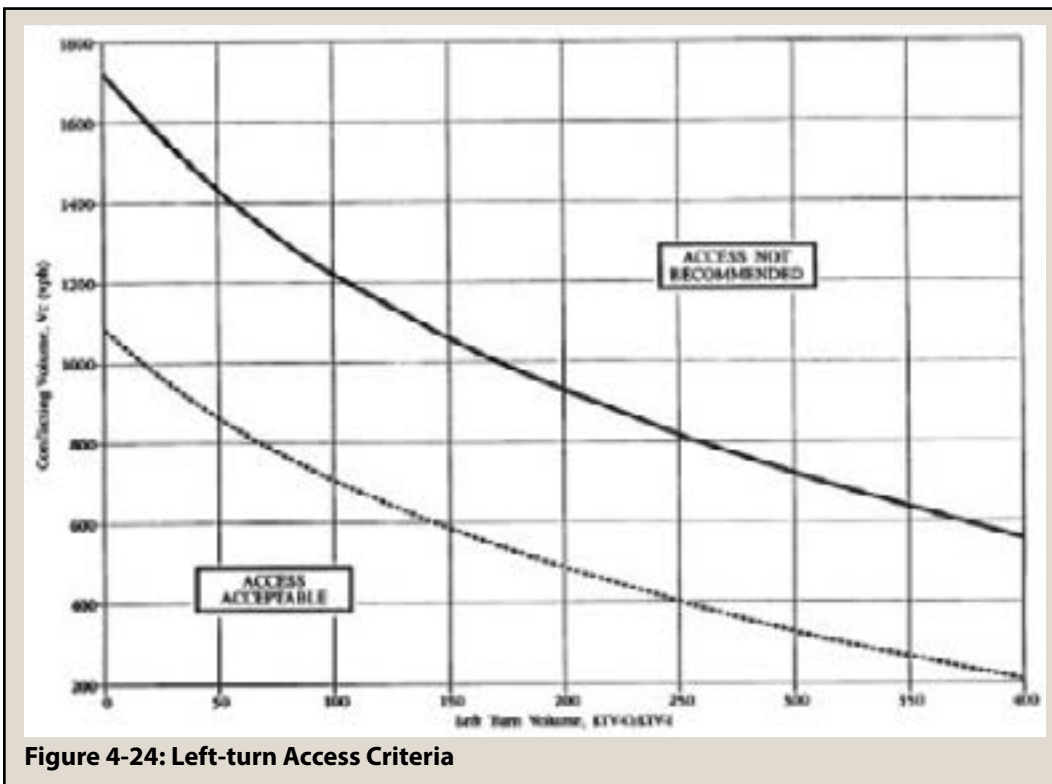

Figure 4-24: Left-turn Access Criteria

4.4 Open Space Systems

- 4.4.1 Intent
- 4.4.2 Applicability
- 4.4.3 Required Open Space Systems
- 4.4.4 Open Space Design Types
- 4.4.5 Location Criteria
- 4.4.6 Ownership and Management

4.4.1 Intent

It is the intent of this Section to:

- a. Value the design, function and appropriate application of different types of open space, rather than solely the quantity of space.
- b. Recognize open space, whether public, common, or private, as an important element of the civic infrastructure for the City and a primary determinant of community character.
- c. Consider the context and multiple functions that open spaces can serve to support development.
- d. Develop a greater perceived impact from open space by coordinating the design and location of open spaces among adjacent sites.
- e. Create meaningful connections between people and open space, and increase citizens' access to a wider variety of quality open spaces to meet recreation and social needs of the community.
- f. Relate constructed elements on streets, blocks, and lots to the open space and create focal points for the community, neighborhood, district, or development site.
- g. Integrate natural systems into the design of common or public open spaces to allow open space to serve multiple aesthetic, recreational, and ecological functions.

4.4.2 Applicability

- a. **General Applicability.** The Open Space requirement applies to all plat applications in order to designate areas of lots or parcels of land as non-buildable areas that will serve public or civic purposes that support the overall development pattern. In general it applies in addition to other setback and landscape provisions included in Articles 5 and 6 that may apply to developing private lots. However, effective development planning and site design can allow areas platted as part of the Open Space systems to meet both Article 4 and Article 5 or 6 requirements, as specifically provided in Article 5 or 6.

- b. **Exceptions.** The following are exceptions to the Open Space requirement in Table 4-15:

1. **Existing Public Open Space Credit.** Any proposed development lot within a ¼ mile buffer of any existing public open space used for parks and recreation purposes shall not be subject to the Open Space requirement provided the City determines that it is of sufficient capacity and design standard to serve the proposed development.
2. **Existing Shared Common Open Space Credit.** Any proposed development lot within the service areas specified in Table 4-16 for any existing common open space may receive a credit for this open space provided the City determines that it is of sufficient capacity and design standard to serve the proposed development. For the purpose of Natural Areas and Trails, the development lot must be within a 1000' buffer of an existing facility to receive this credit. The applicant shall also provide documentation granting legal access to this open space for future owners of the proposed subdivision.
3. **Residential Infill Development.** Residential infill parcels of less than 10 acres which are not within a ¼ mile buffer of existing public open space used for parks and recreation purposes shall not be subject to the Open Space Requirement where the City finds:
 - (a) Opportunities to incorporate open space meeting the design type and standards in Table 4-16 are limited due to the context and development patterns surrounding the property;
 - (b) Alternative site and development standards are proposed that provide future residents with sufficient open spaces or link proposed development to the overall pattern of any surrounding area, including relationships to other nearby open spaces; and
 - (c) The proposed development best meets the intent of this Section.
4. **Cash-in-Lieu of Open Space.** At the discretion of the City, an applicant may satisfy the Open Space requirement by making a cash payment to the City for an amount equal to the raw land value of the land required by Section 4.4.3.
 - (a) **Amount.** The raw land value of the required open space shall be established and agreed upon by the City and the applicant, prior to approval of the final plat. If the City and applicant are unable to agree upon the raw land value of the required open space, the value shall be established by

an independent appraiser. The independent appraiser shall be chosen by mutual agreement between the City and the applicant. The appraisal will be the raw land value of the entire proposed development area. The value of the required open space will be the same percentage of the appraisal amount as the percentage requirement in Table 4-15.

- (b) *Timing of Payment.* Payment shall be made to the City of Cheyenne prior to recordation of the Final Plat.
- (c) *Review Criteria.* The City shall consider the following criteria in evaluating a request for a cash-in-lieu payment:
 - (1) Whether the proposed development has practical options to meet the intent of Section 4.4 with open space within the proposed development;
 - (2) Whether the City has identified the applicant's proposed development site as being appropriate for parks, recreation, or open space according to official plans; and
 - (3) Whether reasonable alternatives may exist in the future for meeting open space requirements and intent of Section 4.4 by use of the cash-in-lieu on areas outside of the development.
- (d) *Use of Cash-in-Lieu.* Cash-in-lieu of open space requirements shall be held by the City and used for:
 - (1) Open space facilities that will serve the proposed development based on service

areas in Table 4-16. Additional distances may be justified in the discretion of the City based on context and circumstances. The funds may be used in addition to the Land Acquisition Fee, Infrastructure Fee, and Enhancement Fee required by Section 4.2 to make up for deficiencies of those fees for land acquisition, capital expenditures, or site design and development costs.

- (2) Regional parks or recreation facilities to the degree that the expenditure of the funds is proportional in total costs to the impact and need for the facility generated by the development. This may include land acquisition, capital expenditures, or site design and development costs.

4.4.3 Required Open Space

Minimum required Open Space shall be provided according to Table 4-15. No land shall be reserved by the applicant as non-buildable parcels or designated as open space unless it is of sufficient size, shape and topographically suitable to be of some practical use or service as part of a complete Open Space system that supports development. The City shall use the description, recommended size and applicability guidance in Table 4-16: Open Space Design Types and Standards and the Parks and Recreation Master Plan to make this determination. The required Open Space may be private, public or common ownership unless otherwise specified in these regulations.

Context / Development Pattern*	Applicable Zoning Districts*	Amount
<i>Agricultural and Rural</i>	AG, AR, RR	No requirement; EXCEPT that Open Space Subdivisions shall meet the open space policies of <i>PlanCheyenne</i> .
<i>Urban Transition Residential</i> <i>Urban Residential</i> <i>Mixed-Use Residential</i>	LR, MR, HR, NR-1, NR-2, NR-3, MUR	750 s.f. per dwelling unit or 8% of the gross area of the proposed development parcel, including lands to be platted as rights-of-way, whichever is less.
<i>Mixed-Use Commercial</i> <i>Mixed Use Employment</i> <i>Neighborhood Activity Centers</i> <i>Mixed-use Commercial Activity Centers</i> <i>Community / Regional Activity Center</i> <i>Central Business District</i> <i>Community Business</i>	MUB, MUE, NB, CB, CDB, PUD, P	2% of the building footprint for lots 2,500 square feet or less. 5% of building footprint for lots over 2,500 square feet and under 40,000 square feet. 8% of the building footprint for lots 40,000 square feet or more.

* Per *PlanCheyenne*. In cases where this table is used in association with site plan review, the applicable zoning district will control.

- a. **Amount.** The amount of open space required shall be based upon the context indicated in the Comprehensive Plan and as specified in Table 4-15.
- b. **Eligibility Exclusions.** In calculating the area of open space, the following shall be excluded from the open space:
 1. Any parking areas and vehicle access areas necessary to serve the Open Space, unless an approved porous surface is used.
 2. Any required rights-of-way, except that where additional civic amenities are provided in the right-of-way in addition to those specified in the typical street cross-sections of Section 4.3.4, and this area meets the design standards of Table 4-16, Open Space Types and Design Standards. The following provide examples of this provision:
 - (a) Where an Arterial street is platted with a Parkway design, and a 30' median is used instead of the 16' minimum required by Section 4.3.4, the additional area may count towards the Open Space requirement if it meets the general design and application provisions for a Trail Corridor in Table 4-16.
 - (b) Where a Minor Arterial street is platted with an Avenue or Street design type, and a 24' Sidewalk and Landscape area is provided along a building frontage instead of the 13' minimum required by Section 4.3.4, the additional area may count towards the open space requirement if it meets the general design and application provisions for a Plaza or Courtyard/Patio in Table 4-16.
 3. Storm water system facilities required by Section 4.5, except the following may be considered in the Open Space System:
 - (a) Areas for natural drainage systems used for storm water facilities may be included in Natural Areas, Trail Corridors, Parks or Greens which meet the Design Type and Standards in Table 4-16;
 - (b) Areas for retention designed and engineered as a permanent aesthetic and recreation amenity within one of the other open space types, and where the permanent surface water areas do not exceed 25% of the open space area; or
 - (c) Areas for detention designed and engineered to serve some other primary purpose as one of the Open Space types specified in this section, and the frequency and duration of standing water does not restrict the areas primary use on a regular basis.
 4. Utility easements required by Article 4.5, except where they are designed as one of the open space types specified in Table 4-16, and the easement acknowledges the design and use of the area as part of the Open Space System.
- c. **Weighting.** In order to recognize the value, context and function of well-designed open spaces, in addition to simply the amount of space, the actual land area designated as part of the open space shall be weighted by type. The weights associated with each type are designated in Table 4-16. Weights may be modified by Council when an open space proposal is of a particular high value to the community or in cases where additional amenities are provided to the community. The actual area of open space proposed in a plat or plan shall be multiplied times the proposed weight for that type of open space for purposes of calculating the amount required by Table 4-16.

4.4.4 Open Space Design Types

In meeting the requirements for Open Space System consistent with the intent of this section, open space shall be designed and located based upon the standards and guidance in Table 4-16:

TABLE 4-16: OPEN SPACE DESIGN TYPES AND STANDARDS

Type	Description	Recommended Size	Applicability
Natural Area	An undeveloped area that contains significant natural features or habitat worthy of preservation, and which provide environmental, aesthetic, and recreational benefits. Features such as large stands of trees, water elements, or prominent topography characterize Natural Areas. It contains little or no constructed improvements or maintained landscape other than trails to access the Natural Area.	The size of a Natural Area should be based on the site characteristics and potential continuity of similar natural features in the area, along with the potential to connect to adjacent natural areas, but generally contribute to an area of at least 10 contiguous acres.	<ul style="list-style-type: none"> Rural Residential areas Low-Density Residential areas Any other area of natural amenity with regional significance. <p>Service Area: N/A, dependant on area of contributing natural features.</p> <p>Weight Factor: 0.5</p>
Trail Corridor	An undeveloped area of continuous linear natural features, often following a stream, floodplain, or road corridor. A Trail Corridor should be usable for recreation and non-motorized transportation through pedestrian or multi-use trails. It includes few constructed improvements except for those to enhance travel or recreational use.	Trail Corridors should be at least 1 linear mile but sized and located based on opportunity to provide greater significant continuity throughout a development and to areas beyond the development area. Trail Corridors should be at least 30' wide at all locations, and wider where natural features warrant. Trail corridors may be narrower in more constrained or urban conditions.	<ul style="list-style-type: none"> Alternative (off-street) transportation routes between neighborhoods and centers Along major streets in the network as expanded ROW Used to preserve linear natural features in more densely developed Neighborhoods and Activity Centers. <p>Service Area: N/A, dependant on extent of linear features or associated major street plans. However to serve pedestrian interests, development served by trail corridors should be within 1000' of trail access points.</p> <p>Weight Factor: 0.9</p>
Park	A Park has a predominantly natural landscape although small portions may be designed and constructed for aesthetic purposes, formal gatherings, and structured recreation purposes. See Parks and Recreation Master Plan in <i>PlanCheyenne</i> and Parks and Recreation Design Standards.	<ul style="list-style-type: none"> 2-5 acres for Pocket Parks within neighborhoods and activity centers 5-20 acres for Neighborhood Parks 20+ acres for Community or Regional Parks 	<ul style="list-style-type: none"> Low-density Residential Urban Residential Neighborhoods Mixed-use Commercial Activity Centers Community / Regional Activity Centers Special Planning Districts <p>Service Area: Pocket Parks = 1000' Neighborhood Parks = ¼ mile Community Parks = 1 mile</p> <p>Weight Factor: 1.0</p>
Green	An open space for unstructured recreation or aesthetic landscaping. A Green is bordered by public rights-of-way or internal access ways on at least 2 sides. Front building facades and/or formal edge landscaped elements define any boundaries of the Green not bordered by public rights-of-way or internal access ways. Frontage on rights-of-way or internal access ways may be accommodated by pedestrian connections. Generally there are few constructed elements except for small gathering places created as a focal point for the Green.	½ acre to 3 acres	<ul style="list-style-type: none"> Urban Residential Neighborhoods All Activity Centers Special Planning Districts <p>Service Area: within two blocks and no more than 1000'.</p> <p>Weight Factor: 1.0</p>

TABLE 4-16: OPEN SPACE DESIGN TYPES AND STANDARDS

Type	Description	Recommended Size	Applicability
Plaza	An open space for civic purposes and formal gathering. Building facades define any boundaries of a Plaza not bordered by public rights-of-way or other active pedestrian corridors. In any case access shall be accommodated by at least two well defined and easily identified areas for public access. Plazas bordered by public right-of-way may accommodate one or both access areas. A Plaza is largely comprised of constructed materials to withstand heavy pedestrian traffic gathering, but contains intermittent lawns, landscape beds, or trees in a formal ornamental pattern.	500 square feet to ¼ acre	<ul style="list-style-type: none"> All Activity Centers Special Planning Districts <p>Service Area: within the same block or immediately adjacent block and no more than 600’.</p> <p>Weight Factor: 1.5</p>
Courtyard / Patio	A small open space accessible to the public streets but generally serving one or a few surrounding buildings. Courtyards are primarily bordered by building facades, but have at least one side fully or partially bordered by a public right-of-way. A Courtyard contains a balance of formal landscape features and constructed materials to withstand heavy pedestrian traffic and gathering.	400 square feet to 5000 square feet	<ul style="list-style-type: none"> Urban Residential Neighborhood All Activity Centers Special Planning Districts <p>Service Area: within the same block and no more than 300’.</p> <p>Weight Factor: 1.3</p>
Gateway	A small open space with pedestrian access used for aesthetic landscaping and small informal gathering. A Gateway includes identifying architectural or public art features to establish a sense of entry or arrival. Pocket Parks / Gateways are often designed within or in close association of the right-of-way to emphasize transitions along a corridor, at entrances to a neighborhood or district, or to create a focal point on a block.	200 square feet to ½ acre	<ul style="list-style-type: none"> Urban Residential Neighborhood (Limited to no more than 25% of the Civic Open Space requirement) All Activity Centers Special Planning Districts <p>Service Area: within the same block and no more than 300’.</p> <p>Weight Factor: 0.8</p>

4.4.5 Location Criteria

The following location criteria shall be used in determining the most appropriate locations and characteristics of land to be designated as required Open Space within subdivisions of land.

- a. Priority should be given to areas that provide the most visible impact.
 1. Formal open space (Greens, Plazas, Courtyards/ Patios, Pocket Parks/Gateways) should be located at prominent focal points within a subdivision or development site, and included in or designed as an effective extension of the public rights-of-way, or other common areas.
 2. Natural open space (Natural Areas, Trail Corridors, Parks) should be located along prominent ridges, valleys and view corridors.
- b. Open Space should be located to provide the greatest connectivity of open space systems with adjacent and future development sites.
 1. Formal open space (Greens, Plazas, Courtyards / Patios, Pocket Parks/Gateways) should be located according to an overall urban design theme for the area, considering where planned future transportation systems, block patterns, and key building and site entrances will be located for the site and for adjacent areas.
 2. Natural open spaces (Natural Areas, Trail Corridors, Parks) should be located in areas that have the greatest potential for future expansion and connectivity to land areas with similar physical features and ecological characteristics on adjacent sites.

- c. Open Space shall be located in areas that maximize its functional characteristics.
 - 1. Formal open space (Greens, Plazas, Courtyards / Patios, Pocket Parks/Gateways) shall be centered in areas that will have the greatest population density or development intensity in order to provide the greatest pedestrian accessibility possible.
 - 2. Natural open spaces (Natural Areas, Trail Corridors, Parks) shall be located in areas where the ecological, aesthetic, and recreational impact will be the greatest.

4.4.6 Ownership and Management

Required Open Space shall require specific designation on the final plat, including the ownership and management disposition. Options for ownership and management of preserved area include:

- a. Creation of or dedication to a non-profit entity capable of carrying out the ownership and management.
- b. Creation of a Homeowners and/or Leaseholders Association capable of carrying out the ownership and management.
- c. Private ownership provided the open space is platted as part of a defined lot in the subdivision, and includes covenants and other restrictions that will maintain the area as private open space.

All Open Space shall require documentation that demonstrates the ongoing maintenance and management of the space, including the administrative and financial means to provide maintenance and management. This documentation shall be included as part of the final plat application and recorded with the approved final plat. Dedication to the City or other public entity subject to acceptance by and at the sole discretion of the City or other public entity satisfies this requirement.

4.5 Required Improvements and Engineering Specifications

- 4.5.1 Intent
- 4.5.2 Street Specifications
- 4.5.3 Water and Sewerage
- 4.5.4 Utilities
- 4.5.5 Innovation, New Technology and Non-typical Design
- 4.5.6 Upsizing

4.5.1 Intent

It is the intent of this Section to:

- a. Coordinate the operation and function of infrastructure systems across several distinct and independent subdivisions of land.
- b. Ensure that the operation of infrastructure systems is compatible with the function and design of the system of streets, blocks, and lots.
- c. Allow for efficient development of land through the coordination of all infrastructure systems operating within the City.
- d. Ensure that necessary public improvements and infrastructure systems are available, or can be efficiently constructed and coordinated with future development.
- e. Provide all lots for potential development with adequate utility services.
- f. Facilitate coordinated and efficient construction of utilities for existing, immediate, and planned future growth, and minimize needs for disruption of services throughout the City.
- g. Promote the long-term efficacy, operational integrity, and maintenance of utility and public facility systems.
- h. Allow for construction and maintenance of utility and public facility systems that presents the least impact on other infrastructure systems, natural resources, and the aesthetics of the community.

4.5.2 Street Specifications

- a. **Pavement Design.** Pavement design shall be in accordance with AASHTO pavement design procedures (*AASHTO Guide for Design of Pavement Structures*, current edition) and shall be based on geotechnical investigations and

testing of the subgrade. The pavement design shall provide for a 20-year service life with an equivalent 18 kip axle loading based on projected traffic for the type and density of development proposed. Roadway construction plans submitted for approval shall be accompanied by a pavement-design report. Roadway sections and compaction requirements shall meet or exceed the requirements of the pavement design report and the City of Cheyenne and *Board of Public Utilities Construction Specifications and Standard Drawings*, whichever is more restrictive. The pavement-design report shall be prepared under the supervision of and signed and sealed by a person licensed by the Wyoming State Board of Registration for Professional Engineers and Professional Land Surveyors to practice civil engineering in Wyoming. Any proposed modifications to the approved design shall be submitted for approval. For street improvements of 250' or less, the minimum pavement sections may be used in lieu of a design report.

1. *Road Paving Policy.* All new highways, roads, and streets shall be paved.
2. *Pavement Design Report.* For all land development approvals that involve a roadway construction of 250' or more, the applicant must provide a preliminary subgrade investigation and pavement-design report that recommends typical pavement structural section based on the known site soil conditions and the valid Traffic Impact Study. The Pavement Design report shall use the Traffic Impact Study to determine equivalent daily load applications (EDLA) or equivalent single-axle loading (ESAL) for the pavements. However, if the EDLA or ESAL from the Traffic Impact Study are less than the EDLA or ESAL shown on Table 4-17, the EDLA or ESAL from Table 4-17 shall be used. For street improvements of 250' or less, the minimum pavement sections may be used in lieu of a design report.
3. *Minimum Pavement Section.* This paragraph provides the minimum acceptable pavement sections for public roadways in Cheyenne. These pavement thicknesses may be used for preliminary planning purposes. Final pavement designs must be based on actual subgrade support test results and the Traffic Impact Study. Table 4-17 lists minimum thicknesses for each roadway classification.

TABLE 4-17: MINIMUM PAVEMENT SECTIONS

Classification	EDLA	ESAL	Composite*		Full Depth Asphalt (Inches)	Portland Cement Concrete (Inches)
			Asphalt (inches)	Base (Inches)		
Principal Arterial	720.0	5,256,000	6.0	8.0	8.0	8.0
Minor Arterial	270.0	1,971,000	5.0	8.0	7.0	8.0
Non-Residential Collector	113.0	821,000	4.0	8.0	6.0	8.0
Residential Collector	113.0	821,000	4.0	8.0	6.0	8.0
Local	5.0	320,850	3.0	6.0	4.5	8.0
Paved Alley	5.0	292,000	3.0	6.0	4.5	8.0

*A composite section can only be used where the R-value of the subgrade soil is 30 or lower or the CBR value is 5 or lower.

- b. **Sidewalks.** The builder on the lot is responsible for sidewalk construction. Where sidewalks are not directly related to a lot, the construction of sidewalks is the responsibility of the developer. A certificate of occupancy will not be issued until sidewalks required by the approved site plan are constructed and approved. Sidewalk construction and removal shall be in accordance with the current *City of Cheyenne and Board of Public Utilities Construction Standards and Specifications*. Sidewalks shall be a minimum of 4 inches thick, except where traversed by driveways, in which case the driveway thickness shall govern.
- c. **Street Lighting.** The City of Cheyenne utilizes the current edition of *the American National Standard Practice for Roadway Lighting*, published by the Illuminating Engineering Society, as its standard for street lighting. The publication includes recommendations for average maintained horizontal illumination for roadway and walkway classifications by type of area. In addition, all street lighting shall meet the intent of any other City lighting standards in effect at the time.
- d. **Traffic Control Devices.** In a subdivision, the developer shall be responsible for the construction of traffic-control devices and street signs. When a development impacts a street or streets to the extent that a traffic signal or other traffic-control devices are necessary, the developer shall pay all or a proportionate share of the installation. Failure by the developer to pay his/her share may result in the City either limiting turning movements at the location to prevent unsafe movements from occurring or taking other actions to provide for safety at the location. The responsibility for traffic-control devices on State Highways is

indicated in the policies of the Wyoming DOT contained in the *MUTCD*.

1. To facilitate striping of new streets or re-striping of existing streets necessitated by a development, striping plans shall be submitted as part of the construction plans for approval. The striping plans shall utilize the lane widths and other requirements set forth in these Standards. In some cases these Standards do not require striping.
2. Traffic-control devices, including signs and pavement markings which are intended for the purpose of traffic control shall conform to the specifications of the *Manual on Uniform Traffic Control Devices*. No sign which in any way resembles or contains parts which resemble any traffic-control device shall be erected, altered, or maintained in any way for any purpose other than traffic control.
3. Stop or yield signs, warning signs, and advisory signs (as required by traffic volume) shall be installed as warranted in the *Manual on Uniform Traffic Control Devices*.
4. Street name signs shall be furnished and installed at all street intersections of the subdivision by the developer. The street name signs shall be designed and installed in compliance with the current *City of Cheyenne and Board of Public Utilities Construction Standards & Specifications*.
5. Street names which duplicate existing street names, or which are likely to be confused with existing street names, or which have difficult or exotic pronunciation shall not be used. Street names shall not consist of initials. Street names shall not contain symbols other than letters of the English alphabet and Arabic numerals. Street names shall be subject to the approval of the City Engineer. Street names in the City of Cheyenne shall also comply with *Cheyenne City Code*. Blank poles are prohibited.
6. Emergency access lanes are required for most large commercial and industrial land uses, and other facilities such as hospitals, schools, and large apartment buildings. Requirements for emergency access lanes are established by the Cheyenne Fire Department. When such lanes are provided, the developer is responsible for the installation and maintenance of the necessary signs and markings to delineate the lanes and prevent parking in them. Signs at spacings not more than 50' indicating "No Parking, Fire Lane" are required.

- e. **Driveway Approach Profiles.** Profiles shall be designed to permit entrance and exit maneuvers at safe speeds and provide sufficient underbody clearance for typical passenger cars. Driveway approach profiles shall be designed with the fewest and least severe grade changes possible.

1. Access approaches in urban areas shall be designed in accordance with the profile limits shown in Figure 4-26.

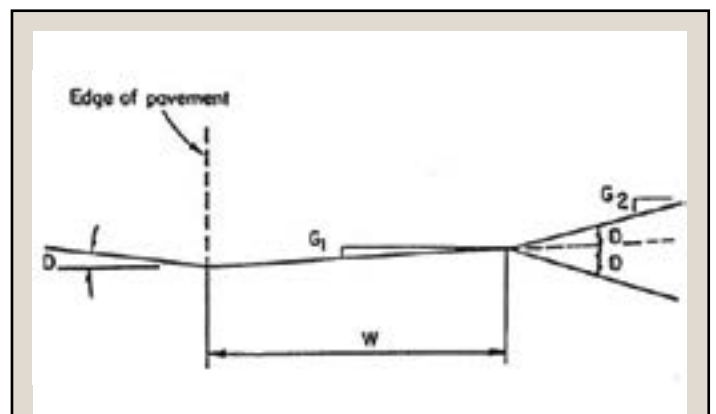

Figure 4-26: Driveway Profile Criteria

2. Profile criteria for various driveway and sidewalk crossings configurations are shown in Standard Drawings of the *City of Cheyenne and Board of Public Utilities Construction Standards and Specifications*. These standard drawings incorporate the slope criteria of the *Americans with Disabilities Act (ADA)*. These standard drawings are hereby adopted by reference into these Standards. They are available for public inspection at the City of Cheyenne Construction Department.

TABLE 4-18 - DRIVEWAY PROFILE STATISTICS						
Driveway Volume	Classification	Max G-1	Min G-1	Max G-2	Min W	Max D*
Low	Local	+ 4%	+ 2%	± 8%	Per 4.3.6	± 10%
Low	Arterial or Collector	+ 4%	+ 2%	± 8%	Per 4.3.6	± 6%
High	All	+ 4%	+ 2%	± 8%	Per 4.3.6	± 6%

* D is the grade change from G-1 to G-2.

Note: A driveway with peak-hour traffic volume of 30 or more is considered high volume.

ARTICLE 4 SUBDIVISION REGULATIONS

4.5 REQUIRED IMPROVEMENTS AND ENGINEERING SPECIFICATIONS

3. *Roadside Topography.* Access approaches shall be designed in accordance with the criteria and procedures described in the most recent release of the *Roadside Design Guide* by the American Association of State Highway and Transportation Officials.
4. *Driveway Approach Construction.*
 - (a) Approaches will be inspected prior to construction. The inspection will determine the proper size of the culvert, if applicable, and the approach grade.
 - (b) Culverts shall have flared end sections at each end.
 - (c) The driveway approach improvement shall extend at least 20' or to the right-of-way line, whichever is greater. In the case of commercial and industrial driveway approaches, permanent pavement is required for at least 50' from the edge of the roadway pavement.
 - (d) The distance from the right-of-way line to the near edge of service pumps, vendor stands, tanks, or private water hydrants shall be a minimum of 15' to permit free movement of large vehicles and to insure that they are entirely off the right-of-way when being serviced.
 - (e) Fixed obstructions shall not be placed within road right-of-way except for approved utility lines and mailbox assemblies or fencing at the right-of-way line. Approach culvert headwalls are prohibited.
 - (f) A complete design of the intersection shall be submitted to the City before a permit is issued.
 - (g) Except as indicated above, curb cuts and driveway approach aprons in the right-of-way shall be constructed of Portland cement concrete of a quality and type which is in accordance with specifications of the City of Cheyenne in effect at the time of such work. Curb cuts shall be permitted only with construction of adjoining Portland cement concrete aprons having a minimum depth of six inches for residential and eight inches for commercial developments.
5. *Reconstruction of Driveway Approaches.* Reconstruction of driveway approaches requires a permit as described in this article. Reconstructed driveway approaches shall conform to current regulations and the provisions of the *Americans with Disabilities Act*.
6. *Traffic Signals.* If the traffic study determines there is sufficient traffic (when the area is completely developed) to warrant installation of a traffic signal, traffic shall be consolidated to a single access which can be signalized. The signal shall meet traffic-signal spacing requirements as specified elsewhere in these Standards.
 - f. **Observation and Testing.** The developer or applicant is responsible for observations and testing performed on the roadway during construction. The observation and testing shall be done under the supervision of a qualified civil engineer who will signoff on the project. The testing shall be performed in accordance with the *City of Cheyenne and Board of Public Utilities Construction Standards & Specifications*.
 - g. **Record Drawings.** Record drawings shall be submitted in accordance with the *City of Cheyenne and Board of Public Utility Construction Standards and Specifications*. Record drawings are required for all roads, streets, storm sewer structures, detention facilities, and traffic signals. Upon completion and acceptance of construction, the developer shall provide record drawings to the City showing the as-constructed roads or streets. Record drawings are a requirement of acceptance. The record drawings shall be signed and sealed by a professional civil engineer and contain a statement to the effect that, to the best of the knowledge and belief of the engineer, the record drawings accurately reflect the as constructed facility. If the specifications were materially altered during construction, the submittal of the record drawings shall include revisions to the specifications. Submittal of record drawings or revised specifications does not relieve the developer from building the road or street in accordance with the approved plans. Deviations from the proposed plans and specifications shall be approved in advance by the City, and the developer assumes the risk of the expense of correcting unauthorized changes.
 - h. **Pre-Construction Conference.** A pre-construction conference shall be held with the Engineering and Construction Divisions of the City and Board of Public Utilities a minimum of two working days prior to any construction work (including water or sanitary sewer construction work.) The Contractor, Owner, Developer, Project Engineer, assigned City Inspector and assigned supervisory personnel shall attend this conference. A pre-construction meeting shall not be scheduled until construction plans have been approved by the City Engineer and Board of Public Utilities. A traffic control plan

shall be provided for City approval at this meeting.

- i. **Acceptance.** Upon completion of the road or street, the developer shall request in writing that the road be inspected for acceptance. This request shall include the surfacing material certification, tabulated record of surfacing material delivered to road and invoice of purchased surfacing material. This request shall be made to the City Engineer. The City Engineer will inspect the constructed road for compliance with these Standards. When the City Engineer determines that the road is in compliance, the road will be accepted for maintenance by the City. Note: The street is to remain the responsibility of the developer for maintenance and safety of the street until it is accepted.

4.5.3 Water and Sewerage

Public water and sanitary sewers including fire hydrants shall be designed and constructed in accordance with the City of Cheyenne and Board of Public Utilities Construction Standards and Specifications, current edition. Facilities shall also be built in accordance with the current Wyoming Department of Environmental Quality requirements for water and sewerage systems.

4.5.4 Utilities

Approval of any plat shall be contingent upon a demonstration of adequate utility systems. One factor which shall be considered is a statement from the appropriate utility company regarding the ability to provide services. All utilities including gas, electric, power, telecommunication, and cable shall be located underground and placed in the public right-of-way or alleys wherever possible. If placing the utilities in such locations is not practical or possible, or would require compromising the planning and community design standards of other sections in this Article, easements shall be provided for utilities. Landscape and utility plans shall be coordinated according to the Streetscape Design, Planning, and Maintenance Guidelines in Appendix G, Section G-4.

4.5.5 Innovation, New Technology and Non-typical Design

These Standards are based on current practice and technology. New developments in materials and methods will provide better and more economical designs and practices. Applicants and designers are encouraged to include innovative procedures, new materials, and improved design methods in

facility design. Proposals for innovations and new technology should, when appropriate, be submitted as requests for waivers as described in Article 2. Such requests should include as much documentation as possible of the proposed innovations—including reports of tests, documentation of successful use in other jurisdictions, calculations, publications, and any other information that will assist the City Engineer to determine if the proposal should be adopted.

4.5.6 Upsizing

Whenever any portions of the required public improvements are part of a planned future facility for the City, serving an area larger than the subdivision and its impact, the City and applicant will enter into an upsizing agreement. The City and the applicant shall negotiate the following aspects of the agreement prior to approval of the plat:

- a. The applicant shall construct the facilities as planned by the City for future capacity as part of the subdivision and development process.
- b. The applicant shall be responsible for the portion of the costs required to serve the proposed subdivision based on actual total cost to build the facilities absent any upsizing agreement.
- c. The City shall be responsible for any incremental costs to expand the facility to the planned capacity, beyond the capacity to serve the subdivision. The City's participation may be based by the applicant bidding the project with bid alternates, one alternate to build the minimum required facility to serve the subdivision or development and the second bid alternate being for the upsized facility planned by the City.
- d. The agreement shall be subject to approval by the City Attorney.

4.6 Public Safety Fees

- 4.6.1 Intent
- 4.6.2 Applicability
- 4.6.3 Fees

4.6.1 Intent

It is the Intent of this Section to:

- a. Anticipate and evaluate the incremental and long-term impact of development on broader public and community public safety facility needs.
- b. Identify opportunities to provide public safety services to new development.
- c. Collect fees for the roughly proportional and reasonably related impact of development on the ability to provide adequate public safety.

4.6.2 Applicability

a. General Applicability.

Public Safety fees shall be required for:

- 1. All new construction of the types listed in UDC 4.6.3.
- 2. Additions to existing non-residential increasing a building's square footage by 20% or more. In the case of additions to existing nonresidential buildings, fees shall only apply to the additional square footage added to the existing building.
- 3. Establishment of residential use within a previous non-residential structure.

b. Exceptions.

The following are exceptions to the fee requirement:

- 1. Reconstruction of an existing structure within 12 months of the structure's destruction, either purposefully, by natural disaster, or catastrophe, provided there is no increase in density or square footage. The Director may issue, for good cause shown, a one-time extension not to exceed twelve (12) months.
- 2. Interior building permits when there is no increase, or less than a 20% increase, in building square footage and the building is not being converted from a non-residential use to a residential use.

4.6.3 Fees.

The following fees are hereby established as shown in Table 4-19.

TABLE 4-19 - PUBLIC SAFETY IMPACT FEES		
Residential Uses	\$836.88	per unit
Commercial and Service Use	\$531.92	per 1,000 feet of finished floor area
Industrial Uses	\$457.18	per 1,000 feet of finished floor area
Civic and Public Service Uses	\$260.05	per 1,000 feet of finished floor area
Employment, Agriculture, and any Other Uses	\$882.98	per 1,000 feet of finished floor area

- a. **Annual Adjustment.** The fees identified in Table 4-19 shall be adjusted annually in January for inflation utilizing the construction cost index for twenty (20) cities, as issued by the current Engineering News Record. The City shall make these fees available on their City website.
- b. **Calculation and Time of Payment.** Fees shall be calculated per Table 4-19, and subsequent adjustments, and are due at the time of building permit application.
- c. **Limitations of Use.** The Public Safety Fees collected in accordance with the provisions of the is chapter shall be segregated for the purpose of public safety and related infrastructure.
- d. **Public Reporting and Accountability.** At the third regularly scheduled City Council meeting after the end of each fiscal year the City shall present a written report to the City Council with information detailing the balance in the fee account as of June 30th of each and year, fee rates, the source of funds by development type, and any specific projects funded by the account.

ARTICLE 5 ZONING REGULATIONS

5

Article 5, Zoning Regulations provided standards for kinds and classes of buildings and use of sites and buildings within zoning districts. It addresses issues of compatibility among types of uses, scale of uses and buildings within and between different zoning districts. It is most useful to landowners, developers pursuing individual projects and public officials reviewing projects for consistency with standards and impacts on adjacent areas.

UNIFIED DEVELOPMENT CODE

ARTICLE 5 ZONING REGULATIONS

- 5.1 General Provisions
- 5.2 Rural and Agriculture Districts Standards
- 5.3 Residential Neighborhood Districts Standards
- 5.4 Commercial and Mixed-Use Districts Standards
- 5.5 Industrial Districts Standards
- 5.6 Special Purpose and Overlay Districts Standards
- 5.7 Specific Use Standards
- 5.8 Supplemental Provisions

5.1 GENERAL PROVISIONS

- 5.1.1 Purpose
- 5.1.2 Zoning Districts Established
- 5.1.3 Official Zoning Map
- 5.1.4 Districts and Uses
- 5.1.5 Residential Building and Lot Types

5.1.1 Purpose

The purpose of this Article is to:

- a. Establish districts to regulate and restrict the erection, construction, reconstruction, alteration, repair, or use of buildings, structures or land.
- b. Develop standards for various classes or kinds of buildings permitted within each district, including scale, mass and orientation to lots and streets.
- c. Develop standards to ensure the compatibility of building types and permitted uses within districts consistent with the character of the district and its particular suitability for particular uses.
- d. Develop standards to ensure the compatibility and transitions between different districts, and to ensure the compatibility and transitions with public areas and development patterns established in Article 4, Subdivision Regulations.

- e. Ensure that all standards are in accordance with the Comprehensive Plan of the City, or any official specific area plan or program adopted under the Comprehensive Plan.

5.1.2 Zoning Districts Established

The following zoning districts are established:

Rural and Agriculture Districts	
AG	Agricultural
AR	Agricultural Residential
RR	Rural Residential
Residential Neighborhood Districts	
LR	Low-density Residential
MR	Medium-density Residential
HR	High-density Residential
NR-1	Neighborhood Residential - Moderate Density
NR-2	Neighborhood Residential – Medium Density
NR-3	Neighborhood Residential – High Density
Commercial and Mixed-Use districts	
NB	Neighborhood Business
CB	Community Business
CBD	Central Business District
MUR	Mixed-Use Residential Emphasis
MUB	Mixed-Use Business Emphasis
MUE	Mixed-Use Employment Emphasis
BP	Business Park
Industrial Districts	
LI	Light Industrial
HI	Heavy Industrial
Special Purpose and Overlay Districts	
P	Public District
PUD	Planned Unit Development
AD	Airport District
SS	Support Services
M	Military
AHR	Airport Height and Use Restrictions
CHR	State Capitol Height Restrictions

Form-based Code Districts*	
T-1	Natural
T-2	Rural
T-3	Suburban
T-4	General Urban
T-5	Urban Center
T-6	Urban Core
D	District
CS	Civic Space

* Form-based code districts are subject to a Regulating Plan, and the procedures and district standards in Article 7. Each district may further be limited with respect to uses by L (limited), R (restricted), and O (open) based on a specific Regulating Plan.

need to work closely together in determining the appropriate category for a specific use.

Uses are allowed in various zoning districts as either “permitted by right” (P), “permitted after administrative review” (A), or “permitted after conditional discretionary review” (C), as indicated in Table 5-1. The procedures and general criteria for these reviews are included in Article 2.

5.1.3 Official Zoning Map

The boundaries of the zoning districts in the City are established as shown on a map entitled City of Cheyenne zoning map. The City of Cheyenne zoning map is on file and maintained at the office of the City Engineer. The City of Cheyenne zoning map will bear the signature of the City Engineer, and will be updated in accordance with such zoning ordinance amendments as may be enacted from time to time by the governing body. The City of Cheyenne zoning map, as amended, together with the most recently adopted edition of the FEMA flood insurance rate map, including the designation of zoning districts are incorporated in this code. Copies of the map are on file at the office of the City Clerk and development office. Any conflict among the maps shall be resolved in favor of the most recent update on file at the office of the City Engineer. Any conflicts between the FEMA flood insurance rate maps and the City or County zoning maps shall be resolved in favor of the FEMA flood insurance rate maps.

5.1.4 Districts and Uses

Uses have been grouped in general categories, wherever possible. The categories are meant to allow discretion in determining permitted uses. Some uses are more specifically listed because of anticipated impacts associated with the use which warrant special treatment with respect to which district they are allowed in or special review procedures and standards that make the use compatible with certain districts. These cannot be included in the general categories and they require the approval process as indicated. Applicants and staff will

ARTICLE 5 ZONING REGULATIONS

5.1 GENERAL PROVISIONS

TABLE 5-1: ZONING DISTRICT USES

ZONING DISTRICTS ▶	AG	AR	RR	LR	MR	HR	NR-1	NR-2	NR-3	NB	CB	CBD	LI	HI	P	MUR	MUB	MUE	BP	AD	SS	PUD	M	AHR	CHR
▼ CATEGORY OF USES / SPECIFIC USES																									
Residential Uses																									
<i>Detached Dwelling</i>	P	P	P	P	P	P	P	P	P			P				P	P					P			
<i>Semi-attached Dwelling ("Duplex")</i>				P	P	P	P	P	P			P				P	P					P			
<i>Attached Dwelling ("Townhouse")</i>					P	P		P	P			P				P	P					P			
<i>Cottage Lots</i>				C	C	C	C	P	P			P				P	P					P			
<i>Group Housing</i>				C	C	C	C	C	C	C	C	C	C	C		C	C	C				P			
<i>Dormitories</i>					C	A						P				P	P					P			
<i>Multi-dwelling Building ("Apartment")</i>					C	P		P/C	P		C					P/C	P	P				P			
<i>Live/Work</i>					C	P		C	A	P	P	P				P	P	P	C			P			
<i>Mixed-use Dwelling</i>										P	P	P				P	P	P	C			P			
<i>Accessory Dwelling</i>	A	A	A	A	A	A	A	A	A			A				A	A					P			
<i>Urban Loft Building</i>									C	P	C	C				C	P					P			
<i>Manufactured housing parks</i>		C		C	C	C																P			
Civic Uses																									
<i>Neighborhood Assembly (<350 maximum occupancy)</i>	C	C	C	C	C	C	A	A	A	A	A	P	C		C	A	A	A	C			P			
<i>Community Assembly (350 - 1000 maximum occupancy)</i>											A	A	P	C		C	A	A	A	C		P			
<i>Cemeteries</i>	A										A	A	P	C		C	A	A	A			P			
<i>Primary and secondary schools</i>	C	C	C	C	C	C	C	C	C	C	A	A	P			P	A	A	A	C		P			
<i>Educational facilities</i>												P	P			P		A	A	C		P			
<i>Community Athletic Field</i>				C	C	C	C	C	C	A	A					P	A	A	A	P		P			
<i>Developed Athletic Field or Stadium</i>												C		C		C		C	C	P		P			
Service Uses																									
<i>Service Business - Limited</i>											P	P	P				A	P	P	P		P			
<i>Service Business - General</i>											C	P	P				C	C		P		P			
<i>Assisted Living / Nursing Home</i>	C	C	C	C	C	A	C	C	C	C	C					P	P	P	P			P			
<i>Animal Care - Kennel</i>	P	C									P		P							P		P			
<i>Animal Care - Hospital / Clinic</i>	C	C									C	P	C					C				P			
<i>Family Child Care Home (FCCH)</i>	P	P	P	P	P	P	P	P	P	P	P	P					P	P	P			P			
<i>Family Child Care Center (FC3C)</i>	A	A	A	A	A	A	A	A	A	A	P	P	P				A	P	P			P			
<i>Child Care Center (CCC)</i>	A	C	A	C	C	C	C	C	C	C	P	P	P				C	P	P	P		P			
<i>Emergency Shelter</i>												P		C											
<i>Entertainment, Indoor Recreation Facility</i>				C	C	C	C	C	C	C	P	P	P			A	C	P	P	P		P			

Planned District - uses subject to a development plan
 Federal Property - No City authority over uses
 Overlay District - uses subject to base zoning district
 Overlay District - uses subject to base zoning district

P = Use permitted by right A = use permitted after administrative review C = Use permitted after conditional discretionary review
 (blank = prohibited use)

ARTICLE 5

ZONING REGULATIONS

5.1 GENERAL PROVISIONS

TABLE 5-1: ZONING DISTRICT USES

ZONING DISTRICTS ►	AG	AR	RR	LR	MR	HR	NR-1	NR-2	NR-3	NB	CB	CBD	LI	HI	P	MUR	MUB	MUE	BP	AD	SS	PUD	M	AHR	CHR
▼ CATEGORY OF USES / SPECIFIC USES																									
Services Uses (cont.)																									
<i>Entertainment, Outdoor Recreation Facility</i>	C	C	C	C	C	C	C	C	C	C	C	A	C	C	A	C	C	C	P			P			
<i>Entertainment, Venue (1000+ maximum occupancy)</i>	C	C	C								A	A	C		A		C	C	P			P			
<i>Entertainment, Amusement, Recreation—Other</i>	C	C	C								C	P	C	C	C		C	C	C			P			
<i>Lodging, Bed and Breakfast</i>	P	A	A	C	C	C	C	A	P							P	P	P				P			
<i>Lodging, Hotel / Motel</i>											P	P					P	P	P			P			
<i>Medical Care, Clinic and Office</i>											P	P	P			C	P	P	P			P			
<i>Medical Care, Hospital</i>															P			P	P			P			
<i>Mini Storage</i>					C	C					P	C	P	P		C	C	P							
<i>Storage, Yard</i>													C	P					C			P			
Employment Uses																									P
<i>Home occupations</i>	P	P	P	P	P	P	P	P	P	P	P	P	P	P		P	P	P	P			P			
<i>Office – Limited (<3,500)</i>					C	A		C	A	P	P	P	P	P		P	P	P	P			P			
<i>Office – general (3,500 – 20K)</i>						C				C	P	P	P	P		A	P	P	P			P			
<i>Office – Major Office Complex (>20K)</i>											P	P	P	P			P	P	P			P			
Commercial Uses																									
<i>Convenience Retail / Corner Store (<2k)</i>											P	P	P	P		A	P	P	P			P			
<i>Neighborhood Retail (2K - 5K)</i>											P	P	P	P		A	P	P	P			P			
<i>General Retail (5K - 25K)</i>												P	P	P			P	A	P			P			
<i>Large-scale Retail (25K - 100K)</i>												P	P	P			P	C	P			P			
<i>Warehouse Retail (> 100K)</i>												P	P	P			P		P			P			
<i>Grocery Store <45K</i>											P	P	P	P			P	P	P			P			
<i>Supermarket > 45K</i>												P	P	P			P	C	P			P			
<i>Outdoor Sales, Limited</i>											A	P	A			A	A	A	C			P			
<i>Outdoor Sales, Seasonal</i>											C	A	C			C	C	C	C			P			
<i>Outdoor Sales, Event or Display Area</i>											C	A	C			C	C	C	C			P			
<i>Outdoor Sales</i>												C	C	C			C		C			P			
<i>Bars and liquor stores</i>											C	C	P		A		C	C		P		P			
<i>Automobile Service Repair</i>											C	P	C	P	P		C	C	P			P			
<i>Automobile Service Station - Limited</i>											C	P	C	P	P		C	C	P	P		P			
<i>Automobile Service Station - General</i>												P	C	P	P			C	P			P			
<i>Automobile Service Station – Large-scale</i>												C	C	P					P			P			

Planned District - uses subject to a development plan
 Federal Property - No City authority over uses
 Overlay District - uses subject to base zoning district
 Overlay District - uses subject to base zoning district

ARTICLE 5

ZONING REGULATIONS

5.1 GENERAL PROVISIONS

TABLE 5-1: ZONING DISTRICT USES

ZONING DISTRICTS ►	AG	AR	RR	LR	MR	HR	NR-1	NR-2	NR-3	NB	CB	CBD	LI	HI	P	MUR	MUB	MUE	BP	AD	SS	PUD	M	AHR	CHR
▼ CATEGORY OF USES / SPECIFIC USES																									
Commercial Uses (cont.)																									
<i>Food Service – Limited (under 2K)</i>										P	P	P				P	P	P	P	P	P				
<i>Food Service – General (2K – 4K)</i>										C	P	P					P	P	P	P	P				
<i>Food Service – Large-scale (over 4k)</i>											P	P					P	P	P			P			
Industrial Uses																									
<i>Data Center</i>										C	C	C	P	P			C	P	P						
<i>Limited Industrial</i>										A	A	P	P	P	P	A	P	P	P			P			
<i>Moderate Industrial</i>												C	P	P			C	P	P			P			
<i>General Industrial</i>													C	P						P		C			
<i>Industrial</i>														C						C		C			
<i>Limited Outdoor Storage</i>													P	P	C			A	P			C			
<i>Outdoor Storage</i>													C	P				C				C			
<i>Impoundment Yards</i>													P	P			C	C				C			
<i>Salvage yards</i>													C	C								C			
<i>Junk yards</i>														C								C			
<i>Air cargo terminals</i>																					P	C			
<i>Aircraft sales, repair, service, storage and relating uses</i>																					P	C			
<i>Railroad yards and maintenance buildings</i>													P	P					P			C			
Public Service Uses																									
<i>Commercial and Public Parking Facility</i>												P			P		P	P	P			P			
<i>Government Facility</i>										P	P	P	P	P	P	P	P	P	P	P	P	P			
<i>Military</i>																					P	P			
<i>Recycling Services</i>											C		P	P			C	C	C			P			
<i>Transportation facilities</i>											C		P	P	P					P	P	P			
<i>Utility Stations</i>	A	A	A	A	A	A	A	A	A	A	A	A	A	A	A	A	A	A	A	P	A	P			
Agriculture Uses																									
<i>General Agriculture</i>	P																					P	P		
<i>Limited Agriculture</i>	P	P																				P	P		
<i>Agricultural equipment or product sales</i>	C																					P			
<i>Commercial stables, arenas, and show barns</i>	C	C																				P			
<i>Nurseries, landscaping</i>	P	P									C		P	P			C					P			

Planned District - uses subject to a development plan
 Federal Property - No City authority over uses
 Overlay District - uses subject to base zoning district
 Overlay District - uses subject to base zoning district

ARTICLE 5

ZONING REGULATIONS

5.1 GENERAL PROVISIONS

5.1.5 Residential Building and Lot Types

The following residential lot types and building standards are enabled in the various residential zoning districts. Table 5-2 establishes the range of lot and building types enabled in each of the Residential Zoning Districts. All uses of land and buildings that are enabled by Table 5-1 shall meet the Lot and Building Type standards enabled for the particular zoning district.

a. Detached Dwelling (“Single-family”) Lot Types and Building Standards.

TYPE DD1: DETACHED DWELLING / AGRICULTURE LOT		
Lot Area (min.)		20 acres
Lot Frontage (min.)		300'
Setbacks: Principal Building (min.)	Front	25'
	Side	25'
	Rear	25'
Setbacks: Accessory Building (min.)	Front	Behind front building line
	Side	25'
	Rear	25'
Total Lot Coverage (max.)		n/a
Building Height (max.)	Principal	Up to three (3) stories
	Accessory	20' residential 50' agriculture
Zoning Districts		Permitted: AG, AR

TYPE DD2: DETACHED DWELLING / RURAL LOT		
Lot Area (min.)		5 acres
Lot Frontage (min.)		300'
Setbacks: Principal Building (min.)	Front	25'
	Side	25'
	Rear	25'
Setbacks: Accessory Building (min.)	Front	Behind front building line
	Side	25'
	Rear	25'
Total Lot Coverage (max.)		n/a
Building Height (max.)	Principal	Up to three (3) stories
	Accessory	20' residential 50' agriculture
Zoning Districts		Permitted: AR, RR

ARTICLE 5 ZONING REGULATIONS

5.1 GENERAL PROVISIONS

TYPE DD3: DETACHED DWELLING / LARGE LOT

Lot Area (min.)		1.5 acres
Lot Frontage (min.)		180'
Setbacks: Principal Building (min.)	Front	50'
	Side	50'
	Rear	50'
Setbacks: Accessory Building (min.)	Front	10' behind front building line
	Side	10' 25' on street side corner lots
	Rear	10'
Total Lot Coverage (max.)		40%
Building Height (max.)	Principal	Up to three (3) stories
	Accessory	In no case higher than the principal building
Zoning Districts	Permitted: AR, RR, LR	

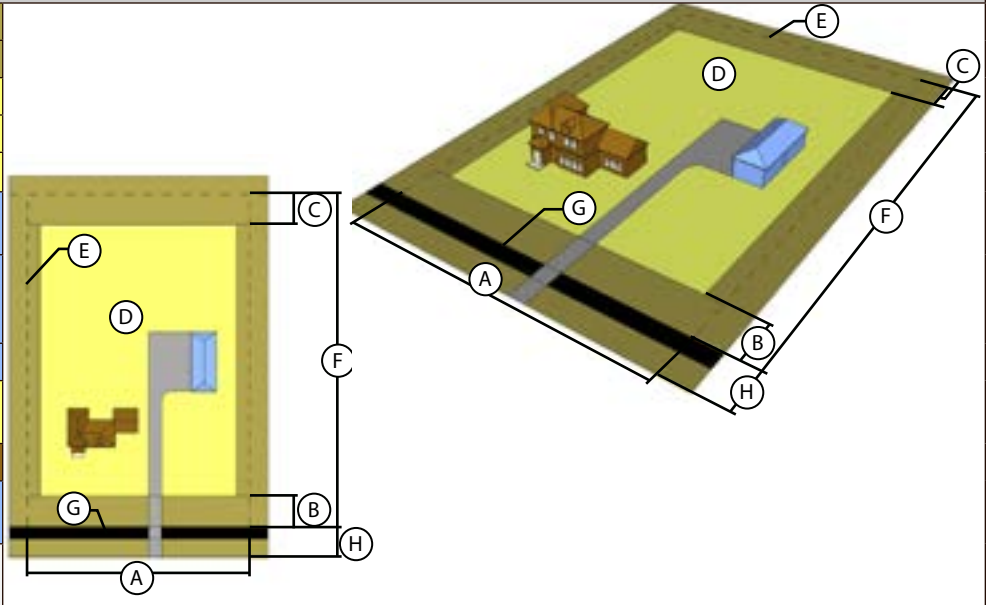

TYPE DD4: DETACHED DWELLING / LOW-DENSITY LOT

Lot Area (min.)		.5 acres
Lot Frontage (min.)		100'
Setbacks: Principal Building (min.)	Front	25'
	Side	10'
	Rear	25'
Setbacks: Accessory Building (min.)	Front	10' behind front building line
	Side	10' 25' on street side corner lots
	Rear	25'
Total Lot Coverage (max.)		40%
Building Height (max.)	Principal	Up to three (3) stories
	Accessory	In no case higher than the principal building
Zoning Districts	Permitted: AR, LR, NR-1	

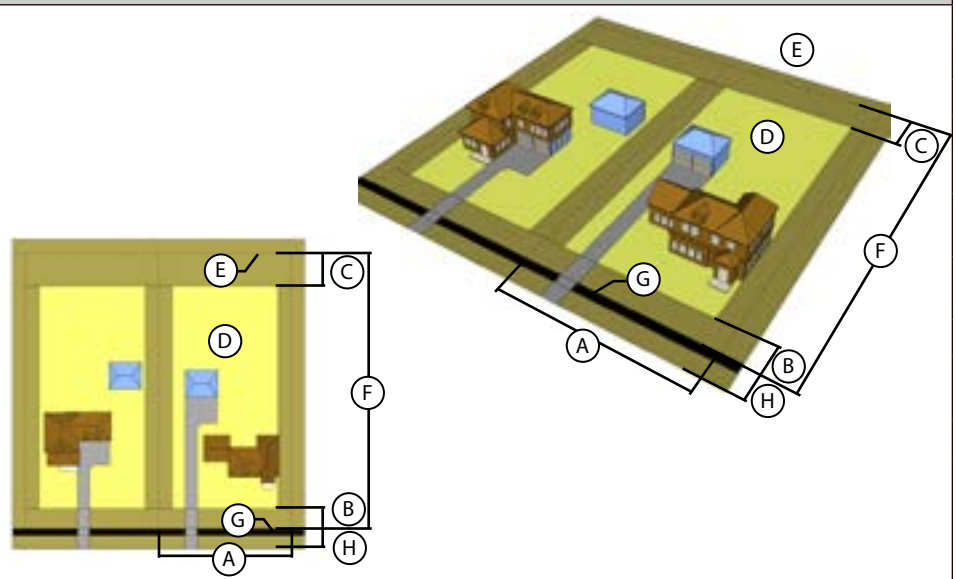

- | | |
|------------------------|-------------------------|
| (A) Frontage | (E) Property Boundary |
| (B) Front Setback | (F) Depth |
| (C) Rear Setback | (G) Public Sidewalk |
| (D) Buildable Lot Area | (H) Public Right-of-way |

ARTICLE 5

ZONING REGULATIONS

5.1 GENERAL PROVISIONS

TYPE DD5: DETACHED DWELLING / SUBURBAN LOT

Lot Frontage (min.)		70'
Setbacks: Principal Building (min.)	Front	25'
	Side	7.5'
	Rear	20'
Setbacks: Accessory Building (min.)	Front	10' behind front building line
	Side	7.5'
	Rear	5'
Total Lot Coverage (max.)		60%
Building Height (max.)	Principal	Up to three (3) stories
	Accessory	In no case higher than the principal building
Zoning Districts	Permitted: LR, MR, NR-1	

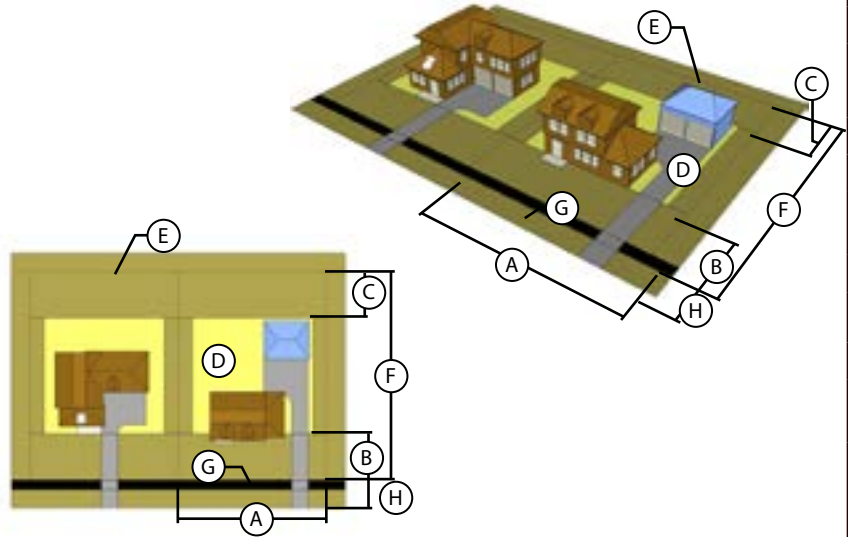

TYPE DD6: DETACHED DWELLING / STANDARD LOT

Lot Frontage (min.)		55'
Setbacks: Principal Building (min.)	Front	25'
	Side	5'
	Rear	20'
Setbacks: Accessory Building (min.)	Front	10' behind front building line
	Side	5'
	Rear	5'
Total Lot Coverage (max.)		60%
Building Height (max.)	Principal	Up to three (3) stories
	Accessory	In no case higher than the principal building
Zoning Districts	Permitted: MR, HR, NR-1, NR-2, NR-3	

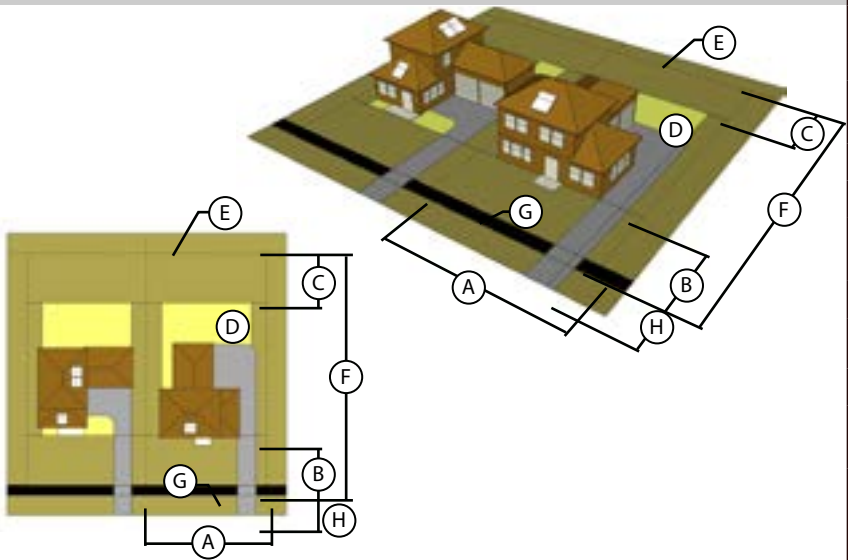

- | | |
|------------------------|-------------------------|
| (A) Frontage | (E) Property Boundary |
| (B) Front Setback | (F) Depth |
| (C) Rear Setback | (G) Public Sidewalk |
| (D) Buildable Lot Area | (H) Public Right-of-way |

ARTICLE 5 ZONING REGULATIONS

5.1 GENERAL PROVISIONS

TYPE DD7: DETACHED DWELLING / SMALL LOT

Lot Frontage (min.)		40' 45' on corner lots
Setbacks: Principal Building (min.)	Front	25'
	Side	5' 10' on street side corner lots
	Rear	20'
Setbacks: Accessory Building (min.)	Front	10' behind front building line
	Side	2', 0' if party wall [a] 15' on street side corner lots
	Rear	2' 5' if alley loaded
Total Lot Coverage (max.)		60%
Building Height (max.)	Principal	Up to three (3) stories
	Accessory	In no case higher than the principal building
Zoning Districts		Permitted: MR, HR, NR-1, NR-2, NR-3

[a] 0' setbacks on attached buildings require a party wall meeting all building code standards and proper designation on a recorded plat.

TYPE DD8: DETACHED DWELLING / URBAN LOT

Lot Frontage (min.)		30' 42' on corner lots
Setbacks: Principal Building (min.)	Front	15'
	Side	3', but at least 10' both sides combined [a] 10' on street side corner lots
	Rear	20'
Setbacks: Accessory Building (min.)	Front	10' behind front building line
	Side	2', 0' if party wall [a] 15' on street side corner lots
	Rear	2' 5' if alley loaded
Total Lot Coverage (max.)		70%
Building Height (max.)	Principal	Up to three (3) stories
	Accessory	In no case higher than the principal building
Zoning Districts		Permitted: NR-2, NR-3

[a] Setbacks of 0' are allowed for zero lot line development provided a minimum 10' separation is maintained between all principal buildings and appropriate maintenance easements and covenants are recorded with the plat.

(A) Frontage	(D) Buildable Lot Area	(G) Public Sidewalk	(J) Alley
(B) Front Setback	(E) Property Boundary	(H) Public Right-of-way	
(C) Rear Setback	(F) Depth	(I) Shared Driveway	

ARTICLE 5 ZONING REGULATIONS

5.1 GENERAL PROVISIONS

b. Semi-Attached Dwelling (“Duplex”) Lot Type and Building Standards.

TYPE SD1: SEMI-ATTACHED DWELLING / LARGE LOT		
Lot Frontage (min.)		40' 45' on corner lots
Setbacks: Principal Building (min.)	Front	Context of other adjacent detached dwellings or 25', whichever is less.
	Side	0' attached side [a] 5' detached side 10' on street side corner lots
	Rear	20'
Setbacks: Accessory Building (min.)	Front	10' behind front building line
	Side	2', 0' if party wall [a] 15' on street side corner lots
	Rear	2' 5' if alley loaded
Total Lot Coverage (max.)		60%
Building Height (max.)	Principal	Up to three (3) stories
	Accessory	In no case higher than the principal building
Zoning Districts	Permitted: LR, NR-1, MR	

[a] 0' setbacks on attached dwellings require a party wall meeting all building code standards and proper designation on a recorded plat.

(A) Frontage	(D) Accessory Building	(G) Public Sidewalk
(B) Side Setback	(E) Property Boundary	(H) Public Right-of-way
(C) Rear Setback	(F) Depth	(I) Shared Driveway

ARTICLE 5

ZONING REGULATIONS

5.1 GENERAL PROVISIONS

TYPE SD2: SEMI-ATTACHED DWELLING / STANDARD LOT

Lot Frontage (min.)		35' 40' on corner lots
Setbacks: Principal Building (min.)	Front	Context of other adjacent detached dwellings or 25', whichever is less.
	Side	0' attached side [a] 5' detached side 10' on street side corner lots
	Rear	20'
Setbacks: Accessory Building (min.)	Front	10' behind front building line
	Side	2', 0' if party wall [a] 15' on street side corner lots
	Rear	2' 5' if alley loaded
Total Lot Coverage (max.)		60%
Building Height (max.)	Principal	Up to three (3) stories
	Accessory	In no case higher than the principal building
Zoning Districts	Permitted: MR, HR, NR-1, NR-2, NR-3	

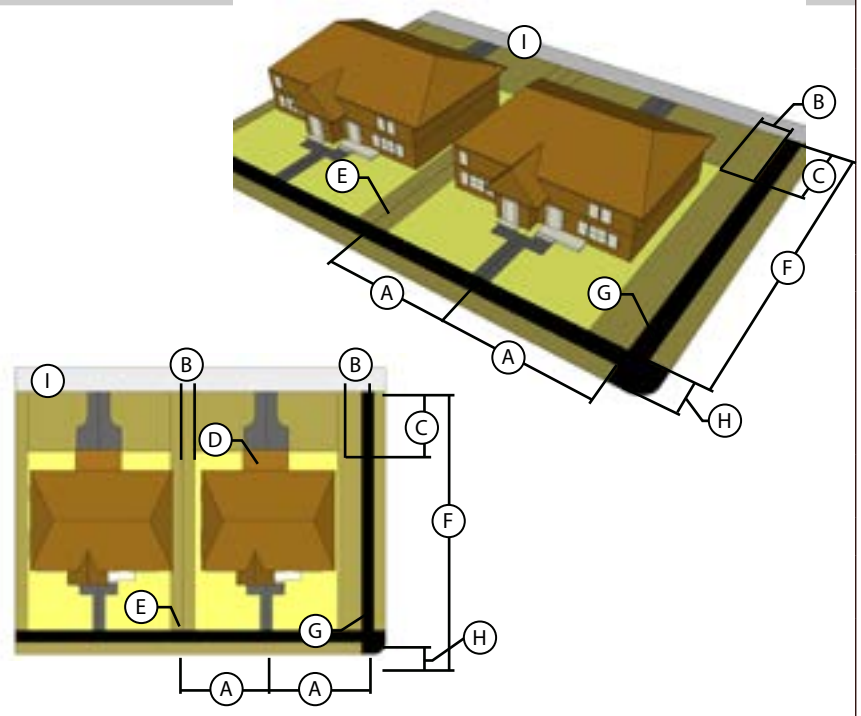

[a] 0' setbacks on attached dwellings require a party wall meeting all building code standards and proper designation on a recorded plat.

(A) Frontage	(D) Accessory Building	(G) Public Sidewalk
(B) Side Setback	(E) Property Boundary	(H) Public Right-of-way
(C) Rear Setback	(F) Depth	(I) Alley

ARTICLE 5 ZONING REGULATIONS

5.1 GENERAL PROVISIONS

TYPE SD3: SEMI-ATTACHED DWELLING / SMALL LOT

Lot Frontage (min.)		30' 35' on corner lots
Setbacks: Principal Building (min.)	Front	Context of other adjacent detached dwellings or 25', whichever is less.
	Side	0' attached side [a] 5' detached side 10' on street side corner lots
	Rear	20'
Setbacks: Accessory Building (min.)	Front	10' behind front building line
	Side	2', 0' if party wall [a] 15' on street side corner lots
	Rear	2' 5' if alley loaded
Total Lot Coverage (max.)		60%
Building Height (max.)	Principal	Up to three (3) stories
	Accessory	In no case higher than the principal building
Zoning Districts		Permitted: MR, HR, NR-2, NR-3

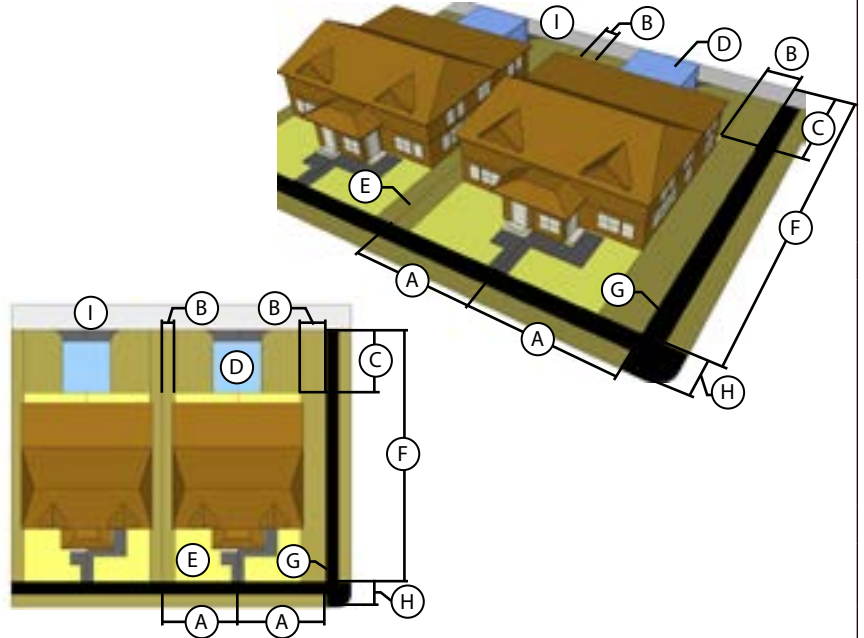

[a] 0' setbacks on attached dwellings require a party wall meeting all building code standards and proper designation on a recorded plat.

(A) Frontage	(D) Accessory Building	(G) Public Sidewalk
(B) Side Setback	(E) Buildable Lot Area	(H) Public Right-of-way
(C) Rear Setback	(F) Depth	(I) Alley

ARTICLE 5

ZONING REGULATIONS

5.1 GENERAL PROVISIONS

c. Attached Dwellings (“Townhouse”) Lot Type and Building Standards.

TYPE AD1: ATTACHED DWELLING / LARGE LOT		
Lot Frontage (min.)		25' 30' on corner lots
Setbacks: Principal Building (min.)	Front	15' – 25' [b]
	Side	0' attached side [a] 5' detached side 10' on street side corner lots
	Rear	20'
Setbacks: Accessory Building (min.)	Front	10' behind front building line
	Side	2', 0' if party wall [a] 15' on street side corner lots
	Rear	2' 5' if alley loaded
Total Lot Coverage (max.)		70%
Building Height (max.)	Principal	Up to three (3) stories
	Accessory	In no case higher than the principal building
Zoning Districts	Permitted: MR, HR, NR-2, NR-3	

[a] 0' setbacks on attached dwellings require a party wall meeting all building code standards and proper designation on a recorded plat.

[b] The front building line shall be located based on the context of any other adjacent detached dwellings, and located within 5' of the setbacks for these buildings, but no greater than 30'.

(A) Frontage	(D) Property Boundary	(G) Buildable Lot Area
(B) Front Setback	(E) Depth	(H) Alley
(C) Accessory Building	(F) Public Sidewalk	

ARTICLE 5

ZONING REGULATIONS

5.1 GENERAL PROVISIONS

TYPE AD2: ATTACHED DWELLING / STANDARD LOT		
Lot Frontage (min.)		20' 25' on corner lots
Setbacks: Principal Building (min.)	Front	10' – 20' [b]
	Side	0' attached side [a] 5' detached side 10' on street side corner lots
	Rear	20' 5' if alley loaded
Setbacks: Accessory Building (min.)	Front	10' behind front building line
	Side	2' 0' if party wall [a] 10' on street side corner lots
	Rear	2' 5' if alley loaded
Total Lot Coverage (max.)		70%
Building Height (max.)	Principal	Up to three (3) stories
	Accessory	In no case higher than the principal building
Zoning Districts		Permitted: HR, NR-2, NR-3

- [a] 0' setbacks on attached dwellings require a party wall meeting all building code standards and proper designation on a recorded plat.
 [b] The front building line shall be located based on the context of any other adjacent detached dwellings, and located within 5' of the setbacks for these buildings, but no greater than 25'.

(A) Frontage	(D) Property Boundary	(G) Buildable Lot Area
(B) Front Setback	(E) Depth	(H) Alley
(C) Accessory Building	(F) Public Sidewalk	

ARTICLE 5

ZONING REGULATIONS

5.1 GENERAL PROVISIONS

TYPE AD3: ATTACHED DWELLING / SMALL LOT		
Lot Frontage (min.)		16' 24' on end units or corner lots
Setbacks: Principal Building (min.)	Front	10' – 20' [b]
	Side	0' attached side [a] 5' detached side 10' on street side corner lots
	Rear	20' 5' if alley loaded
Setbacks: Accessory Building (min.)	Front	10' behind front building line
	Side	2' 0' if party wall [a] 10' on street side corner lots
	Rear	2' 5' if alley loaded
Total Lot Coverage (max.)		85%
Building Height (max.)	Principal	Up to three (3) stories
	Accessory	In no case higher than the principal building
Zoning Districts		Permitted: NR-3 Conditional: NR-2

- [a] 0' setbacks on attached dwellings require a party wall meeting all building code standards and proper designation on a recorded plat.
- [b] The front building line shall be located based on the context of any other adjacent detached dwellings, and located within 5' of the setbacks for these buildings, but no greater than 25'.

Ⓐ Frontage	Ⓓ Property Boundary	Ⓔ Buildable Lot Area
Ⓑ Front Setback	Ⓔ Depth	Ⓕ Alley
Ⓒ Accessory Building	Ⓕ Public Sidewalk	

ARTICLE 5

ZONING REGULATIONS

5.1 GENERAL PROVISIONS

d. **Multi-dwelling Buildings (“Apartment”) Lot Type and Building Standards.**

TYPE MD1: MULTI-DWELLING BUILDING / LARGE LOT		
Lot Area (min.)	20,000 square feet	
Lot Frontage (min.)	150'	
Setbacks: Principal Building (min.)	Front	30'
	Side	15' 30' on street side corner lots
	Rear	30'
Setbacks: Accessory Building (min.)	Front	10' behind front building line
	Side	15' 30' on street side corner lots
	Rear	10'
Total Lot Coverage (max.)	80%	
Building Height	Principal	2 to 3 stories Up to 5 stories with conditional review
	Accessory	Up to 2 stories
Zoning Districts	Permitted: NR-3 Conditional: MR, HR, NR-2	

- | | | |
|-------------------|------------------------|------------------------|
| (A) Frontage | (D) Accessory Building | (G) Public Sidewalk |
| (B) Front Setback | (E) Property Boundary | (H) Buildable Lot Area |
| (C) Rear Setback | (F) Depth | |

ARTICLE 5

ZONING REGULATIONS

5.1 GENERAL PROVISIONS

TYPE MD2: MULTI-DWELLING BUILDING / STANDARD LOT		
<i>Lot Area</i>		9,000 – 19,999 square feet
<i>Lot Frontage</i>		80' – 150'
<i>Setbacks: Principal Building (min.)</i>	<i>Front</i>	10' – 20'
	<i>Side</i>	5' 15' on street side corner lots
	<i>Rear</i>	15' 5' if alley loaded
<i>Setbacks: Accessory Building (min.)</i>	<i>Front</i>	10' behind front building line
	<i>Side</i>	5' 15' on street side corner lots
	<i>Rear</i>	2' 5' if alley loaded
<i>Total Lot Coverage (max.)</i>		80%
<i>Building Height</i>	<i>Principal</i>	2 to 3 stories Up to 5 stories with conditional review
	<i>Accessory</i>	Up to 2 stories
<i>Zoning Districts</i>	Permitted: HR, NR-3, NR-2 Conditional: MR	

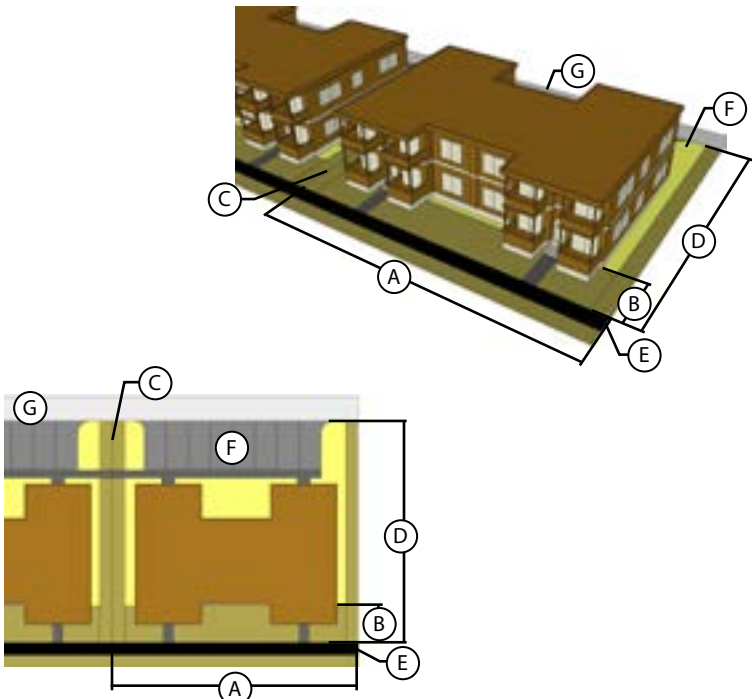

- | | | |
|-----------------------|------------------------|-----------|
| (A) Frontage | (D) Depth | (G) Alley |
| (B) Front Setback | (E) Public Sidewalk | |
| (C) Property Boundary | (F) Buildable Lot Area | |

ARTICLE 5

ZONING REGULATIONS

5.1 GENERAL PROVISIONS

TYPE MD3: MULTI-DWELLING BUILDING / SMALL LOT		
Lot Area	≤ 8,999 square feet	
Lot Frontage	50' – 80'	
Setbacks: Principal Building (min.)	Front	10' – 20'
	Side	5' 15' on street side corner lots
	Rear	15' 5' if alley loaded
Setbacks: Accessory Building (min.)	Front	10' behind front building line
	Side	5' 15' on street side corner lots
	Rear	2' 5' if alley loaded
Total Lot Coverage (max.)	80%	
Building Height	Principal	2 to 3 stories Up to 5 stories with conditional review
	Accessory	Up to 2 stories
Zoning Districts	Permitted: HR, NR-2, NR-3 Conditional: MR	

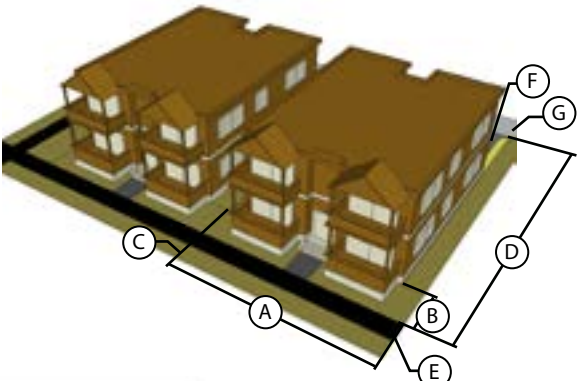
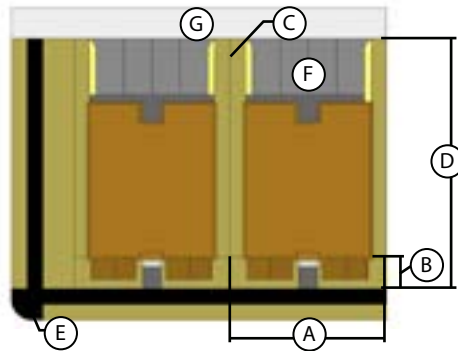
- | | | |
|-----------------------|------------------------|-----------|
| (A) Frontage | (D) Depth | (G) Alley |
| (B) Front Setback | (E) Public Sidewalk | |
| (C) Property Boundary | (F) Buildable Lot Area | |

- e. **Residential Zoning Districts and Lot and Building Types.** Table 5-2 establishes the lot and building types allowed for each residential zoning district.

TABLE 5-2: SUMMARY OF RESIDENTIAL ZONING DISTRICTS AND LOT AND BUILDING TYPES

Lot Type Zoning District	Detached Dwelling Lots								Semi-Attached Dwelling Lots ("Duplex")			Attached Dwelling Lots ("Townhouse")			Multi-dwelling Lots ("Apartments")		
	Ag. DD1	Rural DD2	Large DD3	Low-den DD4	Suburban DD5	Standard DD6	Small DD7	Urban DD8	Large SD1	Standard SD2	Small SD3	Large AD1	Standard AD2	Small AD3	Large MD1	Standard MD2	Small MD3
AG	P																
AR	P	P	P														
RR		P	P														
LR			P	P	P			P									
MR					P	P		P	P	P	P	P		C	C	C	C
HR						P				P	P	P	P				
NR-1				P	P	P			P								
NR-2						P	P	P		P	P	P	P	C	C	C	P
NR-3						P	P	P		P	P	P	P	P	P	P	P

Key: P = Permitted by right subject to general district standards
 C = Permitted subject to discretionary conditional review process

5.2 RURAL AND AGRICULTURE DISTRICTS STANDARDS

- 5.2.1 AG – Agriculture District
- 5.2.2 AR – Agriculture Residential District
- 5.2.3 RR – Rural Residential District

5.2.1 AG – Agriculture District

- a. **Intent.** The AG District is intended for agriculture uses or other use of lands in a natural state. Agriculture-related residential uses and agriculture-related businesses are included provided they support the primary use of the land for farming, ranching, or agriculture uses. All uses require little or no public infrastructure in the short term, or rural level standards in the interim or long term. The regulations are designed to protect agriculture uses in the City and the open rural character of the districts by prohibiting the establishment of scattered business, industrial, and other uses that are unrelated to the predominantly agricultural character or any general plan of development and that might inhibit the best future urban utilization of the land.
- b. **Applicability.** The AG District is applicable to any areas where significant natural lands or open spaces are to be protected, and specifically the Agriculture/Rural or Rural Residential Category in the Cheyenne Comprehensive Plan.
- c. **Context.** The Agriculture District is also applicable as an interim or holding zone for areas that may be further developed, re-subdivided and reclassified in the long term, but where minimal development activity in the interim is acceptable and will not prematurely establish a development pattern through infrastructure investments, street networks, or smaller lot patterns. Less connected street networks and rural street cross sections are appropriate to support lots in this district.
- d. **Eligible Lot and Building Types.** The following lot types, building types and dimensions specified in Table 5-2 are permitted in the AG district:
 - 1. Agriculture Lot / Detached Dwelling (Type DD1), with well and septic subject to State Department of Environmental Quality Standards and the City/County Health Department Standards.
- e. **Permitted Uses.** The uses permitted in the AG district are specified in Table 5-1 as either “permitted” or “administrative” or “conditional.”

5.2.2 AR – Agricultural Residential District

- a. **Intent.** The AR District is intended for agriculture and residential uses on large lots that typify a rural lifestyle. All uses require little or no public infrastructure in the short term, or rural level standards in the interim or long term. The regulations are designed to protect the essentially open rural character of the districts and enable a range of accessory agriculture uses in association with rural living.
- b. **Applicability.** The AR District is applicable to any areas where very low-density residential and limited agriculture uses are acceptable as the long-range development pattern, and specifically the Rural Residential Category in the Cheyenne Comprehensive Plan. It is also acceptable in limited application in the Urban Transition Category.
- c. **Context.** This district is also appropriate as a base zoning in conjunction with Rural Cluster development patterns that can better and permanently preserve greater amounts of contiguous open space in conjunction with low-density residential development. Less connected street networks and rural street cross sections are appropriate to support lots in this district.
- d. **Eligible Lot and Building Types.** The following lot types, building types and dimensions specified in Table 5-2 are permitted in the AR district:
 - 1. Agriculture Lot / Detached Dwelling (Type DD1), with well and septic subject to State Department of Environmental Quality Standards.
 - 2. Rural Lot / Detached Dwelling (Type DD2), with well and septic subject to State Department of Environmental Quality Standards.
 - 3. Large Lot / Detached Dwelling (Type DD3), only if property is served by an approved central water distribution system or sewer collection treatment system, subject to a recommendation for approval from the State Department of Environmental Quality.
 - 4. Low-density Lot / Detached Dwelling (Type DD4), if property is served by an approved central water distribution system and sewer collection treatment system, subject to a recommendation for approval from the State Department of Environmental Quality.
- e. **Permitted Uses.** The uses permitted in the AR district are specified in Table 5-1 as either “permitted” or “administrative” or “conditional.”

5.2.3 RR Rural Residential District

- a. **Intent.** The RR District is intended for residential uses on large lots that typify a semi-rural lifestyle. All uses require little or no public infrastructure in the short term, or rural level standards in the interim or long term. The regulations are designed to protect the essentially open rural character of the districts and protect the primarily residential use of land.
- b. **Applicability.** The RR District is applicable to any areas where very low-density residential and are acceptable as the long-range development pattern, and specifically the Rural Residential Category in the Cheyenne Comprehensive Plan. It is also acceptable in limited application in the Urban Transition Category.
- c. **Context.** Large uninterrupted applications of this district without transitions to either higher densities or more rural open spaces should be avoided so that significant populated areas that must rely solely on automobile travel and which are remote from necessary municipal services are not created. This district is also appropriate as a base zoning in conjunction with the Open Space Design Option that can better and permanently preserve greater amounts of contiguous open space in conjunction with low-density residential development. Less connected street networks and rural street cross sections are appropriate to support lots in this district.
- d. **Eligible Lot and Building Types.** The following lot types, building types and dimensions specified in Table 5-2 are permitted in the RR district:
 - 1. Rural Lot / Detached Dwelling (Type DD2)
 - 2. Large Lot / Detached Dwelling (Type DD3)
- e. **Permitted Uses.** The uses permitted in the RR district are specified in Table 5-1 as either "permitted" or "administrative" or "conditional."

5.3 RESIDENTIAL NEIGHBORHOOD DISTRICTS STANDARDS

- 5.3.1 LR – Low-density Residential District
- 5.3.2 Reserved
- 5.3.3 MR – Medium-density Residential District
- 5.3.4 Reserved
- 5.3.5 HR – High-density Residential District
- 5.3.6 Reserved
- 5.3.7 NR-1 – Neighborhood Residential – Moderate Density
- 5.3.8 NR-2 – Neighborhood Residential – Medium Density
- 5.3.9 NR-3 – Neighborhood Residential – High Density

5.3.1 LR Low-density Residential District

- a. **Intent.** The LR District is intended for a mix of lower density dwellings. All uses require full access to public infrastructure and city services. The regulations are designed to protect the neighborhood character of the district and protect the primarily residential use of land.
- b. **Applicability.** The LR District is applicable to areas where suburban development patterns are desired, and specifically the Urban Transition Residential Category in the Cheyenne Comprehensive Plan.
- c. **Context.** Typically this district should be used only in areas that are no more than 1 mile from any existing or planned Activity Center. Large uninterrupted applications of this district without transitions to either higher densities and activity centers or to more rural open spaces should be avoided so that significant populated areas that must rely solely on automobile travel and which are remote from necessary municipal services are not created.
- d. **Eligible Lot and Building Types.** The following lot types, building types and dimensions specified in Table 5-2 are permitted in the LR District:
 - 1. Large Lot / Detached Dwelling (Type DD3)
 - 2. Low-density Lot / Detached Dwelling (Type DD4)
 - 3. Suburban Lot / Detached Dwelling (Type DD5)
 - 4. Large Lot / Semi-attached Dwelling (Type SD1)

- e. **Permitted Uses.** The uses permitted in the LR District are specified in Table 5-1 as either “permitted” or “administrative” or “conditional.”
- f. **Site and Building Design Standards.** To create neighborhood character and visual diversity for housing options, the General Residential Design Standards in Section 6.6 and access standards in Section 4.3 shall apply in the LR Zoning District.

5.3.2 [RESERVED]

Previously, this section contained LR-2 District regulations, which were discontinued. Please use LR District regulations.

5.3.3 MR Medium-density Residential District

- a. **Intent.** The MR District is intended for a mix of density and dwelling types within a neighborhood. All uses require full access to public infrastructure and city services. The regulations are designed to protect the neighborhood character of the district and protect the primarily residential use of land.
- b. **Applicability.** The MR District is applicable to areas where more compact neighborhood development patterns are desired, and specifically the Urban Residential Category in the Cheyenne Comprehensive Plan.
- c. **Context.** Typically this district should be used only in areas that are no more than ½ mile from any existing or planned Activity Center. Large uninterrupted applications of this district without transitions to activity centers should be avoided so that significant populated areas that must rely solely on automobile travel and which are remote from necessary municipal services are not created. This district should be supported by a highly connected street network with street design types that have low design speeds and residential character streetscapes.
- d. **Eligible Lot and Building Types.** The following lot types, building types and dimensions specified in Table 5-2 are permitted in the MR District:

1. Suburban Lot / Detached Dwelling (Type DD5)
2. Standard Lot / Detached Dwelling (Type DD6)
3. Small Lot / Detached Dwelling (Type DD7)
4. Standard Lot / Semi-attached Dwelling (Type SD2)

5. Small Lot / Semi-attached Dwelling (Type SD3)
6. Large Lot / Attached Dwelling (Type AD1)
7. Small Lot / Multi-dwelling Building (Type MD3) – as conditional approval
8. Standard Lot / Multi-dwelling Building (Type MD2) – as conditional approval
9. Large Lot / Multi-dwelling Building (Type MD1) – as conditional approval

- e. **Permitted Uses.** The uses permitted in the MR District are specified in Table 5-1 as either “permitted” or “administrative” or “conditional.”

- f. **Site and Building Design Standards.** To create neighborhood character and visual diversity for housing options, the General Residential Design Standards in Section 6.6 and access standards in Section 4.3 shall apply in the MR Zoning District.

5.3.4 [RESERVED]

Previously, this section contained MR-2 District regulations, which were discontinued. Please use MR District regulations.

5.3.5 HR High-density Residential District

- a. **Intent.** The HR District is intended for a range of higher density, urban residential lots and building types within a neighborhood. All uses require full access to public infrastructure and city services. The regulations are designed to protect the urban character of the district and protect the primarily residential use of land.
- b. **Applicability.** The HR District is applicable to areas where more compact neighborhood development patterns are desired, and specifically the Urban Residential Category in the Cheyenne Comprehensive Plan.
- c. **Context.** Typically this district should be used only in areas that are no more than ¼ mile or up to 4 blocks from any existing or planned Activity Center. Isolated applications of this district without adjacency to activity centers should be avoided so that significant concentrations of density do not exist without convenient access to supporting and compatible non-residential uses and quality urban amenities. This district should be supported by a highly connected street network with street design types that have a high degree of pedestrian amenities.

- d. **Eligible Lot and Building Types.** The following lot types, building types and dimensions specified in Table 5-2 are permitted in the HR District:
 - 1. Standard Lot / Detached Dwelling (Type DD6)
 - 2. Small Lot / Detached Dwelling (Type DD7)
 - 3. Standard Lot / Semi-attached Dwelling (Type SD2)
 - 4. Small Lot / Semi-attached Dwelling (Type SD3)
 - 5. Large Lot / Attached Dwelling (Type AD1)
 - 6. Standard Lot / Attached Dwelling (Type AD2)
 - 7. Small Lot / Multi-dwelling Building (Type MD3)
 - 8. Standard Lot / Multi-dwelling Building (Type MD2)
 - 9. Large Lot / Multi-dwelling Building (Type MD1)
 - 10. Live / Work Building (Type NB1) – as administrative approval, subject to NB district standards for this building and lot type and Section 5.7.7
- e. **Permitted Uses.** The uses permitted in the HR District are specified in Table 5-1 as either “permitted” or “administrative” or “conditional.”
- f. **Site and Building Design Standards.** Due to the more compact development pattern, range of smaller lot types, and the close relationship of the smaller lots to the public streetscape, the Residential Design Standards in Section 6.6 and access standards in Section 4.3 shall apply in the HR Zoning District.

5.3.6 [RESERVED]

Previously, this section contained HR-2 District regulations, which were discontinued. Please use HR District regulations.

5.3.7 NR-1 Neighborhood Residential – Moderate Density District

- a. **Intent.** The NR-1 District is intended for a mix of moderate-density, detached and semi-attached dwellings on a variety of lot types that promote a consistent neighborhood character. All uses require full access to public infrastructure and city services. The regulations are designed to protect the neighborhood character of the district and protect the primarily residential use of land. The overall density of this district should be between 5 and 12 dwelling units per acre.
- b. **Applicability.** The NR-1 District is applicable to areas where more compact neighborhood development patterns are desired, and specifically the Urban Residential Category in

the Cheyenne Comprehensive Plan.

- c. **Context.** Typically this district should be used only in areas that are no more than ½ mile from any existing or planned Activity Center. Large uninterrupted applications of this district without transitions to activity centers should be avoided so that significant populated areas that must rely solely on automobile travel and which are remote from necessary municipal services are not created. This district should be supported by a highly connected street network with street design types that have low design speeds and residential character streetscapes.
- d. **Eligible Lot and Building Types.** The following lot types, building types and dimensions specified in Table 5-2 are permitted in the NR-1 District:
 - 1. Low-density Lot / Detached Dwelling (Type DD4)
 - 2. Suburban Lot / Detached Dwelling (Type DD5)
 - 3. Standard Lot / Detached Dwelling (Type DD6)
 - 4. Small Lot / Detached Dwelling (Type DD7)
 - 5. Large Lot / Semi-attached Dwelling (Type SD1)
 - 6. Standard Lot / Semi-attached Dwelling (Type SD2)
- e. **Permitted Uses.** The uses permitted in the NR-1 District are specified in Table 5-1 as either “permitted” or “administrative” or “conditional.”
- f. **Site and Building Design Standards.** Due to the more compact development pattern, range of smaller lot types, and the close relationship of the smaller lots to the public streetscape, the Residential Design Standards in Section 6.6 and access standards in Section 4.3 shall apply in the NR-1 Zoning District.

5.3.8 NR-2 Neighborhood Residential – Medium Density District

- a. **Intent.** The NR-2 District is intended for a medium density and mix of dwelling types that promote a consistent neighborhood character. All uses require full access to public infrastructure and city services. The regulations are designed to protect the neighborhood character of the district and protect the primarily residential use of land. The overall density of this district should be between 10 and 18 dwelling units per acre.
- b. **Applicability.** The NR-2 District is applicable to areas where more compact neighborhood development patterns are

desired, and specifically the Urban Residential Category in the Cheyenne Comprehensive Plan.

- c. **Context.** Typically this district should be used only in areas that are no more than ½ mile from any existing or planned Activity Center. Large uninterrupted applications of this district without transitions to activity centers should be avoided so that significant populated areas that must rely solely on automobile travel and which are remote from necessary municipal services are not created. This district should be supported by a highly connected street network with street design types that have low design speeds and residential character streetscapes.
- d. **Eligible Lot and Building Types.** The following lot types, building types and dimensions specified in Table 5-2 are permitted in the NR-2 District:
1. Standard Lot / Detached Dwelling (Type DD6)
 2. Small Lot / Detached Dwelling (Type DD7)
 3. Urban Lot / Detached Dwelling (Type DD8)
 4. Standard Lot / Semi-attached Dwelling (Type SD2)
 5. Small Lot / Detached Dwelling (Type SD3)
 6. Large Lot / Attached Dwelling (Type AD1)
 7. Standard Lot / Attached Dwelling (Type AD2)
 8. Small Lot / Attached Dwelling (Type AD3) – as conditional approval.
 9. Small Lot / Multi-dwelling Building (Type MD3)
 10. Standard Lot / Multi-dwelling Building (Type MD2)
 11. Large Lot / Multi-dwelling Building (Type MD1) – as conditional approval,
 12. Live / Work Building (Type NB1) – as conditional approval, subject to NB district standards for this building and lot type and Section 5.7.7.
- e. **Permitted Uses.** The uses permitted in the NR-2 District are specified in Table 5-1 as either “permitted” or “administrative” or “conditional.”
- f. **Site and Building Design Standards.** Due to the more compact development pattern, range of smaller lot types, and the close relationship of the smaller lots to the public streetscape, the Residential Design Standards in Section 6.6 and access standards in Section 4.3 shall apply in the NR-2 Zoning District.

5.3.9 NR-3 Neighborhood Residential – High Density District

- a. **Intent.** The NR-3 District is intended primarily for high-density, urban residential uses with consistent neighborhood character. All uses require full access to public infrastructure and city services. The regulations are designed to protect the neighborhood character of the district and protect the primarily residential use of land. The overall density of this district should be more than 15 dwelling units per acre.
- b. **Applicability.** The NR-3 District is applicable to areas where more compact neighborhood development patterns are desired, and specifically the Urban Residential Category in the Cheyenne Comprehensive Plan.
- c. **Context.** Typically this district should be used only in areas that are no more than ¼ mile or up to 4 blocks from any existing or planned Activity Center. Isolated applications of this district without adjacency to activity centers should be avoided so that significant concentrations of density do not exist without walking access to non-residential uses and quality urban amenities. This district should be supported by a highly connected street network with street design types that have a high degree of pedestrian amenities.
- d. **Eligible Lot and Building Types.** The following lot types, building types and dimensions specified in Table 5-2 are permitted in the NR-3 District:
1. Standard Lot / Detached Dwelling (Type DD6)
 2. Small Lot / Detached Dwelling (Type DD7)
 3. Urban Lot / Detached Dwelling (Type DD8)
 4. Standard Lot / Semi-attached Dwelling (Type SD2)
 5. Small Lot / Detached Dwelling (Type SD3)
 6. Large Lot / Attached Dwelling (Type AD1)
 7. Standard Lot / Attached Dwelling (Type AD2)
 8. Small Lot / Attached Dwelling (Type AD3)
 9. Small Lot / Multi-dwelling Building (Type MD3)
 10. Standard Lot / Multi-dwelling Building (Type MD2)
 11. Large Lot / Multi-dwelling Building (Type MD1)
 12. Live / Work (Type NB1) – as administrative approval subject to the NB district standards for this building and lot type and Section 5.7.7.
 13. Urban Loft (Type NB3) – as conditional approval

- e. **Permitted Uses.** The uses permitted in the NR-3 District are specified in Table 5-1 as either “permitted” or “administrative” or “conditional.”
- f. **Site and Building Design Standards.** Due to the more compact development pattern, range of smaller lot types, and the close relationship of the smaller lots to the public streetscape, the Residential Design Standards in Section 6.6 and access standards in Section 4.3 shall apply in the NR-3 Zoning District. Due to the nature of the urban loft lot type, the mixed use and small scale commercial design standards in Section 6.7 shall apply for this lot type in the NR-3 District.

5.4 Commercial and Mixed-use Districts Standards

- 5.4.1 NB – Neighborhood Business District
- 5.4.2 CB – Community Business District
- 5.4.3 CBD – Central Business District
- 5.4.4 MUR – Mixed-Use Residential District
- 5.4.5 MUB – Mixed-Use Business District
- 5.4.6 MUE – Mixed-Use Employment District
- 5.4.7 BP – Business Park

5.4.1 NB – Neighborhood Business District

- a. **Intent.** The NB District is intended for Retail, Employment, Service and Civic uses to support adjacent residential neighborhoods in meeting most of the daily needs of residents within close proximity to dwellings. The district should feature businesses that typically serve a target market area of ½ to 1 mile for the majority of its on-site business. Small-scale uses developed in a more compact and pedestrian oriented format allow these uses to exist compatibly and well-connected to neighborhoods, with suitable and well designed transitions. The district regulations are designed to promote small-scale business uses tightly integrated with surrounding residential uses.
- b. **Applicability.** The NB District is applicable to any area where small-scale retail and services are desired to support adjacent residential uses, specifically the Neighborhood Business Centers and smaller Mixed-use Commercial Activity Centers in the Comprehensive Plan.
- c. **Context.** The total area of the district typically entails no more than 5 to 20 acres (2 to 8 blocks) in its entirety, without transitioning to the adjacent and supportive uses and zoning districts (individual applications may be smaller). The district should include between 10,000 to 125,000 total square feet of Retail uses for the entirety of the district, with the larger end of this range justified where planned or existing residential densities are higher. The district should be located at least ½ mile from other similar districts or activity centers, unless high residential densities support more frequent location of neighborhood activity centers. The NB district requires a highly connected transportation network within the district and surrounding areas, with smaller blocks and pedestrian-oriented streetscapes on the primary streets.

ARTICLE 5 ZONING REGULATIONS

5.4 COMMERCIAL AND MIXED-USE DISTRICTS STANDARDS

d. **Lot and Building Standards.** The following lot types, building types and dimensions specified in the tables are permitted in the NB district:

TYPE NB1: LIVE / WORK		
Lot Area	1,200 – 5,000 square feet	
Lot Frontage	16' – 40' 24' – 50' on end units or corner lots	
Setbacks:	Front	0' to 20'
	Side	0' if party wall[a] or corner lots 5' in all other cases
	Rear	15' 5' if alley loaded
Building Height	2 to 3 stories Up to 3.5 stories as conditional review	
Total Lot Coverage (max.)	80%	

[a] 0' setbacks on attached buildings require a party wall meeting all building code standards and proper designation on a recorded plat.

TYPE NB2: MIXED-USE BUILDING		
Lot Area	2,000 – 20,000 square feet, or up to ¼ of a block, whichever is greater	
Lot Frontage	25' – 150'	
Setbacks:	Front	0' to 20'
	Side	0' if party wall[a] or corner lots 5' in all other cases
	Rear	15' 5' if alley loaded
Building Height	2 to 3 stories Up to 3.5 stories as conditional review	
Total Lot Coverage (max.)	90%	

[a] 0' setbacks on attached buildings require a party wall meeting all building code standards and proper designation on a recorded plat.

(A) Frontage	(D) Depth	(G) Alley
(B) Side Setback	(E) Buildable Lot Area	
(C) Rear Setback	(F) Public Sidewalk	

ARTICLE 5 ZONING REGULATIONS

5.4 COMMERCIAL AND MIXED-USE DISTRICTS STANDARDS

TYPE NB3: URBAN LOFT BUILDING		
Lot Area	2,000 square feet or up to ½ of a block, whichever is greater	
Lot Frontage	25' – 200'	
Setbacks:	Front	0' to 20'
	Side	0' if party wall[a] or corner lots, 5' in all other cases
	Rear	15', 5' if alley loaded
Building Height	2 to 6 stories	
Total Lot Coverage (max.)	90%	

[a] 0' setbacks on attached buildings require a party wall meeting all building code standards and proper designation on a recorded plat.

TYPE NB4: COMMERCIAL BUILDING / SMALL LOT		
Lot Area	2,000 – 7,999 square feet	
Lot Frontage	25' – 80'	
Setbacks:	Front	0' to 10'
	Side	0' if party wall[a] or corner lots 5' in all other cases
	Rear	15', 5' if alley loaded
Building Height	1 to 2 stories Up to 3 stories as conditional review	
Total Lot Coverage (max.)	90%	

[a] 0' setbacks on attached buildings require a party wall meeting all building code standards and proper designation on a recorded plat.

(A) Frontage	(D) Depth	(G) Alley
(B) Side Setback	(E) Buildable Lot Area	
(C) Rear Setback	(F) Public Sidewalk	

ARTICLE 5 ZONING REGULATIONS

5.4 COMMERCIAL AND MIXED-USE DISTRICTS STANDARDS

TYPE NB5: COMMERCIAL BUILDING / LARGE LOT

Lot Area	8,000 - 60,000 square feet, or up to ¼ of a block, whichever is greater	
Lot Frontage	80' - 400'	
Setbacks:	Front	0' to 10' Greater than 10' by conditional review
	Side	0' if party wall [a]; 10' in all other cases
	Rear	15' 5' if alley loaded
Building Height	1 to 2 stories Up to 3 stories as conditional review	
Total Lot Coverage (max.)	70%	

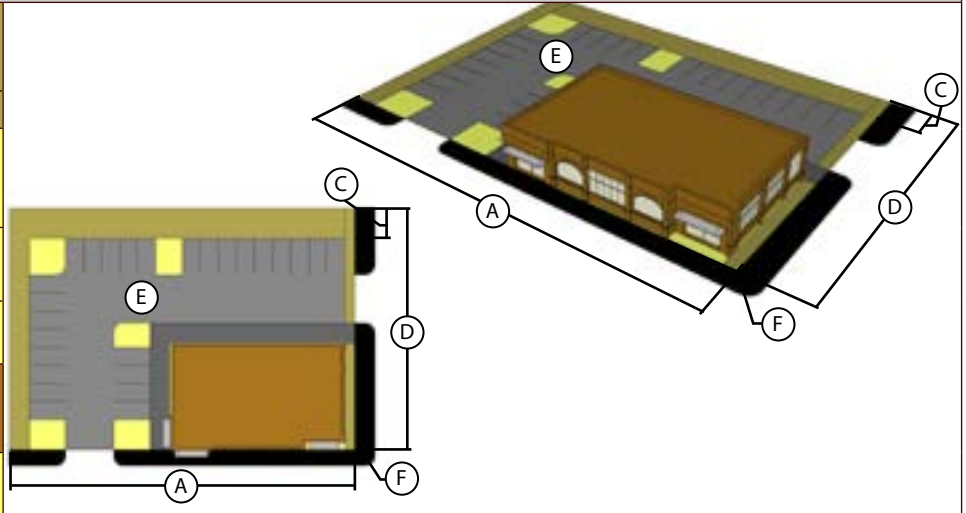

[a] 0' setbacks on attached buildings require a party wall meeting all building code standards and proper designation on the recorded plat.

TYPE NB6: SMALL CIVIC BUILDING

Lot Area	2,000 - 12,500 square feet	
Lot Frontage	25' - 100'	
Setbacks:	Front	10' to 35"
	Side	10% of lot frontage on each side, up to 10' maximum required setback
	Rear	15' 5' if alley loaded
Building Height	1 to 2.5 stories Up to 3.5 stories as conditional review	
Total Lot Coverage (max.)	70%	

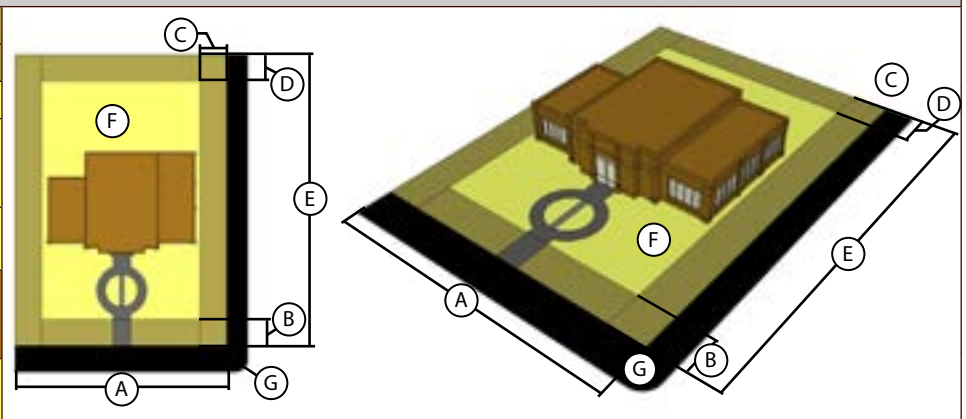

(A) Frontage	(D) Rear Setback	(G) Public Sidewalk
(B) Front Setback	(E) Depth	
(C) Side Setback	(F) Buildable Lot Area	

- e. **Permitted Uses.** The uses permitted in the NB district are specified in Table 5-1 as either "permitted" or "administrative" or "conditional."
- f. **Site and Building Design Standards.** Due to the more compact development pattern, and the important relationship and integration between uses sites and buildings in this district with adjacent neighborhoods, all uses in the NB district shall meet the Small-scale Mixed-use and Commercial Design Standards in Section 6.7. These standards shall apply to the design of buildings, sites, open spaces and streetscapes in order to create a walkable, mixed-use environment among this district and the various adjacent and supporting zoning districts.

5.4.2 CB – Community Business District

- a. **Intent.** The CB District is intended for Retail, Employment, Service and Civic uses that may serve a number of residential neighborhoods or other districts in meeting daily needs, discretionary needs, or other business functions. The district regulations are designed to encourage these uses, while also protecting the abutting and nearby areas.
- b. **Applicability.** The CB District is applicable in areas where moderate- or large-scale business uses are appropriate, specifically larger Mixed-use Commercial Activity Centers, Community/Regional Activity Centers, or Community Business areas of the Comprehensive Plan.
- c. **Context.** The total area of the district may be between 20 and 100 acres, with over 125,000 square feet of Retail uses for the entirety of the district (individual applications may be smaller). Larger and more intense applications within this range should be limited to Regional Centers located between 2 to 5 miles from other similar districts and smaller mixed-use and activity centers. This district should employ a well connected internal network to facilitate a park-once, walkable atmosphere and good internal circulation, and transitions to adjacent areas should be designed to minimize impacts on surrounding areas and transportation networks.
- d. **Lot and Building Standards.**

TYPE CB: COMMUNITY BUSINESS LOT AND BUILDING STANDARDS		
Lot Area		n/a
Lot Frontage		n/a
Setbacks: (Min)	Front	All buildings shall be set back 25' from all property lines adjacent to streets.
	Side	
	Rear	
Building Height		n/a
Maximum Coverage		85%

- e. **Permitted Uses.** The uses permitted in the CB district are specified in Table 5-1 as either “permitted” or “administrative” or “conditional.”
- f. **Site and Building Design Standards.**
 1. The Large-scale Commercial Design Standards in Section 6.8 may apply to buildings in this District, according to the provisions of that section.
 2. The City Council may elect to apply the Small-scale

Mixed-use and Commercial Design Standards in Section 6.7 as a condition to the rezoning to the CB District where it is located in an Activity Center designated in the Comprehensive Plan or a pedestrian-oriented environment is desired. In those instances, any conflict between Section 6.7 and this section shall be resolved in favor of the design guidelines in Section 6.7.

- 3. All other CB lots shall be subject to the General Commercial Design Standards in Section 6.9.

5.4.3 CBD – Central Business District

- a. **Intent.** The CBD is intended for a wide range of Retail, Employment, Service, Civic, Residential, and Public uses forming the financial, governmental, and cultural core of the community. A balance of old and new development as well as the preservation and restoration of noteworthy buildings is desired. The district regulations are designed to promote diverse activity, more intensive development, and continuation of the traditional urban form of downtown.
- b. **Applicability.** The CBD district is applicable to the central urban core of the City, specifically the CBD designation in the Comprehensive Plan.
- c. **Context.** It requires a tightly integrated network of diverse streets, which should be maintained and reinforced through any redevelopment.
- d. **Lot and Building Standards.**

TYPE CBD: CENTRAL BUSINESS DISTRICT LOT AND BUILDING STANDARDS		
Lot Area		n/a
Lot Frontage		n/a
Setbacks:	Front	0'
	Side	0'
	Rear	0'
Building Height		n/a
Maximum Coverage		100%

- e. **Permitted Uses.** The uses permitted in the CBD district are specified in Table 5-1 as either “permitted” or “administrative” or “conditional.”

5.4.4 MUR - Mixed-use Residential District

- a. **Intent.** The MUR District is intended for a mix of Residential, Retail, Service, Employment, and Civic uses where the predominant use will be Residential, with moderate or higher densities and a range of housing types. Non-residential uses should be limited to those that primarily support residential uses within the district. The district regulations are designed to allow a variety of housing types, and establish the necessary amenities to support higher-density urban neighborhoods.
- b. **Applicability.** The MUR District is applicable to areas where more urban, higher-density and walkable residential neighborhoods are desired and are appropriate with a high level of pedestrian and civic amenities, specifically areas designated Mixed-use Residential Emphasis in the Comprehensive Plan.
- c. **Context.** This district is also appropriate to establish transitions around Mixed-use Commercial Activity Centers and Community/Regional Commercial Activity Centers, or for achieving density along higher-traffic corridors and transit routes. Retail business should primarily support residential uses in or immediately adjacent to the neighborhood. The MUR district requires a highly connected transportation network within the district and surrounding areas, with smaller blocks and pedestrian-oriented streetscapes on the primary streets.
- d. **Lot and Building Standards.** The lot and buildings standards in the MUR district shall be a combination of those allowed in the NR-2 district and those allowed in the NB district.
- e. **Permitted Uses.** The uses permitted in the MUR district are specified in Table 5-1 as either “permitted” or “administrative” or “conditional.”
- f. **Site and Building Design Standards.** Due to the more compact development pattern, and the important relationship and integration between uses, sites and buildings in the MUR district, the following site and building standards shall apply:
 - 1. Urban loft, commercial or mixed-use lots and building types shall apply the Small-scale Mixed-use and Commercial Design Standards in Section 6.7.
 - 2. Residential lots and building types shall apply the Residential Design Standards in Section 6.6.

5.4.5 MUB – Mixed-use Business District

- a. **Intent.** The MUB District is intended for a diverse mix of Residential, Retail, Service, Employment and Civic uses integrated into a walkable compact development pattern. Non-residential uses may serve adjacent or nearby neighborhoods, as well as uses within the district, where transitions in the intensity of use and scale of buildings ensure compatibility with those neighborhoods. This district is also intended as an alternative format for moderate or larger scale commercial uses than that of the CB District. The district regulations are designed to allow a wide variety of compatible uses, and establish the necessary relationship between these uses, civic amenities, and the public realm.
- b. **Applicability.** The MUB District is applicable to areas where more intense development and diverse mix of uses is appropriate with a high level of pedestrian and civic amenities, specifically areas designated Mixed-use Commercial Emphasis, Mixed-use Commercial Activity Centers, and Community/Regional Commercial Activity Centers in the Comprehensive Plan.
- c. **Context.** The district should be located at least 1 to 1 ½ miles from similar districts or other activity centers. The district should primarily feature businesses that serve a typical target market area of ½ to 1½ miles for the majority of its on-site business. The MUB district requires a highly connected transportation network within the district and surrounding areas, with smaller blocks and pedestrian-oriented streetscapes on the primary streets.
- d. **Lot Standards.** The lot and buildings standards in the MUB district shall be a combination of those allowed in the NR-3 district and in the NB district, and the following lot standards specifically to accommodate larger commercial and mixed-use building sites in a compact, walkable setting:

ARTICLE 5 ZONING REGULATIONS

5.4 COMMERCIAL AND MIXED-USE DISTRICTS STANDARDS

TYPE MUB: LARGE MIXED-USE/ COMMERCIAL LOT AND BUILDING STANDARDS		
Lot Area	20,000 square feet minimum	
Lot Frontage	25' minimum	
Setbacks:	Front	0' to 20'
	Side	0' if partywall; 5' otherwise
	Rear	5' if alley; 15' otherwise
Building Height	3 stories Maximum	
	4 or more stories with conditional review	
Total Lot Coverage	90% maximum	

- e. **Permitted Uses.** The uses permitted in the MUB district are specified in Table 5-1 as either “permitted” or “administrative” or “conditional.”
- f. **Site and Building Design Standards.** Due to the more compact development pattern, and the important relationship and integration between uses, sites and buildings in the MUB district, the following site and building standards shall apply:
1. Urban loft, commercial or mixed-use lots and building types shall apply Small-scale Mixed-use and Commercial Design Standards in Section 6.7.
 2. Residential lots and building types shall apply the Residential Design Standards in Section 6.6.

5.4.6 MUE- Mixed-use Employment District

- a. **Intent.** The MUE District is intended a diverse mix of Employment, Light Industrial, and Civic uses integrated into a campus-like environment. Limited Retail, Service, and Residential uses may also support the overall plan for the area but not be a dominant factor in the land uses and design. All development shall be organized around public or common open spaces, including a well connected transportation network, that creates a unifying framework and character for the entire district, and which creates effective urban design and land use intensity transitions to surrounding development patterns.
- b. **Applicability.** The MUE District is applicable to areas where significant employment-based economic development opportunities exist and where improved pedestrian and civic amenities can coordinate development of compatible uses and designs, specifically areas designated Mixed-use Employment Campus or Industrial in the Comprehensive Plan.
- c. **Context.** The district can effectively be located as extensions of Activity Centers where designed with

appropriate connections to these areas. This can allow for slightly less stringent urban design standards for the MUE area, while providing a large daytime population within walking distance to help support the commercial activity in the adjacent centers. The MUE district requires a connected transportation network within the district and surrounding areas, with smaller blocks and pedestrian-oriented streetscapes on the primary streets, although centralized greenspace can serve as connections for non-motorized travel in a campus-type environment.

- d. **Lot Standards.** The lot and building standards in the MUE district shall be a combination of those allowed in the NB district, plus the following lot standards specifically to accommodate Employment and Light Industrial uses:

TYPE MUE: MIXED-USE EMPLOYMENT DISTRICT LOT AND BUILDING STANDARDS		
Lot Area	10,000 square feet Minimum	
Lot Frontage	80' – 250'	
	except no maximum for any lots fronting on a public or common open space or on a Parkway street type.	
Setbacks:	Front	25' Minimum 10' to 20' for lots fronting on a Boulevard, Avenue, or Pedestrian Street street type or fronting on any public or common open space.
	Side	10'
	Rear	20'
Building Height	3 stories Maximum	
	Up to 6 stories with conditional review and if fronting on public or common open space or on a Parkway street type.	
Total Lot Coverage	Minimum FAR .25	
	Maximum Lot Coverage 80% (excluding required open space)	

- e. **Permitted Uses.** The uses permitted in the MUE district are specified in Table 5-1 as either “permitted” or “administrative” or “conditional.”
- f. **Site and Building Design Standards.** Due to the unique development pattern and the important relationship and integration between uses, sites and buildings in the MUE district, the following site and building standards shall apply:
1. **Master Development Plan.** Any MUE district may be proposed according to an overall master plan that alters the Lot Standards, Site and Building Design Standards, and Transition Standards of this section,

provided the master development plan equally or better meets the intent of this district.

2. *Required Open Space / Common Area.* Each lot shall contribute to the overall public or common open space for the district according to the following:
 - (a) A minimum of 15% allocated Green, Plaza, Square or Courtyard, Pocket Park/Gateway types in Section 4.4
 - (b) A minimum of 20% is required if the Floor Area Ratio is above .75.
 - (c) A minimum of 20% is required if any portion of the open space is a Natural Area or Trail Corridor types in Section 4.4.
 - (d) Pocket Parks / Gateways shall be required at each location where an Arterial Street is intersected by a Collector Street or higher. These areas may count towards the required open space.
 - (e) A minimum 20' landscape buffer shall be required in addition to any required setbacks and open space when building heights are more than 1.5 times the height allowed in any adjacent or abutting residential use or zoning district.
3. *Building Elements.* All buildings shall include the following elements:
 - (a) *Primary Entrance Features.* All buildings shall have a primary entrance feature oriented towards the lot frontage. The entrance feature shall have direct pedestrian connections to the public streetscape or public or common open space with minimal interruptions by parking areas or driveways.
 - (b) *Horizontal Massing.* Any building with a front façade width greater than 150' shall have differentiated horizontal massing through any combination of the following:
 - (1) Differentiated structural bays every 25' to 50', demonstrated by a vertical expression line of trim or ornamental architectural elements that distinguish it from the rest of the facade;
 - (2) An intervening courtyard or plaza meeting the requirements of sub-section 6.6.6., resulting in no single portion of horizontal façade greater than 75';
 - (3) Off-sets in the façade of between 3' and 10', associated with enhanced landscape features or other similar civic amenities.
 - (c) *Façade Openings.* Each facade shall have openings at street level or on public or common open space according to the following:
 - (1) Retail and Service uses shall have between 60%

and 90% of all street-level facades between 2' and 10' above grade shall be transparent with views to the interior of the building. No window starting at a level of greater than 3.5' above the street level should be included in the calculation. Where the interior operation or program of the building warrants screening from the street, a closed display window of at least 2.5' in all dimensions may be substituted along up to 50% of the linear distance of the façade.

- (2) Employment and Light Industrial Uses located within 30' of any public right-of-way or any public or common open space, between 40% and 70% of all street-level facades between 2 and 10' above grade shall be transparent with views to the interior of the building. No window starting at a level of greater than 3.5' above the street level should be included in the calculation. Where the interior operation or program of the building warrants screening from the street, these portions of the building shall be located away from the street frontage or public and common open space.
4. *Site Screening.* Any delivery and service areas, external support equipment, site utility areas, or other similar high-impact elements of site and building design shall be subject to the following:
 - (a) All delivery or service areas and loading docks shall be located on a discrete façade, and internal to the block wherever possible.
 - (b) Any rooftop equipment shall be screened from view from the adjacent public streetscape or other public or common opens spaces by a parapet on flat roofs, or located on a discrete pitch for pitched roofs.
 - (c) Any service areas, loading docks, service equipment, or other site utility area that is visible from adjacent property or public right-of-way shall be screened with a landscape buffer.
 - (d) Any use that involves vehicle service bays on a primary or secondary façade shall be located on only secondary or support streets, shall have the service bay portion of the building set back at least 30' from the lot frontage, and shall not have service bays that front on Parkways, Boulevard, Avenue, or Pedestrian Street types.

5.4.7 BP – Business Park

- a. **Intent.** The Business Park (BP) district is intended to support small and large-scale industrial development while providing essential commercial services along regional transportation routes in an industrial park setting. The district integrates manufacturing, processing, research and development, and shipping activities in addition to retail, dining, and convenience stores to enhance functionality and appeal for businesses and employees.
- b. **Applicability.** The BP district is applicable to areas on the edge of the community that are intended to support large-scale industrial, manufacturing, shipping, research and development, and data center uses. The district is typically found close to major transportation routes, making commercial uses appropriate. The district shall contain not less than 320 acres of land (interrupted only by roads, railroads, highways and natural features (such as ridges and waterways). Specifically, large-scale areas within the future land use designations in the comprehensive plan of Community Business, Mixed-Use Employment, and Industrial – including Community/Regional Activity Centers. Areas currently designated Agricultural/Rural (either inside or outside of the Urban Service Boundary) may also be appropriate for this zone district if near to regional transportation routes and if development of the area extends appropriate infrastructure.
- c. **Context.** This district is most appropriate in areas with large acreage and access to major regional transportation infrastructure.
- d. **Lot and Building Standards.**

- e. **Permitted Uses.** The uses permitted in the BP district are specified in Table 5-1 as either “permitted” or “administrative” or “conditional.”
- f. **Site and Building Design Standards.** Due to the nature of development and context of this zone district, the following development standards shall apply to development in the BP zone.
 1. **Parking, Lot Access, and Circulation.** The minimum required Automobile Parking standards of UDC 6.2.4.a shall not apply to property within the BP district.
 2. **Landscaping.** Development shall comply with the standards of UDC 6.3, Landscaping Standards, with the following modifications:
 - (a) **Tree Requirement.** Instead of requiring tree points (UDC 6.3.4.a), every development shall plant one (1) tree for every one hundred (100) feet of street frontage. Trees shall be planted within 100’ of a right-of-way, within 15’ of a parking lot, or within 20’ of a building.
 - (b) **Shrub Substitution.** In lieu of planting trees, a developer may opt to plant six (6) shrubs as a substitute for each required tree.
 - (c) **Street Trees.** The Street Tree requirements of UDC 6.3.6 shall not apply.
 - (d) **Common Landscape Plan.** The submittal of a Common Landscape Plan and the standards within UDC 6.3.10 shall not apply.
 3. **Building Design Standards.** Any development not in the “Industrial Uses” category in Section 5.1.4, Table 5-1 shall comply with the design standards of UDC 6.9 (or UDC 6.8 if meeting the applicability of UDC 6.8).

TYPE BP: BUSINESS PARK DISTRICT LOT AND BUILDING STANDARDS		
Lot Area		n/a
Lot Frontage		n/a
Setbacks:	Front	All buildings shall be set back 25’ from all property lines adjacent to streets; 10 feet from all other internal property lines; and 25 feet from all property lines shared with another zone district.
	Side	
	Rear	
Building Height		n/a
Maximum Coverage		90%

5.5 Industrial Districts Standards

- 5.5.1 LI – Light Industrial District
- 5.5.2 HI – Heavy Industrial District

5.5.1 LI – Light Industrial District Standards

- a. **Intent.** The LI district is intended for environmentally controlled manufacturing or intensive employment uses that may have accessory commercial, service or office uses, but which cannot readily fit into other general business or mixed-use areas due to the nature or intensity of operations. The uses and building and site designs associated with uses in this district produce little or no impacts beyond the property lines.
- b. **Applicability.** The LI district is applicable to larger land areas that are capable of providing substantial buffers to adjacent sites, buildings, and land uses to minimize the potential for incompatible and negative impacts of uses in the district.
- c. **Context.** This district is most appropriate in areas with access to major regional transportation infrastructure, specifically areas designated Industrial in the Comprehensive Plan, and in limited applications within Mixed-use Employment Campus in the Comprehensive Plan. The district should be sized according to market demands and employment forecasts.
- d. **Lot and Building Standards.**

TYPE LI: LIGHT INDUSTRIAL LOT AND BUILDING STANDARDS		
Lot Area	n/a	
Lot Frontage	n/a	
Setbacks:	Front	All buildings shall be set back 25' from all property lines adjacent to streets.
	Side	
	Rear	
Building Height	n/a	
Maximum Coverage	85%	

- e. **Permitted Uses.** The uses permitted in the LI district are specified in Table 5-1 as either “permitted” or “administrative” or “conditional.”

5.5.2 HI – Heavy Industrial District Standards

- a. **Intent.** The HI district is intended for uses of very high intensity which should be isolated and buffered in order to protect the community and to ensure unimpeded operation of the use. These uses do not fit into other general business or mixed-use areas due to the nature or intensity of operations. The uses and building and site designs associated with uses in this district can produce impacts beyond the property lines, and the district should be remote from other differing and incompatible land uses.
- b. **Applicability.** The HI district is applicable to larger land areas that are remote from other differing or incompatible to minimize the potential for incompatible and negative impacts of uses in the district.
- c. **Context.** This district is most appropriate in areas with access to major regional transportation infrastructure, specifically areas designated Industrial in the Comprehensive Plan. The district should be sized according to market demands and employment forecasts and the inherent suitability of particular land areas to meet the intent of the district.
- d. **Lot and Building Standards.**

TYPE HI: HEAVY INDUSTRIAL LOT AND BUILDING STANDARDS		
Lot Area	n/a	
Lot Frontage	n/a	
Setbacks:	Front	40'
	Side	40'
	Rear	40'
Building Height	n/a	
Maximum Coverage	90%	

- e. **Permitted Uses.** The uses permitted in the HI district are specified in Table 5-1 as either “permitted” or “administrative” or “conditional.”

5.6 Special Purpose and Overlay Districts Standards

- 5.6.1 P – Public District
- 5.6.2 PUD – Planned Unit Development District
- 5.6.3 AD – Airport District
- 5.6.4 M – Military District
- 5.6.5 AHR – Airport Height Restriction Overlay
- 5.6.6 CHR – Capital Height Restriction Overlay
- 5.6.7 RUCAO – Restricted Use Control Area Overlay District
- 5.6.8 Support Services
- 5.6.9 UU – Urban Use Overlay District

5.6.1 P – Public District Standards

- a. **Intent.** The P district is intended primarily for public sites, buildings and uses where activities conducted provide service to the public, including educational facilities, recreational areas, and community service facilities. The sites, buildings, and uses in this district may create important identifying features of the neighborhoods and centers of the City, and should incorporate distinctive civic architecture and site design that emphasizes Cheyenne's regional architectural identity through character, quality, and authenticity where appropriate.
- b. **Applicability.** The P district is applicable to government buildings and uses in areas where it is necessary to support adjacent or nearby development with public services or facilities, and specifically the Parks and Open Space or Public and Quasi-public future land use categories in the Comprehensive Plan.
- c. **Context.** If property or a portion of property with this classification is sold or transferred to a nongovernmental entity, the classification shall be changed before the property can be utilized. The uses permitted in the P District may also be allowed as secondary or support uses in other zoning districts according to the standards of the other zoning districts, so it is not always necessary to rezone to the P District. However, the P District is applicable where the standards of those other districts conflict with the governmental function, and special consideration for government uses are necessary.
- d. **Lot and Building Standards.** Due to the variety of contexts in which the P District may apply, and the differing types of support activities that are appropriate in this district, the following lot types, building types and dimensions specified in the tables are permitted in the P district. Any building or site configuration in the P district that does not meet the following lot and building standards shall require a campus plan or master plan subject to the alternative standards process in sub-section h below:
 - 1. *Small Civic Building* (Type P-CV1). This type is intended for small-scale civic uses that fit within the surrounding development pattern and block structure and which provide support the immediately adjacent neighborhood and zoning districts. Examples include a neighborhood school, police or fire sub-station, neighborhood center or similar buildings.
 - 2. *Medium Civic Building* (Type P-CV2). This type is intended for medium scale civic uses that serve as prominent features and destinations of the surrounding neighborhood or zoning district. While they fit within the existing development pattern and block structure, they may occupy large portions of blocks and serve as landmarks for the area. Examples include larger schools, libraries, or community centers.
 - 3. *Prominent Civic Building* (Type P-CV3). This type is intended for large-scale civic uses that are regional destinations and due to their size and accessibility often require sites that may disrupt the surrounding block structure or development pattern. Designs that promote a "campus" layout assist with relating the building and sites to surrounding development and meeting the intent and applicability of this district. Examples include a large regional school, prominent public or government building, or major community event facility.
 - 4. *Open Space* (Type P-OS). This type is intended for parks and open space. Parks and open space shall be developed according to the Parks and Recreation Department standards, except that where these areas include buildings, facilities, or parking areas at least 25' surrounding any building or parking area shall meet the Landscape Standards in Section 6.3.
- e. **Permitted Uses.** The uses permitted in the P district are specified in Table 5-1 as either "permitted" or "administrative" or "conditional."
- f. **Accessory Uses.** Due to the public nature and Intent of the P District, accessory uses in the P district may be expanded

beyond those that are customarily incidental to other permitted uses. Any government owned and operated facility in the P District may also include additional accessory uses that are consistent with the public mission of the facility, are incidental to the primary purpose of the lot and building, and do not require any special design features that are inconsistent with the standards in this section. Examples include coffee shops or food concessions associated with public buildings.

g. **Performance Standards.** Due to the important civic function and support nature of the P District to other zoning districts, all uses in the P district shall meet the following performance standards:

1. Parking in the P District shall be provided according to the following:
 - (a) There is no minimum parking requirement. The City may require parking based on the most closely associated use requirements in Section 6.2, and parking maximums shall be according to the most closely associated use and requirements in Section 6.2.
 - (b) Any parking that is provided shall be designed according to the design standards in Section 6.2.
 - (c) Any parking that is provided should be designed for dual use, so that it accommodates parking needs in limited peak parking times but has appearances and function for other purposes during non-parking periods. Examples include: playgrounds designed for occasional parking; plazas or courts designed for occasional parking; stabilized turf surfaces; areas designed for special events such as concerts, festivals or markets which accommodate parking; or other similar dual purpose areas that emphasize the civic nature of sites in the P district.
 - (d) All sites in the P District should be located on or utilize street types that maximize on-street parking wherever possible. These street types will (1) calm traffic near parks or other civic activity areas and (2) minimize amount of site dedicated to surface parking.
2. Any fencing within 25' of the public right-of-way shall require:
 - (a) ornamental fencing, such as wrought iron, coated or colored chain link, or other designs intended to minimize the visibility of the fence; or

(b) include a Level 1 Buffer according to Section 6.3.5 of the Landscape Standards between the fence and the right-of-way.

3. All sites for the Small, Medium and Large Civic Buildings (Types P-CV1, P-CV2, and P-CV3) shall incorporate Civic Open Space meeting the standards of section 4.4 of the Unified Development Code.
 4. All sites shall meet the Landscape Standards in Section 6.3, except that Open Spaces (Types P-OS) shall meet the following:
 - (a) At least 25' surrounding any building or parking area shall meet the Landscape Standards in Section 6.3.
 - (b) All additional grounds shall be designed according to Section 4.4.1, 4.4.3, and 4.4.4 of the Unified Development Code and meet the Parks and Recreation Specifications for landscape and facility design.
 5. All buildings should incorporate the Regional Architectural Identity concepts in Section 2 of the Structure Plan of *PlanCheyenne* and submit details (research, precedents, etc.) demonstrating how these concepts are reflected in the proposed designs.
- h. **Alternative Standards Process.** The P District is intended to allow public and quasi-civic uses and site development that supports private development otherwise allowed in the UDC, all in conformance with the City's Comprehensive Plan. The P district is not intended to specifically regulate public uses such as fire stations, libraries, or community centers in any other manner than to generally ensure that they support the broader interests of the immediately adjacent areas and the community as a whole. The P district establishes basic standards that can facilitate this intent, but these standards are absent any specific site or context. Alternatively, when these facilities undergo a process with stakeholders to develop the preferred functions, usage, and site and building design, alternative standards may be approved in the City's discretion. Through that process, standards that are specific to a site or context may be developed. At a minimum, any alternative standards shall be consistent with the following:
1. Good civic design, including the Gateways and Landmarks concepts in *PlanCheyenne* (See Structure, Section 3), and the Regional Architectural Identity Concepts in *PlanCheyenne*. (See Structure, Section 2.)
 2. The Intent and Applicability of the P District, and the Intent of any abutting zoning districts for which this particular application of the P District is intended to support.

ARTICLE 5 ZONING REGULATIONS

5.6 SPECIAL PURPOSE AND OVERLAY DISTRICTS STANDARDS

TYPE P-CV1: SMALL CIVIC BUILDING

Lot Area		2,000 – 12,500 square feet
Lot Frontage		25' – 100'
Setbacks:	Front	10' to 35' [a]
	Side	7% of lot frontage on each side, up to 10' maximum required setback
	Rear	15' 5' if alley loaded
Building Height		1 to 2 stories Up to 3.5 stories as conditional review
Total Lot Coverage (max.)		80%

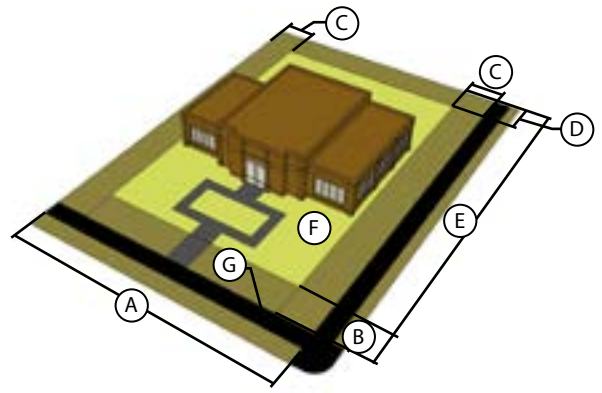
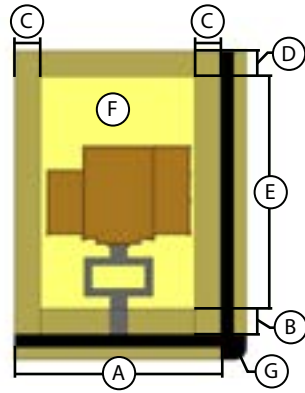

[a] Less than 25' only permitted for front or street-side setbacks with frontage along Boulevard, Avenue, or Pedestrian Street types according to Section 4.3 of these regulations.

TYPE P-CV2: MEDIUM CIVIC BUILDING

Lot Area		12,000 s.f. - 80,000 s.f.
Lot Frontage		300' maximum
Setbacks:	Front	25'; or 10' [a]
	Side	10% of lot frontage, up to 20' maximum requirement
	Rear	25' 10' alley loaded
Building Height		1 to 2 story Up to 3.5 stories as conditional review
Total Lot Coverage (max.)		80%

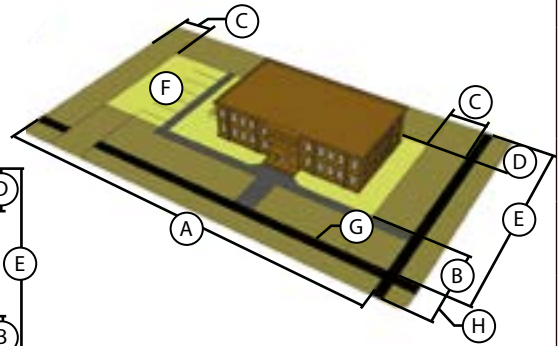
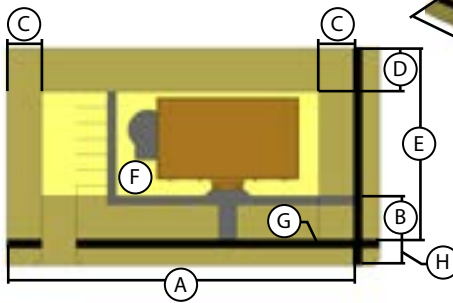

[a] Reduced minimum setback only permitted for front or street-side setbacks with frontage along Boulevard, Avenue, or Pedestrian Street types according to Section 4.3 of these regulations.

(A) Frontage	(D) Rear Setback	(G) Public Sidewalk
(B) Front Setback	(E) Depth	
(C) Side Setback	(F) Buildable Lot Area	

ARTICLE 5 ZONING REGULATIONS

5.6 SPECIAL PURPOSE AND OVERLAY DISTRICTS STANDARDS

TYPE P-CV3: PROMINENT CIVIC BUILDING

Lot Area		80,000 s.f. minimum
Lot Frontage		200' minimum 600' maximum [b]
Setbacks:	Front	50'; or 20' [a]
	Side	50'; or 20' [a]
	Rear	50' 20' if abutting alley
Building Height		3 story
Total Lot Coverage (max.)		80%

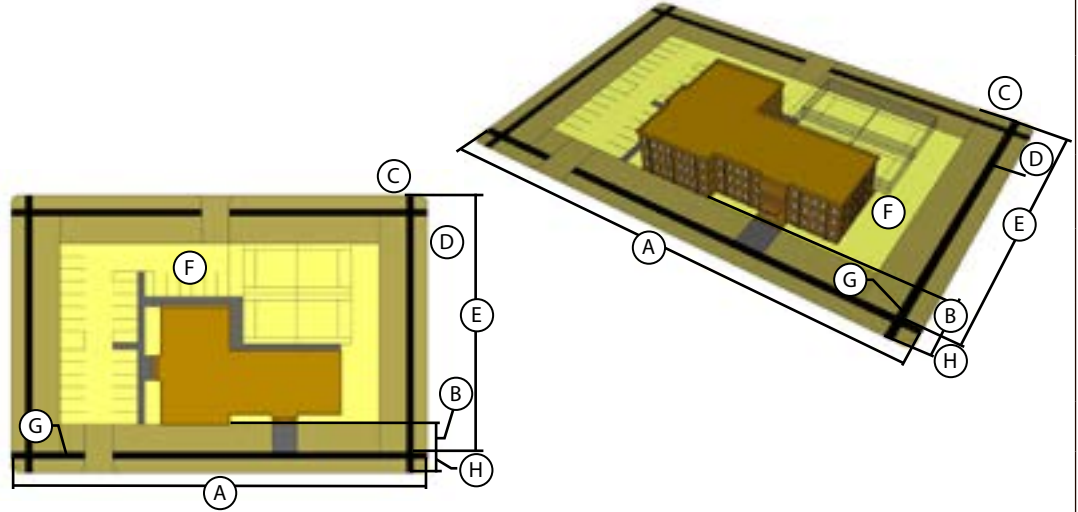

- [a] Reduced minimum setback only permitted for front or street-side setbacks with frontage along Boulevard, Avenue, or Pedestrian Street types according to Section 4.3 of these regulations.
- [b] Lot frontages larger than 600' are only permitted for Civic buildings that include a campus layout with mid-block pedestrian connections allowing permeability of the oversized block

(A) Frontage	(D) Rear Setback	(G) Public Sidewalk
(B) Front Setback	(E) Depth	(H) Public Right-of-way
(C) Side Setback	(F) Buildable Lot Area	

TYPE P-OS: OPEN SPACE

Lot Area		Subject to Section 4.4 and Parks and Recreation Specifications
Lot Frontage		Subject to Section 4.4 and Parks and Recreation Specifications
Setbacks: (min.)	Front	25'
	Side	25'
	Rear	25'
Building Height (max.)		2 stories
Total Lot Coverage (max.)		10%

3. Meet the Intent or Design Objectives of all other applicable site and building standards, or propose a unique and exemplary plan and design that equally or better meets the Intent and Design Objectives of those standards.

5.6.2 PUD – Planned Unit Development District

- a. **Intent.** A planned unit development shall permit flexibility and creativity in site and building design and location in accordance with an approved plan and specific ordinance, which shall be written in a manner as to prevent adverse impacts and protect the public health, safety and welfare. Design excellence and the provision of outstanding public amenity shall be considered when establishing development standards.
- b. **Applicability.** The planned unit development ordinance shall be considered the zoning ordinance for the property described in that ordinance.
- c. **Context.** A planned unit development designation is appropriate when at least one of the following is incorporated:
 1. Development of compatible land uses providing private and common spaces for recreation, circulation and open space;
 2. Conservation of natural features or development of desirable amenities. The use of woonerfs is encouraged

- for residential developments;
3. Creation of areas for mixed uses not ordinarily permitted together in other districts that are of benefit to the development and that are so designed as to prevent negative impacts to the surrounding areas. Industrial uses may be developed with other uses when the negative impacts are proven to be mitigated;
 4. Creation of large areas for a wide variety of retail uses, such as shopping centers and their associated developments, so that these uses can benefit from the combined planning standards.
- d. **Minimum District Area.** The minimum district area for planned unit developments is:
1. 2.0 acres for undeveloped land.
 2. 0.5 acres of redeveloping land
- Smaller areas may be considered when the proposed PUD clearly provides exceptional public benefits.
- e. **Sketch Plan.** Any applicant may submit a sketch plan detailing the applicant's intent. The plan may be forwarded to the commission for review only. Comments shall not be construed as an approval of any sketch plan. Sketch plans and documents should address the appropriate items listed in sub-section f. The sketch plan may also be used for the conceptual planning meeting required by Section 2.2.2.
- f. **Preliminary Plan.** An applicant shall submit an application for a preliminary development plan containing concepts, standards and phasing for the full build out of the subject property according to procedures and criteria in Article 2 and draft ordinance for approval. Any ordinance rezoning property to the PUD district shall include the following according to the preliminary development plan, or as otherwise specified in the ordinance:
1. Uses by right and location;
 2. Uses permitted by Board approval and location;
 3. Lot and building standards, specifying where they are different from the most similar base zoning district requirements. Lot and building standards shall include the following for each different lot and building type in the plan:
 - (a) Lot frontage;
 - (b) Lot size;
 - (c) Lot coverage;
 - (d) Building height; and
 - (e) Setback, build-to lines, or other building orientation specifications;
4. Building design standards, specifying where they are different from what would be required by Section 6.6 for residential buildings and lots, 6.7 for small-scale commercial buildings and lots, or 6.8 for large-scale commercial buildings or lots;
 5. Landscape, buffering and screening requirements, specifying where they are different from what would be required by Section 6.3;
 6. Common open space or facilities and design types, where they are different from what would be required by Section 4.4;
 7. Signage requirements and regulations, specifying where they are different from what would be required by Section 6.5;
 8. Parking requirements, specifying where they are different from what would be required by Section 6.2;
 9. Development performance standards;
 10. Proposed ownership of common facilities;
 11. A statement on how proposed deviations from otherwise required standards support the proposed plan, and result in design excellence and outstanding public amenity that is otherwise not allowable under general zoning standards; and
 12. Any other requirements and restrictions that meet the intent of this district.
- g. **Final Plan.** Any development in the PUD district shall require a submittal of a Final Plan according to the procedures and criteria in Section 2.2.2.
- h. **Amendments.** Amendments proposed in the Final Plan shall only be permitted as specified within the bounds of the preliminary development plan or ordinance approving the PUD, or as permitted by Administrative Adjustment according to the procedures and criteria in Section 2.3.4. All other amendments shall be processed as an amendment to the zoning and preliminary development plan.
- i. **Existing Planned Unit Developments.** All planned unit developments which have been approved and are shown on the zoning maps at the effective date of the ordinance codified in this Title shall be developed in the manner in which they were originally approved. All existing planned unit development ordinances and resolutions shall be a supplement to this code and shall be on file with the Development Office and the City Clerk. Any planned unit developments shown on the zoning maps that do not have a specific planned unit development ordinance or resolution shall have an ordinance approved by the City

Council, prior to any future development or changes of use within that planned unit development district.

5.6.3 AD – Airport District Standards

- a. **Intent.** The AD district is intended to provide for logical development of the airport property for an airport and related facilities and uses.
- b. **Applicability.** The AD district is applicable to areas owned by the Airport Board and the state of Wyoming at the Cheyenne Regional Airport.
- c. **Context.** In addition to the general district requirements, prior to the initial development of any land in this district located north of the residential area bounded on the west by Morrie Avenue and on the east by Converse Avenue a hearing shall be required on the development plan by the Airport Board with approval of the development plan by the City Council. After Council approval, the site plan procedures will be used.
- d. **Lot and Building Standards.**

TYPE AD: AIRPORT DISTRICT LOT AND BUILDING STANDARDS		
Lot Area	n/a	
Lot Frontage	n/a	
Setbacks:	Front	25'
	Side	25'
	Rear	25'
Building Height	n/a	
Maximum Coverage	85%	

- e. **Permitted Uses.** The uses permitted in the AD district are specified in Table 5-1 as either “permitted,” “administrative” or “conditional.”
- f. **Site and Building Design Standards.** All uses in the AD district are subject to site plan review. To further protect the public health, safety and welfare as well as preserve this distinct for airport and other airport development uses, these additional restrictions apply:
 - 1. **Liquid and Solid Wastes.** Storage of animal, vegetable or other wastes which attract insects, rodents, or birds or otherwise create a health hazard shall be prohibited.
 - 2. **Discharge Standards.** There shall be no emission of

smoke, fly ash, dust, vapor, gases or other forms of air pollution that may cause nuisance or injury to human, plant or animal life, or to property, or that may conflict with any present or planned operations of the airport.

- 3. **Lighting.**
 - (a) Sign lighting shall not project directly into an adjoining residential district.
 - (b) Unless necessary for safe and convenient air travel, sign lighting and exterior lighting shall not project directly into the runway, taxiway or approach zone.
- 4. **Glare and Electromagnetic Interference.**
 - (a) Building materials shall not produce glare which may conflict with present or planned operations of the airport.
 - (b) No use may produce electromagnetic interference which may conflict with any present or planned operations of the airport.

5.6.4 M – Military District Standards

- a. **Intent and Context.** The M district consists of property owned and controlled by the United States Government and further known as F.E. Warren AFB. These lands are not subject to local regulation, as they are under the jurisdiction of the federal government. If the property or portions of the property with this classification are sold or transferred to any entity other than the United States Government, the district classification shall be changed before the property can be utilized.

5.6.5 AHR - Airport Height and Use Restrictive Overlay District

- a. **Intent.** The AHR district has been created because an obstruction to airspace has the potential for endangering the lives and property of users of the Cheyenne Airport, and property or occupants of land in its vicinity. That obstruction may affect existing and future instrument approach minimums of the Cheyenne Airport. The obstruction may reduce the size of areas available for the landing, takeoff and maneuvering of aircraft, thus tending to destroy or impair the utility of the Cheyenne Airport and the public investment in that facility.
- b. **Definitions.** The following definitions are specific to this district and are used to clarify the provisions of this district.

“Airport” means an area of land set aside for the landing and taking off of aircraft, and utilized or to be utilized in the interest of the public for such purposes and commonly known as the Cheyenne Airport.

“Airport elevation” means the highest point of an airport’s usable landing area measured in feet above mean sea level. This is six thousand one hundred fifty-six (6,156) feet above sea level for the Cheyenne Airport.

“Airport operator” means the Cheyenne Airport Board whose responsibility it is to maintain and operate the airport.

“Approach surface” means a surface longitudinally centered on the extended runway centerline, extending outward and upward from the end of the primary surface and at the same slope as the approach zone height limitation slope set forth in Sub-section d. The perimeter of the approach surface coincides with the perimeter of the approach zone.

“Approach, Transitional, Horizontal and Conical Zones.” These zones apply to the area under the approach, transitional, horizontal and conical surfaces defined in Part 77 of the Federal Aviation Regulations as set forth in Sub-section c.

“Conical surface” means a surface extending outward and upward from the periphery of the horizontal surface at a slope of twenty to one (20:1) for a horizontal distance of four thousand (4,000) feet.

“Hazard to air navigation” means an obstruction determined to have a substantial adverse effect on the safe and efficient utilization of the navigable airspace.

“Height” means for the purpose of determining the height limits in all districts set forth in this Section, the datum shall be mean sea level elevation unless otherwise specified.

“Horizontal surface” means a horizontal plane one hundred fifty (150) feet above the established airport elevation, the perimeter of which coincides with the perimeter of the horizontal zone. This is six thousand three hundred six (6,306) feet above the mean sea level for the Cheyenne Airport.

“Larger than utility runway” means a runway that is constructed for and intended to be used by propeller-driven aircraft of greater than twelve thousand five hundred (12,500) pounds maximum gross weight and jet-powered aircraft.

“Nonprecision instrument runway” means a runway having

an existing instrument approach procedure utilizing air navigation facilities with only horizontal guidance, or area-type navigation equipment, for which a straight-in nonprecision approach procedure has been approved or planned.

“Obstruction” means any structure, growth or other object, including a mobile object, which exceeds a limiting height set forth in Sub-section d.

“Precision instrument runway” means a runway having an existing instrument approach procedure utilizing an instrument land system (ILS) or a precision approach radar (PAR). It also means a runway for which a precision approach system is planned and is so indicated on an approved airport layout plan or any other planning document.

“Primary surface” means a surface longitudinally centered on a runway. When the runway has a specially prepared hard surface, the primary surface extends two hundred (200) feet beyond each end of that runway; but when the runway has no specially prepared hard surface, or planned hard surface, the primary surface ends at each end of that runway. The width of the primary surface of a runway will be that width prescribed in Part 77 of the Federal Aviation Regulations for the most precise approach existing or planned for either end of that runway and set forth in Sub-section c. The elevation of any point on the primary surface is the same as the elevation of the nearest point on the runway centerline.

“Runway” is a defined area on an airport prepared for landing and take-off of aircraft along its length.

“Structure” means an object, including a mobile object, constructed or installed by a person, including, but without limitation, buildings, towers, smokestacks, earth formations and overhead transmission lines. Transitional Surfaces. These surfaces extend outward at ninety-degree angles to the runway centerline and the runway centerline extended at a slope of seven feet horizontally for each foot vertically (7:1) from the sides of the primary and approach surfaces to where they intersect the horizontal and conical surfaces. Transitional surfaces for those portions of the precision approach surfaces, which project through and beyond the limits of the conical surface, extend a distance of 5,000 feet measured horizontally from the edge of the approach surface and at ninety-degree angles to the extended runway centerline.

“Tree” means any object of natural growth.

“Utility runway” means a runway that is constructed for and intended to be used by propeller-driven aircraft of twelve thousand five hundred (12,500) pounds maximum gross weight and less.

“Visual runway” means a runway intended solely for the operation of aircraft using visual approach procedures with no straight-in instrument approach procedure.

c. **Airport operations zones.** In order to carry out the provision of this code, there are created and established certain zones which include all of the land lying beneath the approach surfaces, transitional surfaces, horizontal surfaces, and conical surfaces as they apply to the Cheyenne Airport. Such zones are shown on the Cheyenne Airport zoning map and are adopted by reference and declared to be a part of this Title. This map is maintained at the offices of the Airport Board. An area located in more than one of the following zones is considered to be only in the zone with the more restrictive height limitation. The various zones are hereby established and defined as follows:

1. Runway Larger than Utility with a Visibility Minimum Greater than Three-Quarter-Mile Nonprecision Instrument Approach Zone (Runway 12/30). The inner edge of this approach zone coincides with the width of the primary surface and is five hundred (500) feet wide. The approach zone expands outward uniformly to a width of three thousand five hundred (3,500) feet at a horizontal distance of ten thousand (10,000) feet from the primary surface. Its centerline is the continuation of the centerline of the runway.
2. Precision Instrument Runway Approach Zone (Runway 8/26). The inner edge of this approach zone coincides with the width of the primary surface and is one thousand (1,000) feet wide. The approach zone expands outward uniformly to a width of sixteen thousand (16,000) feet at a horizontal distance of fifty thousand (50,000) feet from the primary surface. Its centerline is the continuation of the centerline of the runway.
3. Transitional Zones. The transitional zones are the areas beneath the transitional surfaces.
4. Horizontal Zone. The horizontal zone is established by swinging arcs of ten thousand (10,000) feet radius from the center of each end of the precision instrument runway (Runway 8/26) and connecting the adjacent arcs by drawing lines tangent to those arcs. The horizontal zone does not include the approach and transitional zones.

5. Conical Zone. The conical zone is established as the area that commences at the periphery of the horizontal zone and extends outward and upward therefrom at 20:1 for horizontal distance of four thousand (4,000) feet.

d. **Airport zone height limitations.** Except as otherwise provided in this Title, no structure shall be erected, altered, or maintained and no tree shall be allowed to grow in any zone created by this Title to a height in excess of the applicable height herein established for such zone. Where an area is covered by more than one height limitation, the more restrictive will prevail. The applicable height limitations are established for each of the zones in question as follows:

1. Runway Larger than Utility with a Visibility Minimum Greater than Three-Quarter-Mile Non-Precision Instrument Approach Zone. Runway 12 slopes twenty (20) feet outward for each foot upward (20:1) beginning at the end of and at the same elevation as the primary surface and extending to a horizontal distance of 10,000 feet along the extended runway centerline. Runway 30 slopes thirty-four (34) feet outward for each foot upward (34:1) beginning at the end of and at the same elevation as the primary surface and extending to a horizontal distance of ten thousand (10,000) feet along the extended runway centerline.
2. Precision Instrument Runway Approach Zone. Runway 8 slopes twenty (20) feet outward for each foot upward (20:1) beginning at the end of and at the same elevation as the primary surface and extending to a horizontal distance of ten thousand (10,000) feet along the extended runway centerline. Runway 26 slopes fifty (50) feet outward for each foot upward (50:1) beginning at the end of and at the same elevation as the primary surface and extending to a horizontal distance of ten thousand (10,000) feet along the extended runway centerline; thence slopes upward (40:1) to an additional horizontal distance of forty thousand (40,000) feet along the extended runway centerline.
3. Transitional Zone. The transitional zone slopes seven feet outward for each foot upward (7:1) beginning at the sides of and at the same elevation as the primary surface, and extending to a height of one hundred fifty (150) feet above the airport elevation, which is six thousand one hundred fifty-six (6,156) feet above mean sea level. In addition to the foregoing, there are established height limits sloping seven feet outward

for each foot upward (7:1) beginning at the sides of and at the same elevation as the approach surface, and extending to where they intersect the conical surface. Further, where the precision instrument runway approach zone projects through and beyond the conical zone, there are established height limits sloping seven feet outward for each foot upward (7:1) beginning at the sides of and at the same elevation as the approach surface, and extending to a horizontal distance of five thousand (5,000) feet measured at ninety-degree angles to the extended runway centerline.

4. Horizontal Zone. The horizontal zone is established at one hundred fifty (150) feet above the airport elevation or at a height of six thousand three hundred six (6,306) feet above mean sea level.
5. Conical Zone: The conical zone slopes twenty (20) feet outward for each foot upward (20:1) for four thousand (4,000) feet beginning at the periphery of the horizontal and at one hundred fifty (150) feet above the airport elevation and extending to a height of three hundred fifty (350) feet above the airport elevation.

e. **Airport zone use restrictions.** Airport zone use restrictions are as follows:

1. Notwithstanding any other provision of this Title, no use may be made of land or water within any zone established by this Title in such a manner as to create electrical interference with navigational signals or radio communication between the airport and aircraft, make it difficult for pilots to distinguish between airport lights and others, result in glare in the eyes of pilots using the airport, impair visibility in the vicinity of the airport, create bird strike hazards, or otherwise in any way endanger or interfere with the landing, takeoff, or maneuvering of aircraft intending to use the airport.
2. No place of public assembly shall be permitted in the following portions of the airport approach zones:
 - (a) Within three thousand two hundred (3,200) feet from the end of Runway 8;
 - (b) Within ten thousand (10,000) feet from the end of Runway 26;
 - (c) Within three thousand (3,000) feet from the end of Runway 12;
 - (d) Within three thousand (3,000) feet from the end of Runway 30;
 - (e) Within three thousand four hundred twenty

(3,420) feet from the end of Runway 16;

- (f) Within two thousand eight hundred (2,800) feet from the end of Runway 34. (Zoning Ordinance, Appx. A § 49.050)

f. **Nonconforming uses.** In addition to provisions in Article 1, these special provisions for nonconforming uses will also apply. In the event of a conflict between the provisions, the more restrictive will prevail.

1. Regulations Not Retroactive. The regulations prescribed by this Title shall not be construed to require the removal, lowering, or other change or alteration of any structure or tree not conforming to the regulations as of March 1, 1989 or otherwise interfere with the continuance of nonconforming use. Nothing contained in this section shall require any change in the construction, alteration or intended use of any structure, the construction or alteration of which was begun prior to March 1, 1989 and is diligently prosecuted.
2. Marking and Lighting. Notwithstanding the preceding provision of this section, the owner of any existing nonconforming structure or tree is hereby required to permit the installation, operation and maintenance thereon of such markers and lights as shall be deemed necessary by the Cheyenne Airport Board to indicate to the operators of aircraft in the vicinity of the airport the presence of such airport obstruction. Such markers and lights shall be installed, operated and maintained at the expense of the Cheyenne Airport Board.
3. Nonconforming Uses Abandoned or Destroyed. Whenever the City Engineer Director determines that a nonconforming structure has been abandoned or more than 80 percent torn down, physically deteriorated or decayed, no permit for reconstruction shall be granted that would allow such structure to exceed the applicable height limit or otherwise deviate from the zoning regulations. A nonconforming structure that is abandoned or more than 80 percent deteriorated shall be torn down within one year of the Director's determination, unless a permit for reconstruction is applied for within that one-year period. A nonconforming tree that is more than 80 percent deteriorated or decayed shall be removed by the landowner or the Cheyenne airport board, at the landowner's option, within one month of written notice of that action.

ARTICLE 5

ZONING REGULATIONS

5.6 SPECIAL PURPOSE AND OVERLAY DISTRICTS STANDARDS

g. **Permit applications--Review.** In order to meet the requirements of Section 5.6, the Director shall refer building permit applications to the Cheyenne Airport Board for review and comment in cases where the proposed buildings or uses may be restricted or limited by the provisions of this Section.

5.6.6 CHR – State Capitol Height Restrictive Overlay District

a. **Intent and Context.** Special height restrictions shall be required in areas surrounding the State Capitol building. These height restrictions shall be as follows.

b. **Original City Blocks.** For the purposes of this Section, the land described by blocks shall be construed to be the blocks in the original City plat prior to any replats. Replats of all or portions of these blocks shall also be subject to these height restrictions.

c. **Building Elevation.** The building height as defined in this Title and the ground elevation above mean sea level shall be determined by the City Engineer and are based on the City of Cheyenne datum.

1. Within the following original City blocks, building elevations shall not exceed six thousand one hundred forty-five (6,145) feet: Blocks: 079, 080, 106, 107, 108, 109, 139, 140, 141, 142, 143, 144, 167, 168, 169, 170, 171, 172, 201, 202, 203, 204, 205, 206.
2. Within the following original City blocks, building elevations shall not exceed six thousand one hundred fifty-six (6,156) feet: Blocks: 044, 045, 046, 047, 077, 078, 081, 082, 104, 105, 110, 111, 138, 145, 166, 173, 200, 207, 228, 229, 230, 231, 232, 233, 234, 235.
3. Within the following original City blocks, building elevations shall not exceed six thousand one hundred seventy-four (6,174) feet: Blocks: 016, 017, 018, 019, 043, 048, 076, 083, 103, 112, 137, 146, 165, 174, 199, 208, 227, 236, 261, 262, 263, 264, 265, 266, 267, 268, 269, 270.

5.6.7 Restricted Use Control Area Overlay District (RUCAO)

a. **Intent and Context.** The restricted use control area overlay (RUCAO) district is intended to establish long-term use restrictions for property in the City on which soil is contaminated. Use restrictions are applied to protect the community from contact with contaminants.

Any modification to any RUCAO, including removal of the RUCAO designation, requires compliance with the Wyoming Environmental Quality Act, Title 35, Article 16 of the Wyoming Statutes and coordination with the Wyoming Department of Environmental Quality (WDEQ).

b. **Statutory Authority.** The provisions of this Section are based, in part, on Article 16 of the Wyoming Environmental Quality Act, voluntary remediation of contaminated sites.

c. **Petition Required--Procedure.**

1. The owner of a site who proposes long-term restrictions on the use of the site shall submit a petition, as required by Article 16 (Wyo. Stat. Section 35-11-1609(a)) of the Wyoming Environmental Quality Act, to the Planning and Development Department.
2. A use control area may be created or modified only upon submission of a petition by the owner of a parcel of real property accepted as a "site" in the WDEQ voluntary remediation program (VRP). The owner must comply with notice and public hearing requirements as provided in subsection d of this section, and shall include only the site.
3. Upon submission of a petition for long-term use restrictions, the owner shall give written notice of the petition to all surface owners of record of land contiguous to the site. The owner shall also publish notice of the petition and a public hearing once per week for four consecutive weeks in a newspaper of general circulation in Cheyenne, Wyoming. The notice shall identify the property, generally describe the petition and proposed use restrictions, direct that comments may be submitted to the Planning and Development Department, and provide the date, time and place of the Planning Commission meeting at which the petition will be heard and discussed. The public hearing shall be held no sooner than 45 days after the first publication of the notice.
4. The Planning Commission can modify the petition, if warranted, only during the public hearing, and with WDEQ and site owner concurrence. If the petition is found to be acceptable, the Planning Commission shall recommend the approval of the petition and certify the petition to the City Council. The governing body shall adopt or reject the petition. If the petition is rejected or required to be modified, it shall be returned to the planning commission and owner (who shall confer with the WDEQ) for further review. However, any modification shall be made in accordance with

ARTICLE 5 ZONING REGULATIONS

5.6 SPECIAL PURPOSE AND OVERLAY DISTRICTS STANDARDS

this sub-section including public notice and hearing. If the petition is to be accepted, it shall be approved by ordinance and the overlay designation placed on the official zoning map of the City. The governing body will stipulate and define the specific boundary of the overlay zone, as presented in the petition.

5. The petition shall be finally approved or denied by the governing body within 180 days after the petition has been received by the Planning Commission. The owner and the governing body may agree to extend the time period in which the governing body is to vote upon the petition. The governing body may condition its approval upon the owner's subsequent filing of the determination by the WDEQ director that a remedy can be selected that meets the requirements of Wyo. Stat. Section 35-11-1605 and is consistent with the owner's petition. (Ord. 3598 § 1 (part), 2004)
- d. **Petition--Contents.** Petitions submitted pursuant to sub-section c. shall contain the following documentation:
 1. Introduction: Description of the location and ownership of the site (cross-referenced to an attached map and legal description of the site); size of the site; the source of contamination; and the date the site was accepted into the VRP.
 2. Data: A summary of all data collected, as required by the preliminary remediation agreement, which indicates that the site exceeds cleanup standards necessary to support unrestricted use.
 3. Draft Remedy or Remedies to be Proposed in the Remediation Agreement: Description of the proposed land use for the site and a summary of the remedy or remedies to be used to support the land use. Description of how the remedy will be accomplished and how the outcome of the remedy implementation relates to the request for a RUCAO designation.
 4. Justification for the Use Control Area: Explanation of what would be necessary to make the site suitable for unrestricted use and why it is not feasible to implement this remedy, including an analysis of the amount of effort needed to attain unrestricted use versus the proposed use.
 5. Prohibited Future Uses: A list of the uses which will be prohibited if the RUCAO is established.
 6. Public Notice Requirements: A summary of the public notice procedures to be followed regarding the petition.
 7. Remediation Agreement Acknowledgment: Insertion of the following sentence into the petition: "The site will be subject to a remediation agreement between the owner

and the Wyoming Department of Environmental Quality."

- e. **Amendments and Changes.** Any modification to the RUCAO shall follow the process described in this Section.

5.6.8 Support Services

- a. **Intent.** The Support Services (SS) district is intended for government owned land that is typically accessible to the general public with services supporting the mission of the military and members of the military. This may include educational, recreational, research, retail, office, residential, and industrial uses.
- b. **Applicability.** The SS district is applicable to government owned land in Military/Federal areas of the Comprehensive Plan.
- c. **Context.** This district is most appropriate in areas with access to major regional transportation infrastructure and in close proximity to Francis E. Warren Air Force Base or other federal facilities.
- d. **Lot and Building Standards.** The following lot and building standards shall apply:

TYPE SS: SUPPORT SERVICE DISTRICT LOT AND BUILDING STANDARDS		
Lot Area		n/a
Lot Frontage		n/a
Setbacks (Minimum):	Front	0'
	Side	0'
	Rear	0'
Building Height		n/a
Maximum Coverage		90%

- e. **Permitted Uses.** The uses permitted in the SS district are specified in Table 5-1 as either "permitted" or "administrative" or "conditional."
- f. **Site and Building Design Standards.** The following development standards shall supplement those contained in this code. Wherever possible, and if not exempted, development shall comply with the standards of Article 5 and Article 6 of the UDC, and the standards of this section; however, in the event of a direct conflict, the standards of this section shall govern.
 1. *Parking, Lot Access, and Circulation.* The minimum

ARTICLE 5 ZONING REGULATIONS

5.6 SPECIAL PURPOSE AND OVERLAY DISTRICTS STANDARDS

required Automobile Parking standards of UDC 6.2.4.a shall not apply to property within the SS district.

2. **Sign Allowances.** The following shall supplement the standards of UDC 6.5.4: "For the purposes of the SS district, sign allowances shall be calculated on a per tenant/use basis instead of lot or acreage."
3. **Commercial Building Design Standards.** Development shall comply with the standards of UDC 6.9 with the following modifications:
 - (a) **Detail Features.** Office, research, technology, and military-related development shall be exempt from the Detail Features requirements of UDC 6.9.
 - (b) **Building Materials.** Office, research, technology, and military related development shall be exempt from the Building Materials requirements of UDC 6.9. Commercial and mixed use buildings shall be constructed according to the following material standards as identified in Table 6-21 of UDC 6.9.4.e:
 - (1) **Primary Materials.** All buildings shall have one primary material covering at least 20% of the building façades;
 - (2) **Secondary Materials.** Buildings may have a secondary material covering up to 75% of the façades;
 - (3) **Accent Materials.** Buildings shall have at least on accent material covering at least 5% of the building façade.
 - (c) **Alternatives.** Minor deviations from the standards may be evaluated by the Director to meet the intent of the commercial building design standards of the UDC through an alternative design to allow a site specific plan that is qualitatively equal to or better than the strict application of a design standard specified in this Code. This procedure is not intended as a substitute for a variance or administrative adjustment or a vehicle for relief from standards of this Code. To grant an alternative design, the director shall find either:
 - (1) The proposed alternative design achieves the intent of the subject design standard to the same or better degree than the subject standard; achieves the goals and policies of PlanCheyenne to the same or better degree than the subject standard; and results in benefits to the community that are equivalent to or better than compliance with the subject standard; or
 - (2) The required improvement would be ineffective because of location, topographic,

or site constraints while the alternative design can accommodate site-specific issues.

3. **Landscaping.** Development shall comply with the standards of UDC 6.3, Landscaping Standards, with the following modifications:
 - (a) **Percentage of Living Materials.** Required landscape area, including the internal landscaping area, screening and buffering areas, landscaped setback and parking strips, shall consist of a minimum 65% ground cover by living grass or other plant materials based on mature size of vegetation. The remaining required landscape area may be covered with bark, wood chips, rock, stone, or similar materials.

5.6.9 UU – Urban Use Overlay District

- a. **Intent.** The UU overlay district is intended for Urban and Infill Development. The UU district is intended to transition and step down from the urban core and other urban areas of Cheyenne into the surrounding neighborhoods.
- b. **Applicability.** The UU overlay district is applicable to various lands envisioned for urban development. A base zone district of P, MUB, or MUR must be in place in order for the UU overlay to apply.
- c. **Context.** This district is most appropriate in areas with existing or future urban development patterns.
- d. **Lot and Building Standards.** The following lot and building standards shall apply and replace the lot standards for the underlying district for all uses:

TYPE UU: URBAN USE OVERLAY LOT AND BUILDING STANDARDS		
Lot Area	No minimum or maximum	
Lot Frontage	n/a	
Setbacks:	Front	0' minimum, 10' maximum, or context of surrounding properties
	Side	0' minimum, no maximum side setback 0' minimum, 10' maximum on street side setbacks 5' minimum and 15' maximum on lot lines fronting and adjacent to the Reed Avenue ROW
	Rear	0'
Building Height	Buildings shall not have a pinnacle height that exceeds an elevation of 6,150' in the West Edge District.	
Maximum Coverage	90%, 100% if site provides a street furnishing or projection as listed in 5.6.9.f.4.	

e. **Permitted Uses.** This section shall apply when the underlying zoning district is P, MUR or MUB.

1. *Permitted Uses*

(a) All uses allowed in the underlying zoning district are allowed as indicated in Table 5-1, except as specifically prohibited or allowed in subsections 5.6.9.e.2 below.

2. *Prohibited Uses:*

The following Uses are prohibited in the UU overlay base zone districts:

- (a) Impoundment Yards
- (b) Outdoor Sale
- (c) Automobile Service Repair
- (d) Automobile Service Station – Limited and General

3. *Allowed by Conditional Use in all UU overlay base zone districts:*

- (a) Moderate Industrial

f. **Site and Building Design Standards.** The following development standards shall supplement those contained in this Code. Wherever possible, and if not exempted, development shall comply with the standards of Article 5 and Article 6 of the UDC, and the standards of this section; however, in the event of a direct conflict the standards of this section shall govern.

1. **Parking, Lot Access and Circulation.** *The minimum required Automobile Parking standards of UDC 6.2.4.a shall not apply to property within the UU district.*

(a) **Bicycle Parking.** All new development or changes of use that require a Site Plan per section UDC 2.2.3.b. shall provide 2 bicycle parking spaces per 2,000 square feet of gross floor area.

- (1) Required bicycle parking is permitted in the ROW so long as the parking does not interfere with the 5' required ADA pedestrian zone.
- (2) Applicant will have the ability to provide cash-in-lieu for bicycle parking to the shared biking facilities fund.

2. **Commercial Building Design Standards.**

Development shall comply with the standards of UDC 6.7. with the following modifications:

(a) **West Edge Area.** Properties included in the UU overlay district that fall within the West Edge district, located between 24th Street and the Union Pacific Railroad from north to south and

Carey Avenue to Missile Drive from east to west, shall incorporate the design standards of UDC 6.7; or, as alternative compliance, shall incorporate the design guidelines from Chapter 5 of the 2016 West Edge Area Wide Plan into any development that requires a Site Plan Review per UDC 2.2.3.b.

(b) **Adaptive Reuse.** Adaptive reuse is encouraged in the Urban Use Overlay District. Developments that incorporate an existing structure designated as a significant building in any overlying subarea plan, such as the 2016 West Edge Area Wide Plan, shall receive an exemption from the standards of UDC 6.7. Buildings that receive this exemption shall incorporate design guidelines from the applicable plan.

(c) **Alternatives.** Minor deviations from the standards may be evaluated by the Director to meet the intent of the small scale commercial and mixed-use design standards of the UDC through an alternative design to allow a site-specific plan that is qualitatively equal to or better than the strict application of a design standard specified in this code. This procedure is not intended as a substitute for a variance or administrative adjustment or a vehicle for relief from standards of this Code. To grant an alternative design, the director shall find either:

- (1) The proposed alternative design achieves the intent of the subject design standard to the same or better degree than the subject standard; achieves the goals and policies of PlanCheyenne or the applicable plan to the same or better degree than the subject standard; and results in benefits to the community that are equivalent to or better than compliance with the subject standard; or
- (2) The required improvement would be ineffective because of locational, topographic, or site constraints while the alternative design can accommodate site-specific issues.

3. **Street Trees.** Shall comply with the standards of UDC 6.3.6.

4. **Street Furnishings and Projections into ROW.** May be placed in the ROW so long as the furnishing does not interfere with the 5' required ADA pedestrian zone. All street furnishings and projections into the

ROW shall be shown and approved by the Site Plan process per UDC 2.2.3.b.

- (a) Street furnishings shall include benches, tables, chairs, decorative patio fencing, hosting stands, or other items permitted by the Director.
- (b) Other projections into the ROW may include awnings, patios, or other projections permitted by the Director.

5.7 Specific Use Standards

- 5.7.1 Reserved
- 5.7.2 Home Occupations
- 5.7.3 Accessory Dwelling Units
- 5.7.4 Child Care Uses
- 5.7.5 Assisted Living Facilities
- 5.7.6 Stables, Kennels and Arenas
- 5.7.7 Live / Work Dwellings
- 5.7.8 Automobile Service Stations
- 5.7.9 Bed and Breakfasts
- 5.7.10 Reserved
- 5.7.11 Emergency Shelters
- 5.7.12 Mini Storage

The uses in this section have known or anticipated impacts on adjacent property due to the nature of the operation, scale of the use, or common site and building designs associated with the use. However, these uses may be compatible in various zoning districts if specific standards for the use are followed. Whether these uses are either “permitted”, “administrative”, or “conditional” in any zoning district per Table 5-1, the additional standards in this Section shall apply. If the use is “permitted” in a zoning district these standards shall apply as part of the site plan review; if the use is “administrative” in a zoning district these standards shall apply in association with the Administrative Review criteria in Article 2; if the use is “conditional” in a zoning district these standards shall apply in addition to the discretionary Conditional Review criteria in Article 2.

5.7.1 [Reserved]

5.7.2 Home Occupations

In districts where home occupations are allowed, they shall meet the following standards in addition to all other lot and building standards for the district.

- a. Home occupations include, but are not limited to, arts and crafts-making, tailoring or seamstress services, one or two-person professional offices (medical, insurance, law, etc.), music instruction and wholesale/catalogue sales.
- b. Home occupations are intended to allow limited business activity from the home but shall not alter the character of the neighborhood.
- c. Additional off-street parking may be required for the home occupation business if more than three clients per day are expected to visit the business. No additional parking

spaces shall be provided in the front yard setback (or within the side yard setback if the property is a corner lot). Where needed additional parking would alter the character of the neighborhood the home occupation shall be prohibited.

- d. There shall be no offensive noise, vibration, smoke, dust, odors, heat or glare noticeable at or beyond the property line.
- e. No exterior storage is permitted.
- f. Signage will be limited to one sign not more than three square feet in area per home.
- g. No retail sales are permitted from the site other than incidental sales related to services provided.
- h. Not more than one employee or co-worker other than the permanent resident(s) can work from the site.
- i. An "in-home" business operating from a residential dwelling within shall be registered in the home occupation data base, administered through the City Planning and Development Department.
- j. Specific Exclusions. The following businesses shall not be allowed as home occupations:
 1. Auto body or mechanical repair, to include any modification, assembly or painting of motor vehicles and repair of internal combustion engines;
 2. Massage parlors/technicians;
 3. Beauty parlors, nail salons and barber shops;
 4. Animal grooming salons and boarding kennels;
 5. Body piercing/body art/tattoo art.

5.7.3 Accessory Dwelling Units

In districts where accessory dwelling units are allowed as permitted, administrative or conditional uses, they shall meet the following standards in addition to all other lot and building standards for the district.

- a. The accessory dwelling unit may be in the principal building or any permitted accessory building, however all applicable lot and building type standards for the district shall apply.
- b. Only one accessory dwelling unit is permitted per detached one-unit dwelling lot in any zoning district where accessory dwellings are allowed as permitted, administrative or conditional uses. Accessory dwelling units are prohibited on lots with multi-dwelling buildings, attached dwellings or semi-attached dwellings.
- c. The property owner must occupy either the principal unit or the accessory dwelling unit as their permanent residence.
- d. After approval by the Development Office of an accessory dwelling unit pursuant to subsection (b) of this section, the property owner will record with the Laramie County

real estate office a "Notice of ADU Regulations" that shall contain a legal description of the subject property. The "Notice of ADU Regulations" shall be in a form approved by the Development Office prior to filling.

- e. In no case shall an accessory dwelling unit be more than 40 percent of the principal dwelling unit up to a maximum of 1,200 square feet. This limitation is in addition to all other lot and building standards applicable in the district. Square footage calculations, as contained herein, exclude any related garage, porch, or similar area.
- f. The unit size limitations shall not apply to basement apartments. The size of a basement apartment may occupy the entire floor area of the existing basement.
- g. The accessory dwelling unit shall not include any design elements on principal or accessory buildings that alter the character of the lot, building type or district in general.
- h. An accessory building used for an Accessory Dwelling Unit shall be designed to preserve or complement the architectural design, style and appearance of the principal building.
- i. One off-street parking space shall be provided in addition to that which is required for the principal dwelling, and it shall be located on a discrete portion of the lot.

5.7.4 Child Care Uses

In districts where child care uses are allowed, they shall meet the following standards in addition to all other lot and building standards for the district.

- a. Family Child Care Home (FCCH)
 1. Shall be located within the primary residence of the owner.
 2. No more than 10 children shall be permitted.
 3. All requirements of the Wyoming Department of Family Services shall be met.
- b. Family Child Care Center (FCCC)
 1. Shall be located within the primary residence of the owner.
 2. No more than 15 children shall be permitted.
 3. All requirements of the Wyoming Department of Family Services shall be met.
 4. Parking will be required per Section 6.2.4, Table 6-2.
- c. Child Care Center (CCC)
 1. Shall not be located within a residence.
 2. All requirements of the Wyoming Department of Family Services shall be met.
 3. Parking will be required per Section 6.2.4, Table 6-2.
- d. Child Care provided as an accessory/secondary use to a commercial or industrial business is permitted in any zone

district and must meet all requirements of the Wyoming Department of Family Services.

Table 5-3: Reserved

5.7.5 Assisted Living Facilities, Nursing Homes, and Group Housing

In districts where Assisted Living Facilities, Nursing Homes, or Group Housing are allowed, they shall meet the following standards in addition to all other lot and building standards for the district.

- a. Assisted Living Facilities and Nursing Homes shall be certified by the State of Wyoming. The Wyoming Department of Health, Health Facilities Program, is the duly authorized licensing agency for assisted living facilities pursuant to the state of Wyoming Assisted Living Facilities Rules and Regulations.
- b. Assisted Living Facilities and Nursing Homes located in commercial or mixed-use zones shall provide one signed loading and unloading zone on the same site.
- c. Manufactured housing shall not be utilized for assisted living facilities per state of Wyoming Rules and Regulations.
- d. Group Housing shall be licensed or certified by the appropriate State of Wyoming Department.
- e. Group Housing and Assisted Living Facilities/Nursing Homes must meet fire and building codes adopted by the City of Cheyenne.

5.7.6 Stables, Kennels and Arenas

In districts where stables, kennels and arenas are allowed, they shall meet the following standards in addition to all other lot and building standards for the district.

- a. The site shall be certified by the city-county health unit as not creating a health hazard.
- b. The distance between livestock (in barns, sheds, loafing areas and pastures) and domestic wells shall follow Department of Environmental Quality (DEQ) and city-county health unit requirements.
- c. Adequate on-site parking shall be provided for maximum use of the facility.
- d. Offal/excretion shall be removed on a regular basis so as not to attract flies and create a health hazard.

5.7.7 Live/Work Dwellings

In districts where live/work dwellings are allowed, they shall meet the following standards in addition to all other lot and building standards for this lot and building type established for the NB zoning district.

- a. A live/work building shall have two clearly distinct areas, the living area and the non-living area. These areas may be connected by a doorway but shall have the ability to be separated by a closed and secure door. Each area shall separately and independently meet the required building codes applicable to the intended use for that portion of the building.
- b. The living area of the unit shall represent between 50% and 75% of the total floor area.
 1. The living area shall be at least 700 square feet.
 2. The non-living area shall not exceed 1,500 square feet.
- c. Occupational or vocational uses allowed in the non-living portion may be any non-residential use allowed in the zoning district as either a permitted use or a home occupation.
- d. The facility shall be designed and operated so that no more than 2 non-resident staff shall be at the facility at any one time.
- e. The occupant of both the living area and the non-living area shall be the same individual or group of individuals at all times.
- f. Required parking shall be based on the greater of the parking required for the non-living area or the living area.
- g. The street-front portion of the building shall be designed to match the adjacent street front of buildings on the same side of the block and street front of buildings on the opposite block face.
 1. Where the street front of buildings across the street or adjacent to the unit are retail or service uses, the street front portion of the unit shall be the non-living area and subject to the Small-scale Commercial and Mixed-use Design Standards in Section 6.7.
 2. Where the street front of buildings across the street or adjacent to the unit are residential, the street-front portion of the unit shall be the living area and subject to the Residential Design Standards in Section 6.6.
 3. Where the street front of buildings across the street and adjacent to the unit are a mix or residential and service or retail uses, the unit shall be designed to be compatible to the most prevailing pattern on the block. In determining the most prevailing pattern, immediately adjacent buildings shall be considered more heavily.

5.7.8 Automobile Service Stations

In districts where automobile service stations are allowed, they shall meet the following standards in addition to all other lot and building standards for the district.

- a. **Building Designs.** In districts that require a specific building frontage, build-to-line or other building design standards, Automobile service stations are granted exceptions to those standards provided the following alternative standards are met:
 - 1. All buildings shall have at least one street-facing façade that includes a primary building entrance.
 - 2. At least 60% of any building facade within 30' of the right-of-way shall be openings including windows and doors.
 - 3. Any building that is not constructed according to the required build-to-line shall have an alternative streetscape edge shall occur along at least 60% of all right-of-way frontage. The defined edge may include any combination of the following:
 - (a) Any portion of the building façade built according to the required build-to-line, meets the general building design standards for the district;
 - (b) A 2.5 foot to 4 foot high decorative masonry wall or ornamental fence, matching the materials and architecture of the building;
 - (c) A 2.5 foot to 4 foot dense vegetative screen;
 - (d) On corner lots, the first 20' in each direction from the corner of the lot shall have a defined streetscape edge, subject to any site distance requirements at the intersection.
- b. **Landscape and Screening Enhancements.** In addition to other provisions of Section 6.3, any Automobile Service station within 200' of a residentially zoned lot shall have a 10% area increase and a 10% plant material increase, allocated to buffering the site from residential uses. An exception to this requirement may be granted by Administrative Adjustment according to the procedures and criteria in Article 2, provided an alternative transition suitable to the context of the neighborhood and site is designed.

5.7.9 Bed and Breakfasts

In any residential zoning districts where Bed and Breakfasts are allowed, they shall meet the following standards in addition to all other lot and building standards for the district:

- a. Bed and breakfasts shall be accessory to a principal dwelling unit.
- b. In the all districts except the AG, AR, and RR zoning districts, bed and breakfasts should be located only on lots within 660 feet of an Activity Center or similar neighborhood commercial or mixed-use environment, measured along a dedicated pedestrian route.
- c. Bed and breakfasts shall contain no more than 6 guest rooms.
- d. The owner of the business shall maintain a permanent residence in either the principle dwelling unit or accessory dwelling unit.
- e. Guests must pay on the basis of a daily rental rate, and must limit their stay to 14 consecutive days.
- f. Guests rooms are to be limited to the purpose of sleeping and kitchen or cooking facilities shall not be allowed in guest rooms.
- g. Receptions or meetings of groups are prohibited.
- h. The facility shall require no more than 2 non-resident staff to be at the facility at any one time.
- i. One off-street parking space shall be provided per 2 guest rooms in addition to that which is required for the principal dwelling, and they shall be located on a discrete portion of the lot.
- j. The bed and breakfast shall not include any design elements on principal or accessory buildings that alter the character of the lot, building type or district in general.

5.7.10 [RESERVED]

5.7.11 Emergency Shelter

In districts where emergency shelters are allowed, they shall meet the following standards in addition to all other lot and building standards for the district.

- a. An Emergency Shelter shall not be located within five hundred (500) feet of any LR (Low-Density Residential), MR (Medium Density Residential), HR (Highdensity Residential), NR-1 (Neighborhood Residential - Moderate Density), NR-2 (Neighborhood Residential - Medium Density), NR-3 (Neighborhood Residential - High Density), and MUR (Mixed-Use Residential Emphasis) zoned property.

Measurement shall be made in a straight line, without regard to intervening structures or streets, from the nearest portion of the building, structure, or site associated with the use to the nearest property line.

5.7.12 Mini Storage

In districts where Mini Storage is permissible by conditional discretionary review the following additional standards shall apply:

- a. In MR, HR, MUR, and MUB Districts:
 - 1. The minimum lot area shall be one (1) acre.
 - 2. The use shall be adjacent to a right-of -way with a functional classification of a Major Collector, Minor Arterial, or Principal Arterial.
 - 3. A Level 1 buffer shall apply to all property lines in accordance with UDC 6.3.5.b.
 - 4. Parking areas for the storage of vehicles, trailers, recreational vehicles, boats, snow mobiles and other similar items shall not exceed twenty-five (25) percent or one half (1/2) acre of the lot area, whichever is more restrictive. A solid fence, wall, or similar design element is required to screen any portion of the lot dedicated for this purpose from neighboring residential properties.
- b. In the CBD District:
 - 1. No parking area for the storage of vehicles, trailers, recreational vehicles, boats, snow mobiles and other similar items shall be permitted.
 - 2. All storage units shall be internally accessed within a building. No unit shall have direct access to the exterior of the building.
 - 3. Parking and loading areas shall be located behind the principal building and shall not be visible from adjacent street rights-of-way.
 - 4. Structures shall be setback no more than ten (10) feet from any property line adjacent to a street right-of-way.
 - 5. All developments shall meet the Small Scale Commercial and Mixed-use Design Standards of UDC Chapter 6. 7.

5.8 Supplemental Provisions

- 5.8.1 Wireless Telecommunication Services
- 5.8.2 Manufactured Homes and Parks
- 5.8.3 Drive-through facilities
- 5.8.4 Fences
- 5.8.5 Refuse Containers
- 5.8.6 Outdoor Storage
- 5.8.7 Oil and Gas Support Service
- 5.8.8 Accessory Buildings

The standards in this section have broad application across a number of zoning districts, and to a number of uses or site conditions within zoning districts. The standards in this section are supplemental to all other standards, and apply in addition to any other standards applicable within the zoning district.

5.8.1 Wireless Communication Facilities

a. Purpose.

1. The purpose of this Section is to establish general guidelines for siting traditional wireless communications towers and newer small wireless facilities within zone districts and rights-of-way. The goals of this Section are to: (1) protect residential areas and land uses from potential impacts of towers; (2) encourage the location of towers where they will best serve citizens and first responders; (3) strongly encourage the joint use of new and existing tower sites as a primary option rather than construction of additional single-use towers; (4) encourage users of towers to locate them, to the extent possible, in areas where the impact on the community is minimal; and (5) facilitate the deployment of small wireless facilities in the rights-of-way.
2. It is not the intent or purpose of this Section to prohibit or have the effect of prohibiting the deployment of wireless communications facilities, to regulate the placement, installation, or modification of such facilities on the basis of radio frequency emissions, or to unreasonably discriminate among wireless communications providers who provide functionally equivalent services. Nothing contained in this Section is intended or has the purpose to preempt any State or federal law applicable to wireless communications facilities.

b. Definitions.

As used in this Section, the following terms shall have the meanings set forth below:

Antenna. Any transmitting or receiving communication device that sends or receives electromagnetic waves, digital signals, analog signals, radio frequencies (excluding radar signals), wireless telecommunications signals or other communication signals.

Antenna array. A single or group of antenna elements, not including small wireless facility antennas, and associated mounting hardware, transmission lines, remote radio units, or other appurtenances which share a common attachment device such as a mounting frame or mounting support structure for the sole purpose of transmitting or receiving wireless communication signals.

Applicant. Any person engaged in the business of providing wireless communication services or the wireless communications infrastructure required for wireless communication services and who submits an application.

Backhaul network. The physical telephone or fiber optic lines or microwave dishes that connect a provider's towers or cell sites to other cell sites or one or more cellular telephone switching offices or long-distance providers, or the public switched telephone network.

Base station. A structure or equipment at a fixed location that enables FCC-licensed or authorized wireless communications between user equipment and a communications network. The definition of Base Station does not include or encompass a tower, or any accessory equipment associated with a tower. A base station includes, without limitation:

- A. Equipment used or contemplated to be used to support wireless communications services such as private, broadcast, and public safety services, as well as unlicensed wireless services and fixed wireless services such as microwave backhaul that, at the time the relevant application is filed with the City under this Section, has been reviewed and approved under the applicable zoning or siting process, or under another state or local regulatory review process, even if the structure was not built for the sole or primary purpose of providing such support; and
- B. Radio transceivers, antennas, coaxial or fiber-optic cable, regular and backup power supplies, and

comparable equipment, regardless of technological configuration (including Distributed Antenna Systems (“DAS”) and small wireless facilities).

Collocation. The mounting or installation of equipment on an existing tower, building, or structure for the purpose of transmitting or receiving radio frequency signals for communications purposes.

Distributed Antenna System or DAS. A network consisting of transceiver equipment at a central hub site to support multiple antenna locations throughout the desired coverage area.

Eligible Facilities Request. Any request for modification of an existing tower or base station that does not substantially change the physical dimensions involving:

- A. collocation of new equipment,
- B. removal of equipment, or
- C. replacement of equipment.

Eligible support structure. Any tower or base station as defined in this Section, provided that it is existing at the time the relevant application is filed with the City under this Section.

Existing. A tower or base station that has been reviewed and approved under the applicable zoning or siting process, or under another State or local regulatory review process, provided that a tower that has not been reviewed and approved because it was not in a zoned area when it was built, but was lawfully constructed, is existing for purposes of this definition.

FAA. The Federal Aviation Administration.

FCC. The Federal Communications Commission.

Macro cell. An antenna or antennas mounted on or in a tower, ground-based mast, rooftops or structures, at a height that provides coverage to the surrounding area.

Micro wireless facility. A small wireless facility that is less than 24 inches in length, 15 inches in width, and 12 inches in height and that has an exterior antenna less than 11 inches in length.

Pole. A pole or similar structure that is or may be used in whole or in part by or for wireline communications, electric distribution, lighting, signage, or a similar function, or for the collocation of small wireless facilities.

Replacement pole. Replacing an existing pole, with a pole of similar height, design and color to accommodate the collocation of a small wireless facility.

Site. In relation to a tower that is not in the public right-of-way, the current boundaries of the leased or owned property surrounding the tower and any access or utility easements currently related to the site. In relation to support structures other than towers, site means an area in proximity to the structure and to other transmission equipment already deployed on the ground.

Small wireless facility(ies). Facilities that meet the following conditions: (1) the facilities -- (i) are mounted on structures fifty (50) feet or less in height including their antennas, or (ii) are mounted on structures no more than ten percent (10%) taller than other adjacent structures, or (iii) do not extend existing structures on which they are located to a height of more than fifty (50) feet or by more than ten percent (10%), whichever is greater; (2) each antenna associated with the deployment, excluding associated antenna equipment, is no more than three (3) cubic feet in volume; (3) all other wireless equipment associated with the structure, including the wireless equipment associated with the antenna and any pre-existing associated equipment on the structure, is no more than twenty eight (28) cubic feet in volume; (4) the facilities do not require antenna structure registration under federal law; (5) the facilities are not located on Tribal land as defined under federal law; and (6) the facilities do not result in human exposure to radiofrequency radiation in excess of the applicable safety standards specified under federal law. The following types of associated ancillary equipment are not included in the calculation of equipment volume: electric meter, concealment elements, telecommunications demarcation box, grounding equipment, power transfer switch, cut-off switch, and vertical cable runs for the connection of power and other services.

Stealth design. A design that minimizes the visual impact of wireless communication facilities by camouflaging, disguising, screening or blending them into the surrounding environment. Examples of stealth design include but are not limited to facilities disguised as trees (monopines), flagpoles, utility and light poles, bell towers, clock towers, ball field lights and architecturally screened roof-mounted antennas or flush-mounted antennas that are either painted to match or enclosed in an architecturally-applicable box.

Substantial change. A significant change as defined in the Code of Federal Regulations (Title 47 Part 1 Subpart U § 1.6100(b)(7)).

Support structure(s). A structure designed to support small wireless facilities including, but not limited to billboards and other freestanding self-supporting structures.

Tower. Any structure built for the sole or primary purpose of supporting any FCC-licensed or authorized antennas and their associated facilities, including structures that are constructed for wireless communication services including, but not limited to, private, broadcast, and public safety services, as well as unlicensed wireless services and fixed wireless services such as microwave backhaul and the associated site.

Tower height. The vertical distance measured from the base of the tower structure at grade to the highest point of the structure including the antenna. A lightning rod, not to exceed ten (10) feet in height, shall not be included within tower height.

Traffic control devices. Traffic control devices shall be defined as all signs, signals, markings, and other devices used to regulate, warn, or guide traffic, placed on, over, or adjacent to a street, highway, pedestrian facility, bikeway, or private road open to public travel by authority of a public agency or official having jurisdiction, or, in the case of a private road, by authority of the private owner or private official having jurisdiction, as defined in the latest edition of the Manual On Uniform Traffic Control Devices (MUTCD).

Transmission equipment. Equipment that facilitates transmission for any FCC-licensed or authorized wireless communication service, including, but not limited to, radio transceivers, antennas, microwave dishes, coaxial or fiber-optic cable, and regular and backup power supplies. The term includes equipment associated with wireless communication services including, but not limited to, private, broadcast, and public safety services, as well as unlicensed wireless services and fixed wireless services such as microwave backhaul.

Wireless communication facilities or WCF. An unstaffed facility or equipment for the transmission or reception of radio frequency (RF) signals, wireless communications, or other signals for commercial communications purposes, typically consisting of a group of antennas, a tower or base station, transmission cables and other transmission equipment, backup power supplies, power transfer

switches, cut-off switches, electric meters, coaxial cables, fiber optic cables, wires, telecommunications demarcation boxes and related materials and equipment cabinets, and including small wireless facilities.

c. Applicability.

1. *New Towers, Antennas, DAS, and Small Wireless Facilities.* All new towers, antennas, DAS, and small wireless facilities shall be subject to these regulations.
 - (a) New towers exceeding the maximum height limitation in LR, MR, HR, N1, and N3 zone districts and towers exceeding 50' in non-residential districts, including those for small wireless facilities, require conditional use approvals.
 - (b) New antenna arrays meeting the requirements of Section 5.8.1.f.17 below are permitted with a building permit.
 - (c) Small wireless facilities are permitted in any zone pursuant to Section 5.8.1.e.
 - (d) Antennas attached to utility poles, light poles, traffic control devices, or similar items in the public rights-of-way are subject to approval by the City Engineer in accordance with UDC 1.2.2.b. 10' above the highest point of the pole structure and may be installed when permitted by the pole owner's franchise or by amendment to the pole owner's franchise and consent of the City upon payment of reasonable compensation for use of the rights-of-way.
2. *Exempt Facilities.* The following are exempt from this Section:
 - (a) FCC licensed amateur (ham) radio facilities;
 - (b) Satellite earth stations, dishes, or antennas used for private television reception not exceeding one (1) meter or 3.28 feet in diameter;
 - (c) A WCF installed upon the declaration of a state of emergency by the federal, state or local government, or a written determination of public necessity by the City; except that such facility must comply with all federal and State requirements. The WCF shall be exempt from the provisions of this Section for up to one month after the duration of the state of emergency;
 - (d) A temporary, commercial WCF installed for providing coverage of a special event such as news coverage or sporting event, subject to approval by the City. The WCF shall be exempt from the provisions of this Section for up to two weeks before and one week after the duration of the special event;

- (e) Other temporary, commercial WCFs installed for a period of up to thirty (30) days, subject to the City's discretion; provided that such temporary WCF will comply with applicable setbacks and height requirements;
 - (f) Antennas attached to existing structures (such as commercial buildings, houses or apartments) for Internet purposes and used solely by occupants of the building to which the antennas are attached as long as the height limitations of the zoning district are not exceeded, and the antenna design is satisfactory to the City; and
 - (g) Routine maintenance and repair of WCFs.
- d. **Use Categories.**
1. *Use by Right.*
 - (a) *General.* The uses listed in this Section are uses by right in any zone, but a site plan and any necessary legal instruments including, but not limited to, a lease agreement, are required.
 - (b) *County or City Property.* The following use is specifically permitted:
 - (1) Antennas located on Laramie County property within the City or on City property (excluding public rights-of-way), provided a lease authorizing the facility has been approved by the County or the City respectively.
 2. *Administrative and Conditional Use Approval.*
 - (a) *General.* In addition to the review procedures and approval criteria of Sections 2.2.5 (Conditional Use Approval), 2.2.6 (Administrative Use Approval), and the General Requirements of Section 5.8.1.f, the following provisions shall govern the issuance of administrative approvals.
 - (1) Each applicant for administrative approval shall provide the information set forth in this Section. A fee is required and shall be set by the City.
 - (2) Administrative Review Process (Administrative Review). The Director shall review the application and determine if the proposed use complies with this Section. For applications involving proposed uses within a public right-of-way, the Director shall obtain the approval of the City Engineer prior to approval of the application.
 - (3) In connection with any such Administrative Review, the City may, in order to encourage shared use, administratively waive any zoning district setback requirements or separation distances, if any, between towers by up to fifty (50) percent. Setback requirements shall not apply within or adjacent to a right-of-way.
- (4) In connection with any Administrative Review and approval, the City may, in order to encourage the use of monopoles, administratively allow the on-site upgrade or reconstruction of an existing tower to monopole construction.
 - (5) No new macro cell tower application shall be processed unless the applicant has discussed the proposal with the Director prior to submission to review the feasibility of using an existing tower or structure. The applicant must demonstrate that there is no current facility that can reasonably accommodate the applicant's proposed antenna.
- (b) *List of Administratively Approved Uses.* The following uses may be approved (for uses which do not qualify as a use by right or require Board Approval) by Administrative Review:
- (1) Locating a tower, including the placement of additional buildings or other supporting equipment used in connection with said tower in the heavy industrial district, provided the tower height does not exceed one hundred (100) feet;
 - (2) Locating antennas on existing structures or towers consistent with the terms of subsections i. and ii. below:
 - i. Antennas on Buildings. Any antenna which is not attached to a tower may be approved by the development office as an accessory use to any commercial, industrial, professional, institutional, or multifamily structure of eight or more dwelling units, provided the antenna does not extend more than ten (10) feet above the highest point of the structure.
 - ii. Antennas on Existing Towers or Reconstruction of an Existing Tower. An antenna which is attached to an existing tower may be approved by the development office. Reconstruction of a tower which provides for future collocation of antennas shall take precedence over the construction of new towers, provided such collocation

or reconstruction is accomplished in a manner consistent with the following:

(A) A tower which is modified or reconstructed to accommodate the collocation, unless determined through Administrative Review reconstruction as a monopole is allowed.

(B) Height:

- (1) An existing tower may be modified or rebuilt to a taller height, not to exceed forty (40) feet over the tower's existing height, to accommodate the collocation of additional antennas.
- (2) The height change referred to in this Section may only occur one time per tower.
- (3) The additional height referred to in this Section shall not require additional setback distance separation. The tower's prior height shall be used to calculate such distance separations.

(C) On-site location:

- (1) A tower which is being rebuilt to accommodate the collocation of an additional antenna may be moved on-site within fifty (50) feet of its existing location.
- (2) After the new tower is built to accommodate collocation, only one tower may remain on the site, and the original tower shall be removed within ninety (90) days of completion of the new tower.
- (3) The on-site relocation of a tower which does not comply with the separation distances to residential units or residentially zoned lands shall only be permitted when approved by the Board.

(3) *New Towers in Nonresidential Zoning Districts.* Locating any new tower in a nonresidential zoning district, provided a Wyoming licensed professional engineer certifies the tower can structurally accommodate the number of shared users proposed by the applicant and the tower meets the height and usage criteria of the respective zone.

(4) Locating any alternative tower in a zoning district that, in the judgment of the Director, is in conformity with this Section.

(5) Installing a micro wireless facility through the use of low-powered transmitters/receivers attached to existing wireline systems, such as conventional cable or telephone strand.

(6) Modification of an existing tower or base station pursuant to an Eligible Facilities Request and in accordance with the standards set forth in this Section.

(7) Installing small wireless facilities, poles and replacement poles.

(c) *List of Conditional Use Approvals.* New macro cell towers located in the following residential zone districts: LR, MR, HR, NR-1, NR-2, and NR-3 shall require Board approval in compliance with Sections 2.2.4 (Conditional Use Approval) and 5.8.1.g.3 (*Factors Considered in Granting Conditional Use Approvals for Towers*).

e. ***Distributed Antenna Systems and Small Wireless Facilities.***

1. Distributed antenna systems and small wireless facilities are permitted uses subject to Administrative Review and the following standards:

(a) Facilities shall be a permitted use subject to administrative approval in all zoning districts and public rights-of-way as long as the pole or tower does not exceed the maximum height limit of the affected zoning district.

(b) Monopoles and replacement poles shall be a permitted use subject to administrative approval in utility and public rights-of-way, up to the greater of forty (40) feet or ten (10) percent higher than any pole in the rights-of-way which is within five hundred (500) feet.

(c) Facilities may be located on a support structure, replacement pole, or other pole located in public or utility rights-of-way.

- (d) Facilities shall not extend eight (8) feet above buildings, existing structures, or other similar structures. Facilities shall not extend more than ten (10) feet above poles or support structures.
 - (e) The height of any free-standing facility shall not exceed the greater of forty (40) feet or ten (10) percent higher than poles in the rights-of-way which are within five hundred (500) feet.
 - (f) Facilities that use the structure of a utility pole for support are permitted under this Section. Such poles may extend up to ten (10) feet above the height of the utility pole.
 - (g) Facilities and monopoles and replacement poles in the right-of-way shall be exempt from all setback requirements.
 - (h) Facilities shall comply with all applicable codes.
 - (i) Facilities and equipment shall, to the extent possible, use materials, colors, textures, screening, undergrounding, or other design options that will blend the facility into the surrounding natural setting or built environment. Design, materials, and colors of facilities shall be compatible with the surrounding environment. Designs shall be compatible with structures and vegetation located in the public right-of-way and on adjacent parcels. These aesthetic requirements are reasonable, objective, non-discriminatory and published per this ordinance.
2. *Application Requirements.* An application for a facility as a permitted use subject to Administrative Review shall contain the following:
- (a) The signature of the authorized agent of the property owner, or the owner of the existing structure, support structure, pole or replacement pole.
 - (b) Separate pole attachment agreements with the pole owner, if the applicant seeks to install an attachment on another party's pole.
 - (c) A map showing the intended location(s) of the facility(ies), representative pictures of the intended facilities, and stamped engineering and construction plans and drawings.
 - (d) A statement certifying compliance with all non-discretionary structural, electrical, energy, building, safety and other applicable codes.
3. *Permitted Uses.* Facilities are permitted uses in all zones, regardless of siting preferences identified herein, provided the applicant complies with all federal laws (such as the Americans with Disabilities Act), State laws and requirements, and stealth requirements of this Section.
4. *Batched Applications.* A single administrative approval application may be used for multiple distributed antennas that are part of a larger overall DAS network. A single administrative approval application may also be used for multiple sites for small wireless facilities. A single license agreement may be used for multiple node locations in DAS and/or small wireless facility networks.
- f. **General Requirements.**
- 1. *Principal or Accessory Use.* DAS and small wireless facilities may be considered either principal or accessory uses. A different existing use of an existing structure on the same lot shall not preclude the installation of an antenna or tower on such lot.
 - 2. *Lot Size.* The dimensions of the entire lot shall control for purposes of measurements, even though the antennas or towers may be located on leased parcels within a lot.
 - 3. *Lighting.* Towers may not be artificially lighted, unless required by public safety, the FAA or other applicable authority.
 - 4. *State or Federal Requirements.* All towers and antennas must meet current standards and regulations of the FAA, FCC and any other agency of the local, state or federal government with the authority to regulate towers and antennas.
 - 5. *Building Codes; Industry Standards.* To ensure the structural integrity of towers, the owner of a tower shall ensure that the tower is maintained in compliance with applicable state and local building code standards and the then applicable Industry standards for towers.
 - 6. *Permit or License.* Owners and operators of towers and antennas shall certify that any permit or license required for the construction and operation of a wireless communication system in the City has been obtained.
 - 7. *Public Notice.* For purposes of this Section, any application for a WCF, including small wireless facilities, variance, exception, or appeal of a request for approval requires public notice to all adjoining property owners and all owners of surrounding properties as required by the Unified Development Code.
 - 8. *Multiple Antennas/Towers.* Users are encouraged to submit a single application for approval of multiple towers and/or antenna sites. An application for multiple sites will be given priority in the review process.

9. *Equipment Cabinets.*
- (a) Compliance. The equipment cabinets shall comply with all applicable building codes and zoning requirements. The site plan submitted with an application for administrative approval shall include the equipment cabinet, if any.
 - (b) Location. The equipment cabinet or structure used in association with antennas shall be located in accordance with the site plan to be approved by Administrative Review.
 - (c) Minimum Requirements. The related equipment structure shall be located in accordance with the minimum requirements of the zoning district in which it is located. A site plan application, any other applicable applications, and associated fees are required.
10. *Inventory of Existing Sites.* Not more than one time every five (5) years, each applicant for a macro cell shall provide to the Director and City Engineer an inventory of the wireless carrier's existing towers, antennas, or sites approved for towers or antennas, that are either within the jurisdiction of the City or within one mile of the border thereof, including specific information about the location and height. The Director and City Engineer may share such information with other applicants applying for approvals under this Section or other organizations seeking to locate antennas within the jurisdiction of the City, provided, however, that the Director and City Engineer are not, by sharing such information, in any way representing or warranting that such sites are available or suitable.
11. *Color.* To the extent feasible, the antenna array shall be placed and colored to blend into the architectural detail and coloring of the host structure. Towers shall be painted a color that best allows it to blend into the surroundings. The use of grays, blues, greens, dark bronze, browns or other site-specific colors may be appropriate; however, each case should be evaluated individually.
12. *Site Development Standards.* All wireless communication facilities shall be required to obtain required approvals and shall be subject to the site development standards prescribed herein. A site development plan, at minimum, shall contain the following information:
- (a) Construction drawings, stamped by a professional engineer, showing the proposed method of installation;
 - (b) The manufacturer's recommended installations, if any;
 - (c) A diagram to scale showing the location of the wireless communication facility, property and setback lines, easements, power lines, all structures, and the required landscaping; and
 - (d) Photo simulations that include to-scale visual simulations that show unobstructed before-and-after construction daytime and clear-weather views from at least four angles, together with a map that shows the location of each view, including all equipment and cabling.
13. *Signs.* No facilities may bear any signage other than that required by law or expressly permitted or required by the City, except if such signage functions in a manner designed to conceal the facility and is aesthetically consistent with its context.
14. *Visual Impact.* All WCFs in residential districts and within two hundred feet (200') of residential districts or the Greenway shall be sited and designed to minimize adverse visual impacts on surrounding properties and the traveling public to the greatest extent reasonably possible, consistent with the proper functioning of the WCF. Such WCFs and equipment enclosures shall be integrated through location and design to blend in with the existing characteristics of the site. Such WCFs shall also be designed to either resemble the surrounding landscape and other natural features where located in proximity to natural surroundings, or be compatible with the built environment, through matching and complementary existing structures and specific design considerations such as architectural designs, height, scale, color and texture or be consistent with other uses and improvements permitted in the relevant zone.
15. *Use of Stealth Design.* The applicant shall use stealth design to the maximum extent feasible unless otherwise approved by the City. Stealth and concealment techniques must be appropriate given the proposed location, design, visual environment, and nearby uses, structures, and natural features. Stealth design shall be designed and constructed to substantially conform to surrounding building designs or natural settings, so as to be visually unobtrusive. Stealth design that relies on screening wireless communication facilities in order to reduce visual impact must screen all substantial portions of the facility from view.

16. *Building-mounted WCFs.*
- (a) All transmission equipment shall be concealed within existing architectural features to the maximum extent feasible. Any new architectural features proposed to conceal the transmission equipment shall be designed to mimic the existing underlying structure, shall be as proportional as possible to the existing underlying structure or conform to the underlying use and shall use materials in similar quality, finish, color and texture as the existing underlying structure.
 - (b) All roof-mounted transmission equipment shall be set back from all roof edges to the maximum extent feasible consistent with the need for "line-of-sight" transmission and reception of signals.
 - (c) Antenna arrays and supporting transmission equipment shall be installed so as to camouflage, disguise or conceal them to make them closely compatible with and blend into the setting or host structure.
17. *Antenna Arrays.* Wireless communication antenna arrays are permitted, subject to review and approval, in any zone as long as they are located upon an existing structure on private property (except on single family houses, duplexes, or signage, but shall be allowed on industry standard billboards or large signs exceeding 600 sq. ft., in size), that provides sufficient elevation for the array's operation without the necessity of constructing a tower or other apparatus to extend the antenna array more than ten feet (10') above the structure. Installation on City property requires the execution of necessary agreements. However, if any tower exceeding the height limitation of the zoning district is needed to achieve the desired elevation, then a conditional use approval is required.
18. *Pole-Mounted Equipment.* All pole-mounted transmission equipment shall be mounted as close as technically possible to the pole so as to reduce the overall visual profile to the maximum extent feasible subject to applicable safety codes.
19. *Permit, License or Agreement.* For all WCFs to be located within the rights-of-way, prior to applying for an administrative approval, the applicant must have a valid permit, municipal agreement, license, Right-of-Way agreement, encroachment permit, or exemption otherwise granted by applicable law. Prior to the installation or construction of a WCF within the rights-of-way or a utility easement, the applicant or provider must notify all utilities located within such rights-of-way or utility easement regarding the use of the rights-of-way or utility easement.
20. *Accessory Equipment.* In residential districts, within 200 feet of a residential district or the Greenway, all accessory equipment located at the base of a WCF shall be located or placed (at the applicant's choice) in an existing building, underground, or in an equipment shelter or cabinet that is (a) designed to blend in with existing surroundings, using architecturally compatible construction and colors; and (b) be located so as to be as unobtrusive as possible consistent with the proper functioning of the WCF.
21. *Site Design Flexibility.* Individual WCF sites vary in the location of adjacent buildings, existing trees, topography and other local variables. By mandating certain design standards, there may result a project that could have been less intrusive if the location of the various elements of the project could have been placed in more appropriate locations within a given site. Therefore, the WCF and supporting equipment shall be installed so as to best camouflage, disguise or conceal them, to make the WCF more closely compatible with and blend into the setting or host structure, upon approval by the City.
22. *Landscaping, Screening, Fencing, and Walls.*
- (a) Equipment shelters and cabinets and other on the ground ancillary equipment (except for those in the public rights-of-way) shall be screened from view from adjacent rights-of-way, residential properties, commercial properties, the Greenway, parks and open space by landscaping, a site-obscuring fence or wall. Alternatively, where technically feasible, the applicant shall incorporate the cabinet and other equipment into the base of a new pole (for example, for a small wireless facility) provided there is adequate space in the right-of-way and that ADA sidewalk accessibility requirements can be met. All provisions of the ADA (including, but not limited to, clear space requirements) shall be met by the applicant.
 - (b) In particular, the ground level view of towers outside of the public-rights-of-way shall be mitigated by additional landscaping provisions as established through the administrative approval process.
 - (c) Except for locations in the rights-of-way, a site-obscuring fence or wall shall be constructed around each tower and around related support

or guy anchors at the height specified for the particular zoning district. Access shall only be through a locked gate. Fences and walls shall comply with applicable design standards of the Unified Development Code.

- (d) *New Poles.* To the extent technically feasible, new poles must be designed to match the existing light fixtures and other poles, and they shall serve a dual purpose (for example, a new light fixture, flag pole or banner clips).
23. *Additional Submittal Requirements for Towers.* At the time of filing an approval application for a tower, an applicant shall provide all of the following:
- (a) *Collocation Consent.* A written statement will be signed by a person with the legal authority to bind the applicant and the project owner, which indicates whether the applicant is willing to allow other transmission equipment owned by others to collocate with the proposed wireless communication facility whenever technically and economically feasible and aesthetically desirable.
- (b) *Design Justification.* A clear and complete written analysis that explains how the proposed design complies with the applicable design standards under this Section to the maximum extent feasible. A complete design justification must identify all applicable design standards under this Section and provide reasons why the proposed design either complies or cannot feasibly comply.
- (c) *Noise Study.* A noise study shall be required if the anticipated noise generated by the facility is expected to be at least 72 dBA or above the ambient (existing background) noise level, and the proposed site is in or within two hundred feet (200') of a residential district or the Greenway, for the proposed WCF and all associated equipment. The WCF shall not interfere with the peaceful and quiet enjoyment of the surrounding area and shall not create a nuisance to pedestrian or vehicular traffic.
- (d) *Additional Information Required.* Applicants for a conditional use approval for a tower shall also submit the following information:
- (1) A scaled site plan clearly indicating the location, type, height and width of the proposed tower, on-site land uses and zoning, adjacent land uses and zoning (including when adjacent to other municipalities or the County), separation distances, adjacent roadways, photo simulations, a depiction of all proposed transmission equipment, proposed means of access, setbacks from property lines, elevation drawings or renderings of the proposed tower and any other structures, topography, parking, utility runs and other information deemed by the City to be necessary to assess compliance with this Section.
- (2) Legal description of the parent tract and leased parcel (if applicable).
- (3) The setback distance between the proposed tower and the nearest residential unit and the nearest residentially zoned property.
- (4) A landscape plan showing specific landscape materials, if applicable.
- (5) Method of fencing, and finished color and, if applicable, the method of camouflage and illumination.
- (6) A certification of compliance with all applicable federal, state and local laws.
- (7) A description of the suitability of the use of existing towers or other structures to provide the services to be provided through the use of the proposed new tower.
- (8) A clear and complete written statement of purpose which shall minimally include: (1) a description of the objective to be achieved; (2) a to-scale map that identifies the proposed site location and the targeted service area to be benefited by the proposed project; and (3) full-color signal propagation maps with objective units of signal strength measurement that show the applicant's current service coverage levels from all adjacent sites without the proposed site, predicted service coverage levels from all adjacent sites with the proposed site, and predicted service coverage levels from the proposed site without all adjacent sites. These materials shall be reviewed and signed by a Wyoming-licensed professional engineer or a qualified employee of the applicant. The qualified employee of the applicant shall submit his or her qualifications with the application.

24. *Radio Frequency (RF) Emissions Compliance Report.* A written report will be prepared, signed, and sealed by a Wyoming-licensed professional engineer or a qualified employee of the applicant, which assesses whether the proposed WCF demonstrates compliance with the RF emissions limits established by the FCC. The qualified employee of the applicant shall submit his or her qualifications with the application.
25. *Noise.* In residential zone districts, or within two hundred feet (200') of a residential district or the Greenway, noise levels shall not exceed 55 dBA during daytime hours (7 a.m. to 10:30 p.m.) and 50 dBA during nighttime hours (10:30 p.m. to 7 a.m.) at a point measured horizontally from the tower, related appurtenances and related equipment cabinets. However, emergency backup power equipment may operate up to 72 dBA for up to 72 hours.
- g. **Sharing of Towers and Collocation of Facilities.**
1. It is the policy of the City to minimize the number of wireless communication towers and to encourage the collocation of antenna arrays of more than one wireless communication service provider on a single tower.
 2. For macro cell towers seventy-five (75) feet and taller, no new macro cell tower may be constructed within one thousand (1,000) feet of an existing macro cell tower, unless it can be demonstrated an existing macro cell tower is not available or feasible for collocation of an additional wireless communication facility, or that its specific location does not satisfy the operational requirements of the applicant. For macro cell towers less than seventy-five (75) feet tall, no new macro cell tower may be constructed within five hundred (500) feet of an existing macro cell tower, unless it can be demonstrated an existing macro cell is not available or feasible for collocation of an additional wireless communication facility, or that its specific location does not satisfy the operational requirements of the applicant. Factors to be considered in determining whether an applicant has made this demonstration include those listed in the subsection 3. below.
 3. *Factors Considered in Granting Conditional Use Approvals for Towers.* In addition to any standards pursuant to the Unified Development Code, the Board shall consider the following factors in determining whether to recommend a conditional use approval, although the Board may waive or reduce the burden on the applicant of one or more of these criteria if the Board concludes that the goals of this Section are better served thereby.
 - (a) Towers exceeding a height of fifty (50) feet shall be able to accommodate collocation of one additional provider. Additional height to accommodate additional collocation may be approved if the applicant submits information certifying the tower has capacity for at least two (2) additional providers. The applicant shall provide a letter indicating its good faith intent to encourage collocation on the tower.
 - (b) Proximity of the tower to residential structures, residential districts, the Greenway and downtown area.
 - (c) Nature of uses on adjacent and nearby properties.
 - (d) Surrounding topography.
 - (e) Surrounding tree coverage and foliage.
 - (f) Design of the tower, with particular reference to design characteristics that have the effect of reducing or eliminating visual obtrusiveness.
 - (g) Proposed ingress and egress.
 - (h) No existing structures are located within the geographic area which meet applicant's engineering requirements.
 - (i) Existing towers or structures do not have sufficient structural strength to support applicant's proposed antenna and related equipment.
 - (j) The fees, costs, or contractual provisions required by the owner in order to share an existing tower or structure or to adapt an existing tower or structure for sharing are unreasonable. Costs exceeding new tower development are presumed to be unreasonable.
 - (k) The applicant demonstrates that there are other limiting factors not enumerated herein that render existing towers and structures unsuitable.
 - (l) Compliance with the requirements of Section 5.8.1.f (General Requirements).
 4. *Placement Provisions.* Macro cell towers that are proposed to be located in a residential district or within 200 feet of a residential district or the Greenway shall be subject to the siting priorities set forth for preferred tower locations in this Section.
- h. **Setback Requirements.**
1. The tower structure shall be set back from property lines as required by that zone, master plan, if any, or a minimum of one foot (1') for every foot of tower height, whichever produces the greater setback, unless:
 - (a) The setback is waived by the owner of the

adjacent property and that waiver is accepted in conjunction with Administrative Review; or

- (b) The tower is constructed with breakpoint design technology. If the tower has been constructed using breakpoint design technology, the minimum setback distance shall be equal to one hundred ten percent (110%) of the distance from the top of the structure to the breakpoint level of the structure, or the applicable zone's minimum side setback requirements, whichever is greater. For example, on a 100-foot tall monopole with a breakpoint at eighty feet (80'), the minimum setback distance would be twenty-two feet (22') (110% of 20 feet, the distance from the top of the monopole to the breakpoint) or the minimum side yard setback requirements for that zone, whichever is greater. Provided, that if an applicant proposes to use breakpoint design technology to reduce the required setback from a residence, the issuance of a permit for the tower shall be conditioned upon approval of the tower design by a Wyoming licensed professional engineer; or
 - (c) The tower is a small wireless facility located within the right-of-way or within a setback adjacent to a right-of-way.
2. All equipment shelters, cabinets, or other on the ground ancillary equipment shall meet the setback requirement of the zone in which it is located.

i. Preferred Macro Cell Tower Locations.

- 1. All new macro cell towers proposed to be located in a residential district or within two hundred feet (200') of a residential district or the Greenway are permitted only after application of the following siting priorities, ordered from most-preferred to least-preferred:
 - (a) City-owned or operated property and facilities not in the residential district or near the Greenway and not including rights-of-way;
 - (b) industrial zones;
 - (c) commercial zones;
 - (d) other non-residential districts;
 - (e) City rights-of-way in residential districts;
 - (f) parcels of land in residential districts;
 - (g) designated historic structures or districts.
- 2. The applicant for a macro cell tower located in a residential district or within two hundred feet (200') of a residential district or the Greenway shall address these preferences in an alternative sites analysis prepared pursuant to the subsection j. below.

j. Submittal Requirements for Alternative Sites Analysis

- 1. For a macro cell tower in a residential district or within two hundred feet (200') of a residential district or the Greenway, the applicant must address the City's preferred tower locations with a detailed explanation justifying why a site of higher priority was not selected. The City's tower location preferences must be addressed in a clear and complete written alternative sites analysis that shows at least three (3) higher ranked, alternative sites considered that are in the geographic range of the service coverage objectives of the applicant, together with a factually detailed and meaningful comparative analysis between each alternative candidate and the proposed site that explains the substantive reasons why the applicant rejected the alternative candidate.
- 2. A complete alternative sites analysis provided under this subsection may include less than three (3) alternative sites so long as the applicant provides a factual written rationale for why it could not identify at least three (3) potentially available, higher ranked, alternative sites.
- 3. For purposes of disqualifying potential collocations or alternative sites for the failure to meet the applicant's service coverage or capacity objectives the applicant will provide (a) a description of its objective, whether it be to or address a deficiency in coverage or capacity (b) detailed maps or other exhibits with clear and concise RF data to illustrate that the objective is not met using the alternative (whether it be collocation or a more preferred location); and (c) a description of why the alternative (collocation or a more preferred location) does not meet the objective.

k. Exceptions to Standards.

- 1. *Applicability.* Except as otherwise provided in this Section (under Site Design Flexibility), no WCF shall be used or developed contrary to any applicable development standard unless an exception has been granted pursuant to this Section. These provisions apply exclusively to conditional use approvals and are in lieu of the generally applicable variance provisions in the Unified Development Code; provided this Section does not provide an exception from this Section's visual impact and stealth design.
- 2. *Procedure Type.* A WCF exception is subject to approval by the Board.
- 3. *Submittal Requirements.* An application for a wireless communication facility exception shall include:

- (a) A written statement demonstrating how the exception would meet the criteria.
- (b) A site plan that includes:
 - (1) Description of the proposed facility's design and dimensions, as it would appear with and without the exception.
 - (2) Elevations showing all components of the wireless communication facility, as it would appear with and without the exception.
 - (3) Color simulations of the wireless communication facility after construction demonstrating compatibility with the vicinity, as it would appear with and without the exception.
- 4. **Criteria.** An application for a wireless communication facility exception shall be granted if the following criteria are met:
 - (a) The exception is consistent with the purpose of the development standard for which the exception is sought.
 - (b) Based on a visual analysis, the design minimizes the visual impacts to residential districts or the Greenway through mitigating measures, including, but not limited to, building heights, bulk, color, and landscaping.
 - (c) The applicant demonstrates the following:
 - (1) The development standard materially limits or inhibits the ability of the applicant or provider to compete in a fair and balanced legal and regulatory environment;
 - (2) The situation can only be addressed through an exception to one or more of the standards in this Section; and
 - (3) The exception is narrowly tailored such that the wireless communication facility conforms to this Section's standards to the greatest extent possible.
- i. **Removal of Abandoned Wireless Communication Facilities.** Any wireless communication facility that is not operated for a continuous period of twelve (12) months shall be considered abandoned, and the owner of such WCF shall so notify the City in writing and remove the same within ninety (90) days of giving notice to the City of such abandonment. Failure to remove an abandoned WCF within said ninety (90) days shall be grounds to remove the WCF at the owner's expense, including all costs and reasonable attorneys' fees. Irrespective of any agreement between them to the contrary, the owner of such unused facility and the owner of a building or land upon which the WCF is located, shall be jointly and severally responsible for the removal of abandoned WCFs and the tower's foundation, if any. If there are two or more users of a single tower, then this provision shall not become effective until all users cease using the tower. A building demolition permit is required for a tower.
- m. **Independent Technical and Legal Review.** Although the City intends for City staff to review applications to the extent feasible, the City may retain the services of an independent technical expert and attorney of its choice to provide evaluations of permit applications for WCFs, when they are subject to conditional use approvals or Administrative Review. The third-party consultants shall have recognized qualifications in the field of wireless communication facilities. The expert's review may include, but is not limited to (a) the accuracy and completeness of the items submitted with the application; (b) the applicability of analysis and techniques and methodologies proposed by the applicant; (c) the validity of conclusions reached by the applicant; and (d) whether the proposed WCF complies with the applicable approval criteria set forth in this Section. The applicant shall pay the cost, not to exceed three thousand dollars (\$3,000) per application review, for any independent consultant fees through a deposit within ten (10) days of the City's request. When the City requests such payment, the application shall be deemed incomplete for purposes of application processing timelines until the deposit is received. In the event that such costs and fees do not exceed the deposit amount, the City shall refund any unused portion within thirty (30) days after the final permit is released or, if no final permit is released, within thirty (30) days after the City receives a written request from the applicant. If the costs and fees exceed the deposit amount, then the applicant shall pay the difference to the City before the permit is issued. The third party shall provide an itemized description of the services provided and related fees and charges.
- n. **Final Inspection.**
 - 1. A certificate of completion will only be granted upon satisfactory evidence that the WCF was installed in substantial compliance with the approved plans and photo simulations.
 - 2. If it is found that the WCF installation does not substantially comply with the approved plans and

photo simulations, the applicant shall make any and all such changes required to bring the WCF installation into compliance promptly.

o. Compliance.

1. All wireless communication facilities must comply with all standards and regulations of the FCC and any State or other federal government agency with the authority to regulate wireless communication facilities.
2. The site and wireless communication facilities, including all landscaping, fencing and related transmission equipment must be maintained at all times in a neat and clean manner and in accordance with all approved plans.
3. All graffiti on wireless communication facilities must be removed at the sole expense of the permittee after notification by the City to the owner/operator of the WCF.
4. If any FCC, State or other governmental license or any other governmental approval to provide communication services is ever revoked as to any site permitted or authorized by the City, the permittee must inform the City of the revocation within thirty (30) days of receiving notice of such revocation.

p. Indemnification. Each WCF located on City property shall be deemed to have as a condition of its approval a requirement that the applicant and provider defend, indemnify and hold harmless the City and its officers, agents, employees, volunteers, and contractors ("City Indemnitees") from any and all liability, damages, or charges (including attorneys' fees and expenses) arising out of claims, suits, demands, or causes of action as a result of the permit process, a granted permit, construction, location, performance, operation, maintenance, repair, installation, replacement, removal or restoration of the WCF; except no indemnity shall be required where the claim arises from the sole negligence or willful misconduct of the City.

q. Eligible Facilities Request.

1. *Purpose.* This Section implements Section 6409(a) of the Spectrum Act (47 U.S.C. Section 1455(a)), as interpreted by the FCC in its Report and Order No. 14-153 and Declaratory Ruling and Third Report and Order released September 27, 2018, which requires a state or local government to approve any Eligible Facilities Request for a modification of an existing tower or base station that does not result in a substantial change to the physical dimensions of such tower or base station.

2. Application Review.

- (a) *Application:* The City shall prepare and make publicly available an application form, the requirements for which shall be limited to the information necessary for the City to consider whether an application is an Eligible Facilities Request. The City may not require an applicant to submit any other documentation intended to illustrate the need for any such wireless facilities or to justify the business decision to modify such wireless facilities.
- (b) *Review:* Upon receipt of an application for an Eligible Facilities Request pursuant to this section, the City shall review such application, make its final decision to approve or disapprove the application, and advise the applicant in writing of its final decision.
- (c) *Timeframe for Review:* Within 60 days of the date on which an applicant submits an application seeking approval of an Eligible Facilities Request under this section, the City shall review and act upon the application, subject to the tolling provisions below.
- (d) *Tolling of the Timeframe for Review:* The 60-day review period begins to run when an application is filed and may be tolled only by mutual agreement between the City and the applicant, or in cases where the City determines that the application is incomplete.
 - (1) To toll the timeframe for incompleteness, the City must provide written notice to the applicant within 30 days of receipt of the application, specifically delineating all missing documents or information required in the application.
 - (2) The timeframe for review begins running again when the applicant makes a supplemental submission in response to the City's notice of incompleteness.
 - (3) Following a supplemental submission, the City will have 10 days to notify the applicant if the supplemental submission did not provide the information identified in the original notice delineating missing information. The timeframe is tolled in the case of second or subsequent notices pursuant to the procedures identified in this Section. Second or subsequent notices of incompleteness may not specify missing documents or information

that was not delineated in the original notice of incompleteness.

- (e) Failure to Act: In the event the City fails to approve or deny a complete application under this Section within the timeframe for review (accounting for any tolling), the request shall be deemed granted provided the applicant notifies the City in writing after the review period has expired.
- r. ***Small Wireless Facilities - Collocation on Existing Structures.***
- 1. *Purpose.* This section implements the 60-day shot clock which is contained in the FCC's Declaratory Ruling and Third Report and Order released September 27, 2018, regarding the collocation of small wireless facilities on existing structures.
 - 2. *Application Review.*
 - (a) Application: The City shall prepare and make publicly available an application form, which form shall be used by the applicant.
 - (b) Reset: Upon submission of an application for collocation of small wireless facilities on an existing structure pursuant to this section, the City shall have 10 days from the submission of the application to determine whether the application is incomplete. Once the applicant files a resubmittal, the shot clock shall then reset to a new 60-day period.
 - (c) Tolling of the Timeframe for Review: Following a supplemental submission, the City shall have 10 days to notify the applicant if the supplemental submission did not provide the information identified in the original notice delineating missing information. The timeframe is tolled in the case of second or subsequent notices. Second or subsequent notices of incompleteness may not specify missing documents or information that was not delineated in the original notice of incompleteness. Tolling may also occur by mutual agreement of the City and applicant.
 - (d) Failure to Act: In the event the City fails to approve or deny a complete application under this section within the timeframe for review, the applicant shall be entitled to pursue all remedies under applicable law.
- s. ***Small Wireless Facilities - Construction (New Structures).***
- 1. *Purpose.* This section implements the 90-day shot clock which is contained in the FCC's Declaratory Ruling and Third Report and Order released September 27, 2018, regarding the construction of small wireless facilities on a new structure.
2. *Application Review.*
- (a) Application: The City shall prepare and make publicly available an application form; which form shall be used by the applicant.
 - (b) Reset: Upon submission of an application for the construction of small wireless facilities on a new structure pursuant to this section, the City shall have 10 days from the submission of the application to determine whether the application is incomplete. Once the applicant files a resubmittal, the shot clock shall then reset to a new 90-day period.
 - (c) Tolling of the Timeframe for Review: Following a supplemental submission, the City shall have 10 days to notify the applicant if the supplemental submission did not provide the information identified in the original notice delineating missing information. The timeframe is tolled in the case of second or subsequent notices. Second or subsequent notices of incompleteness may not specify missing documents or information that was not delineated in the original notice of incompleteness. Tolling may also occur by mutual agreement of the City and applicant.
 - (d) Failure to Act: In the event the City fails to approve or deny a complete application under this section within the timeframe for review, the applicant shall be entitled to pursue all remedies under applicable law.
- t. ***Collocation Applications for Other than Small Wireless Facilities.***
- 1. *Purpose.* This Section implements, in part, 47 U.S.C. Section 332(c)(7) of the Federal Communications Act of 1934, as interpreted by the FCC in its Report and Order No. 14-153, and Declaratory Ruling and Third Report and Order released September 27, 2018.
 - 2. *Application Review.*
 - (a) Application: The City shall prepare and make publicly available an application form, the requirements of which shall be limited to the information necessary for the City to consider whether an application is a collocation request for other than small wireless facilities.
 - (b) Review: Upon receipt of an application for a request pursuant to this section, the City shall review such application, make its final decision to approve or disapprove the application, and advise

the applicant in writing of its final decision.

- (c) **Timeframe for Review:** Within 90 days of the date on which an applicant submits an application seeking approval of a request under this section, the City shall review and act upon the application, subject to the tolling provisions below.
- (d) **Tolling of the Timeframe for Review:** The 90-day review period begins to run when the application is filed and may be tolled only by mutual agreement between the City and the applicant, or in cases where the City determines that the application is incomplete.
 - (1) To toll the timeframe for incompleteness, the City must provide written notice to the applicant within 30 days of receipt of the application, specifically delineating all missing documents or information required in the application.
 - (2) The timeframe for review begins running again when the applicant makes a supplemental submission in response to the City's notice of incompleteness.
 - (3) Following a supplemental submission, the City will notify the applicant within 10 days if the supplemental submission did not provide the information identified in the original notice delineating missing information. The timeframe is tolled in the case of second or subsequent notices pursuant to the procedures identified in this section. Second or subsequent notices of incompleteness may not specify missing documents or information that was not delineated in the original notice of incompleteness.
- (e) **Failure to Act:** In the event the City fails to approve or deny a complete application under this section within the timeframe for review (accounting for any tolling), the applicant shall be entitled to pursue all remedies under applicable law.

u. New Site or Tower Applications.

- 1. *Purpose.* This Section also implements, in part, 47 U.S.C. Section 332(c)(7) of the Federal Communications Act of 1934, as interpreted by the FCC in its Report and Order No. 14-153, and Declaratory Ruling and Third Report and Order released September 27, 2018.
- 2. *Application Review.*
 - (a) **Application:** The City shall prepare and make publicly available an application form, the

requirements of which shall be limited to the information necessary for the City to consider whether an application is a request for a new site or tower.

- (b) **Review:** Upon receipt of an application for a request for a new site or tower pursuant to this section, the City shall review such application, make its final decision to approve or disapprove the application, and advise the applicant in writing of its final decision.
- (c) **Timeframe for Review:** Within 150 days of the date on which an applicant submits an application seeking approval of a request for a new site or tower under this section, the City shall review and act upon the application, subject to the tolling provisions below.
- (d) **Tolling of the Timeframe for Review:** The 150-day review period begins to run when the application is filed and may be tolled only by mutual agreement between the City and the applicant, or in cases where the City determines that the application is incomplete.
 - (1) To toll the timeframe for incompleteness, the City must provide written notice to the applicant within 30 days of receipt of the application, specifically delineating all missing documents or information required in the application.
 - (2) The timeframe for review begins running again when the applicant makes a supplemental submission in response to the City's notice of incompleteness.
 - (3) Following a supplemental submission, the City will notify the applicant within 10 days if the supplemental submission did not provide the information identified in the original notice delineating missing information. The timeframe is tolled in the case of second or subsequent notices pursuant to the procedures identified in this section. Second or subsequent notices of incompleteness may not specify missing documents or information that was not delineated in the original notice of incompleteness.
- (e) **Failure to Act:** In the event the City fails to approve or deny a complete application under this section within the timeframe for review (accounting for any tolling), the applicant shall be entitled to pursue all remedies under applicable law.

- v. **Multiple Sites in One Application.** An applicant may propose no more than ten (10) sites in a batched application. The denial of a site in a batched application shall not affect the approval of any remaining sites.
- w. **Application and Other Fees.** In connection with the filing of an application, the applicant shall pay all application and other fees according to the City’s fee schedule and federal law.
- x. **Laws, Rules and Regulations.** This Section shall be subject to all applicable laws, rules and regulations.
- y. **Severability.** The various parts, sentences, paragraphs, provisions and clauses of this Section are hereby declared to be severable. If any part, sentence, paragraph, provision or clause is adjudged unconstitutional or invalid by a court of competent jurisdiction, the remainder of this Section shall not be affected thereby.
- z. **Conflicts.** These Wireless Communication Facilities regulations are in addition to other regulations in the Unified Development Code. In case of a conflict between regulations, this Section shall control.

- 3. Each house placed in a park or portion of a park developed after the adoption of this code shall have a data plate affixed to it.
- 4. **Skirting.** All houses shall be skirted with a rigid material. Skirting shall be in place within 30 days after the house is set on the space. Skirting shall provide entry access.
- 5. **Utilities.** All spaces in the park shall be provided with utilities meeting standards specified by City, board of public utilities and state regulations and inspected for compliance with those regulations. Each house shall be properly connected to those utilities.
- 6. **Common Storage Areas.** Areas within the park for the storage of boats, trailers, campers and recreational vehicles shall be provided. They shall be screened from adjacent residential properties.
- 7. **Dimensional Standards.** All parks and spaces within parks shall meet the following dimensional standards. Each unit space within the park shall have its boundaries clearly delineated. Accessory structures excluding carports, or any other structure that is open on two or more sides, shall meet these standards.

5.8.2 Manufactured Homes and Parks

- a. **Generally.** Housing that meets the definition of a manufactured home shall be permitted in any residential district provided it meets the specific standards of this section, the standards for that district and all other applicable construction standards.
- b. **General Standards.** Manufactured housing parks shall be permitted only as a use requiring public hearing in any residential district or as a planned unit development, and shall meet all other applicable requirements of the zoning district.
 - 1. Any property to be used as a manufactured housing park shall comply with the minimum standards governing the parks as adopted and maintained by the Department of Public Health for the state of Wyoming and only after certification of compliance and a permit have been duly issued.
 - 2. Any property to be developed as a manufactured housing park shall be platted as required by the subdivision regulations for the City.

<i>Dimension</i>	<i>Minimum Requirement</i>	
<i>Minimum Total Area</i>	5 acres	
<i>Park Density</i>	9 units per acre for units up to 750 square feet; 7 units per acre for units over 750 square feet	
<i>Lot space area per dwelling unit</i>	3,000 square feet	
<i>Lot frontage per dwelling unit (frontage)</i>	32'	
<i>Setbacks*</i>	<i>Front</i>	10'
	<i>Side</i>	15' on main entry side; 20' total both sides (may be allocated to one side for zero-lot line lots)
	<i>Public Street</i>	25'
	<i>Other Dwelling</i>	20'

* In instances where the zoning district setback requirements are more restrictive, the district standards shall be used as the minimum setbacks from all property lines.

- c. **Roadway Standards.** Park roadways shall be paved and meet the following dimensional standards:

Roadway Type*	Minimum Requirement
One-way streets	38' roadways 28' of pavement
Cul de sacs	400' maximum length from start to center point of turning circle 35' roadway 25' pavement
Other Roadways	40 feet roadways 32 feet pavement

* Any street that connects two public streets shall be built to the standards of Article 4, Section 4.3.

- d. **Walkways, lighting and parking standards.**
1. Walkways. All houses shall be connected to the adjacent park roadway via a hard-surfaced walkway. The vehicle parking pad may be used as a portion of this walkway. Hard-surfaced walkways shall be provided within the park roadway as follows:
 - (a) Minor park roadways (roadways serving 25 units or less) shall have a walkway on at least one side of the park roadway.
 - (b) Major park roadways (roadways serving more than 25 units) shall have a walkway on both sides of the park roadway.
 2. Lighting. All park roadways and walkways shall be adequately lit to provide for the safety of park residents.
 3. Parking. Two off-street parking stalls shall be provided per unit space.
- e. **Recreation Space.** For the purposes of this section, "recreation space" is defined as an area of land that is available to park residents for recreational activities. It does not include roadways, storage areas or yards. For parks with more than 25 spaces, or additions to those parks, recreation space shall be provided as follows:

Average Lot Size	Required Recreation Space
3000 to 3,999 square feet	8% of gross park area
4,000 to 4,999 square feet	4% of gross park area
5,000 square feet or more	No requirement

- f. **Existing Manufactured Home and Manufactured Home Parks.** An existing house or park that does not meet the definition of a manufactured home or park as outlined in this Title shall be deemed to be a nonconforming use without regard to the standards of the district in which it is located. The nonconforming use may be continued provided that the continued use does not constitute a hazard to health and is not a public nuisance. The nonconforming use shall not be extended, enlarged, or changed unless the entire home or park is brought into compliance with current regulations for manufactured homes or new manufactured home parks. For a manufactured home park, the procedures shall be the same as those for establishing a manufactured home park in that district. In addition to the information and application for the district, the request shall also contain the following information:

1. A draft written agreement from the applicant to insure that the improvements to the new area and the improvements to the existing area will be provided;
2. A specific time schedule for all the improvements;
3. A specific list of exceptions to the standards for new parks that cannot or will not be met when all improvements specified in the agreement are provided.

Expansion of the park and the installation of improvements will not be initiated until the agreement and the other requirements of the district have been approved.

- g. **Travel Trailers and Recreational Vehicles.** Travel trailers and recreational vehicles shall not be installed in manufactured housing parks or subdivisions as a dwelling unit. The use of travel trailers and recreational vehicles shall be allowed only in campgrounds, mobile home parks or combined parks as defined in the state of Wyoming Mobile Home Park and Campground regulations.

- h. **Manufactured Homes on Single Platted Properties or Tracts.** Manufactured homes are permitted on any platted residential property or tract subject to the provisions of this section. This section does not apply to homes placed in manufactured home parks. Homes to be placed on a property or tract shall meet the following requirements:
1. The home shall be sited in such a fashion that it meets all the requirements of the district in which it is located.
 2. The home shall have the delivery system removed. The home shall be installed on a permanent foundation constructed of masonry, concrete or other approved material and shall comply with the building code. The

foundation system shall be designed and constructed to sustain, within the stress limitations specified in the building code, all loads specified in the building code. The installation instructions as provided by the manufacturer of the manufactured home shall be used to determine permissible points of support for vertical loads and points of attachment for anchorage systems used to resist horizontal and uplift forces. The foundation system design shall be stamped and signed by a Wyoming licensed professional engineer.

3. The house shall be built to the current HUD code for this zone as referenced in the federal manufactured housing construction and safety standards. Skirting and permanent perimeter enclosures shall be installed. Skirting shall be of material suitable for exterior exposure and contact with the ground. Permanent perimeter enclosures shall be constructed of materials as required by the building code for regular foundation construction. Skirting shall be installed in accordance with the skirting manufacturer's installation instructions. Skirting shall be adequately secured to assure stability, to minimize vibration and susceptibility to wind damage, and to compensate for possible frost heave.
4. Where retaining walls are used as a permanent perimeter enclosure, they shall resist the lateral displacements of soil or other materials and shall conform to the building code as specified for foundation walls. Retaining walls and foundation walls shall be constructed of approved treated wood, concrete, masonry or other approved materials or combination of materials as for foundations as specified in the building code. Siding materials shall extend below the top of the exterior of the retaining or foundation wall or the joint between siding and enclosure wall shall be flashed in accordance with the building code.
5. The structure shall have a pitched roof, with a slope of not less than a nominal three inch vertical rise for each twelve (12) inches of horizontal run. Roof material shall consist of nonreflective material customarily used for conventional dwellings including but not limited to fiberglass shingles, composition shingles or tile material. Roof materials shall not include flat or corrugated sheet metal, except for manufactured metal roof panels.
6. The structure shall have a roof overhang of not less than eight inches measured from the vertical side of the home.
7. The structure shall have siding material consisting of wood or wood products, stucco, brick, rock, horizontal lap steel or aluminum or horizontal lap vinyl.
8. The structure shall be a minimum of 24' along the widest part of the structure's shortest axis.
9. The structure shall be constructed in accordance with the most recent version of the HUD code. However, no home will be permitted under this section if it was built prior to the year 2000.

5.8.3 Drive-through Facilities

Where any use provides drive-through facilities as an element of the site and building design, the following specific conditions shall apply.

- a. **Queuing Area.** Sufficient dedicated queuing areas shall be provided for vehicles awaiting service.
 - (1) A minimum queuing area of 60 feet shall be provided at each service area where a vehicle may stop. A lesser queuing area may be approved by the Director. The Director may require a transportation analysis or study to make this determination.
 - (2) Minimum required queuing areas shall not intersect with any required pedestrian connection on the lot or in the public right-of-way.
 - (3) Queuing areas and service areas or facilities shall be setback at least 30 feet from any right-of-way line.
- b. **Residential Buffers.** Any service area or facility shall be oriented away from and fully screened from any property that is residentially zoned or used solely for residential purposes. No speaker, sign, or service window shall be audible or visible from any property zoned for or used solely for residential purposes. All elements of the drive-through within 100 feet of residentially zoned property shall require a Level 3 landscape buffer according to Section 6.3. All elements of a drive-through 100 feet or more from residentially zoned property, but on lots abutting residentially zoned property shall require a Level 2 landscape buffer according to Section 6.3. Alternative buffers may be approved by the Director as specified in Section 6.3.
- c. **Pedestrian-Area Limitations.** In the NB, CBD, MUR, MUB, or any situation where the Small-scale Commercial and Mixed-use Design Standards in Section 6.7 apply, any drive through facility shall meet the following additional standards.
 - (1) No more than 2 drive-through facilities may be located on a single block, except that where block orientation, lot arrangements and site designs allow all drive-

through facilities to be separated by at least 250', more than 2 may be permitted.

- (2) Any use providing drive-through services shall also provide at least one pedestrian walk-up service area, or some other additional pedestrian amenity or facility. Exterior pedestrian service windows, vestibules, or buildings with internal service areas frequented by pedestrians may count towards this requirement.

5.8.4 Fences

a. **Design Standards.** Within all residential zoning districts (AR, LR, MR, HR, NR-1, NR-2, NR-3, MUB, MUR, MUE), residential uses within non-residential zone districts, and the CBD District:

- 1. Fences are limited to a maximum of four (4) feet in height in any front yard setback. The front yard setback is defined as the area between the front property line and the front building line of the principal building.
- 2. Fences may be a maximum of six (6) feet in height behind the front building line of the principal building.
- 3. The height of the fence is measured from the top of the fence to the finished grade of the lot directly under the fence or wall as such grade existed at the time the fence or wall was constructed. Any berm, wall or similar feature that is constructed for the purpose of increasing the height of a fence or wall shall be considered to be a part of the fence or wall. When a fence or wall is located on sloping ground constructed perpendicular to the slope and not parallel to the slope, the height shall be measured at the mid-point of each fence section.

- 4. Materials.
 - (a) Fencing within residential zone districts shall be constructed of brick, stone, wood, vinyl, wrought iron, concrete block, or chain link.
 - (b) Alternative materials, as approved by the Board of Adjustment through the Conditional Use process, may be allowed.
- 5. Exceptions.
 - (a) Fences may be constructed above seven feet for recreational uses including tennis courts, volleyball courts, swimming pools, golf driving ranges, goals and backstops, and similar uses. These fences shall conform to all other setbacks in the district.
 - (b) Fences may be constructed above four (4) feet in height, but no more than six (6) feet in height, for the purpose of screening utilities and mechanical systems.

b. **Other Restrictions.** Applies to all zone districts.

- 1. Fences shall not be allowed within any right-of-way, unless specific "written" approval is given by the City Engineer.
- 2. Fences shall not be constructed within any applicable sight triangle or vision clearance established in these regulations.
- 3. No fence shall be constructed which hinders or obstructs access to any fire hydrant or is within a 3' radius of any fire hydrant.
- 4. No fence shall be constructed within 2' of any public sidewalk or Greenway.

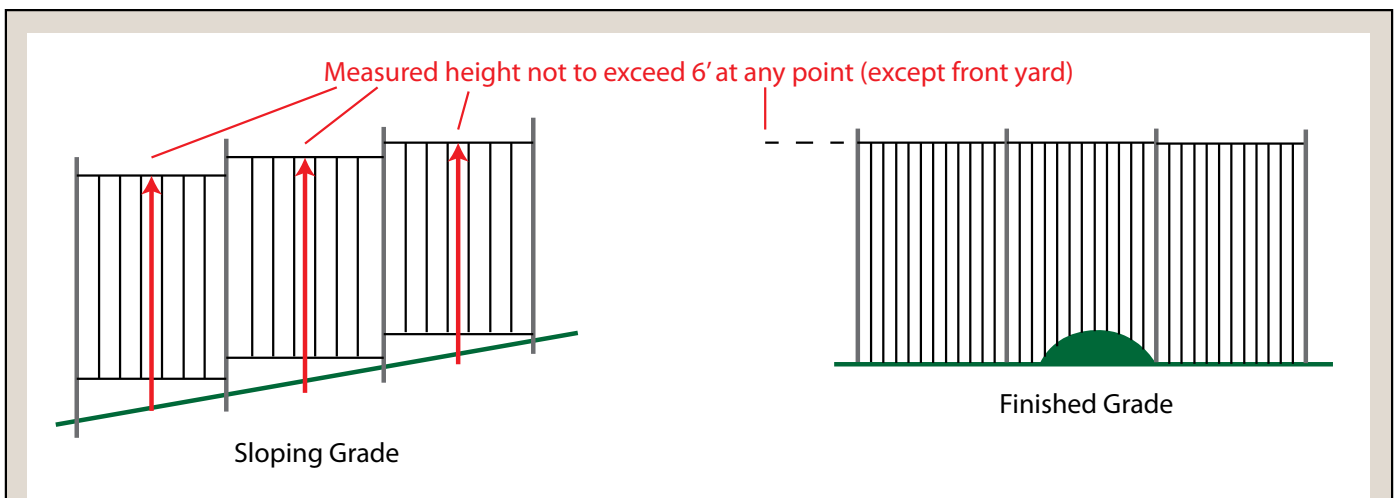

Figure 5-1: Fence Measurement

5.8.5 Refuse Containers

In addition to any other applicable site design standards in Article 6, all trash containers shall be placed behind the building setback line from all streets, and screened with solid material from view from all streets. All uses shall be required to provide trash containment consistent with these requirements except for detached, semi-attached and attached dwelling which have only the following limitations:

- a. Containers may not be stored in the public right of way associated with a public street and no case stored within 10' of any public sidewalk.
- b. The storage area shall be partially screened from view from the public right of way with vegetation or fencing that is compliant with fencing limitations.
- c. Storage does not include times when a refuse container is moved to the curb area for scheduled collections. This time frame shall not exceed 48 consecutive hours.

5.8.6 Outdoor Storage

Where Outdoor Storage is allowed, the storage area shall be screened from all adjacent streets with a Level 3 buffer as described in Section 6.3.5, Table 6-11. Where Outdoor Storage is allowed in the BP zone district, the storage area shall be screened from all adjacent streets with a 6' wall or solid fence (a landscape buffer is not required).

5.8.7 Oil and Gas Support Services

An entity wishing to provide oil and gas support services, including land uses which provide support service for oil and gas drilling operations such as parking and storage of exploration, production or workover equipment, pipe and production equipment, equipment and storage yards for road and pipeline construction contractors and production unit setup, may request a Special Use Approval from the Governing Body to temporarily defer all or a portion of the development requirements in the Cheyenne City Code, including landscaping requirements, right of way improvements, parking lot surface paving, and connection to City water or sewer. A Special Use Permit is only available for property within the Heavy Industrial -HI Zone District. Property proposed for the oil and gas support service option shall submit an application in accordance with the Special Use Approval as described in Article 2.

- a. **Requirements.** A site approved for a Special Use Permit shall be subject to the following requirements:
 - 1. No permanent facilities, including uses that would require restrooms, may be located on the site at the time of application or after approval.
 - 2. Outdoor storage of all materials stored, or to be stored, shall be screened from the view of the adjacent public right-of-way and adjacent properties.
 - 3. Screening shall be accomplished through the use of a solid fence or wall or through the use of landscape ing (including plant materials and/or berms) that provides year-round screening, or through a combination of fencing, walls and landscaping. Any landscaping shall meet appropriate maintenance standards.
 - 4. No maintenance activities shall be permitted. Maintenance is defined as any activity related to upkeep of vehicles or equipment that has a potential of causing the discharge of chemicals, lubricants, or other hazardous substances onto the ground.
- b. **Effect of Decision.** The construction of any permanent facilities on a Special Use Permit site shall invalidate the Special Use Permit, and the applicant shall be required to improve the site according to City Code. Approval of the application shall be valid for up to 18 months, with a 6 month extension available by written request to the Director prior to the end of the initial period. In no event shall the Special Use Permit be valid more than 2 years. At the conclusion of the special Use Permit period, the applicant shall either implement the approved site plan or vacate the premises in accordance with the Special Use Permit.
- c. **Submittal.** In addition to the requirement described for a special use approval in Article 2, applicants for a Special Use Permit for Oil and Gas Support Services shall submit the following for review and approval:
 - 1. A site plan depicting all currently required standards and including traffic and drainage studies as required, including but not limited to landscaping, right-of-way improvements and screening. The site plan shall identify all site improvements that the applicant seeks to defer under the Special Use Permit.
 - 2. An application for a Special Use Permit, Oil and Gas Support Services.
 - 3. A bond or other financial security to guarantee restoration of the site to its original condition following the expiration of the Special Use Permit, if required by the City Engineer.

5.8.8 Accessory Buildings

Accessory buildings associated with residential uses shall meet the following standards:

- a. There shall be a principal building constructed on the site prior to an accessory building being permitted.
- b. For double frontage, triple frontage and corner lots, the setback for a wall with vehicular access parallel to the adjacent right-of-way shall be 25'; otherwise the setback for double frontage, triple frontage and corner lots shall be half of the required principal building's front setback.
- c. Accessory buildings under 200 sq. ft. shall be allowed a side and rear setback of 0-feet.
- d. An accessory building shall not encroach on any recorded easement.
- e. Up to two accessory buildings shall be allowed per lot.
- f. The maximum total building footprint of all accessory buildings shall be equal to or less than 15% of the property area.
- g. Accessory Buildings shall not have a larger building footprint than the principal buildings enclosed footprint (porches and decks do not count toward the principal buildings footprint).
- h. Exceptions to accessory building height, area, and number may be approved by conditional use approval pursuant to UDC 2.2.4.
- i. The provisions of subsections (a), (b), (e), (f), and (g) of this section do not apply to accessory buildings approved in conjunction with a site plan.
- j. To be considered a separate building, the structures must not share any structural attachment and no part of either building may be within 3' of the other when viewed from plan view. Two structures closer than 3' or with a structural attachment shall be considered one building for the purposes of setback, area, and number.

This page is intentionally left blank.

ARTICLE 6 DESIGN REGULATIONS

6

Article 6, Design Regulations provides standards that deal with coordinating components of development on an individual site in a manner that reinforces the character of districts and neighborhoods. It includes standards for site elements that apply to all districts and sites regardless of use or zoning district, as well as standards for specific districts that require unique design considerations and solutions. It is most useful to development and design professionals and City staff.

UNIFIED DEVELOPMENT CODE

ARTICLE 6 DESIGN REGULATIONS

- 6.1 General Provisions
- 6.2 Parking, Lot Access and Circulation
- 6.3 Landscape Standards
- 6.4 External Lighting
- 6.5 Signs
- 6.6 Residential Design Standards
- 6.7 Small Scale Commercial and Mixed-use Design Standards
- 6.8 Large Scale Commercial Design Standards
- 6.9 General Commercial Design Standards

6.1 General Provisions

- 6.1.1 Intent
- 6.1.2 Site Design Elements

6.1.1 Intent

The intent of the design standards in this Article 6 are:

- a. To create effective transitions from public areas to private areas of sites, and between adjacent sites along streetscapes.
- b. To coordinate site development with streetscape and street design requirements, whether the streetscape and street design types are existing, constructed in association with development, or planned or programmed as future City improvements.
- c. To coordinate development efficiently across adjacent sites including consideration for existing conditions and planned or anticipated development on these sites.
- d. Ensure that individual sites are developed in an efficient and coordinated manner, meeting all of the design requirements of this Title, and designed to most effectively meet the multiple purposes, intents, and design objectives of the various sections.

6.1.2 Site Design Elements

This Article addresses the following specific design elements, present on most sites and in most districts. The standards apply in addition to all general standards of Article 4 and 5.

- a. Parking, Lot Access and Circulation Standards, coordinating parking and lot access requirements for vehicles with pedestrian access.
- b. Landscape Standards, including area, location, and plant material requirements.
- c. External Lighting Standards;
- d. Sign Standards; and
- e. Special design standards for mixed-density neighborhoods, small-scale commercial and mixed-use development, and large-scale development. Where these standards apply, they address the following additional elements of coordinated site design.

- 1. Streetscapes and Lot Frontages;
- 2. Open Space Design;
- 3. Building Design; and
- 4. Site Screening.

6.2 Parking, Lot Access and Circulation

- 6.2.1 Design Objective
- 6.2.2 Applicability
- 6.2.3 Lot Access and Circulation
- 6.2.4 Required Parking
- 6.2.5 Shared Parking
- 6.2.6 Parking Credits
- 6.2.7 Maximum Parking
- 6.2.8 Parking Design

6.2.1 Design Objective

The Design Objective for the parking, lot access and circulation requirements is to:

- a. Emphasize the importance of site accessibility from a variety of modes of transportation wherever appropriate, including pedestrians, bicycles, automobiles, and any current or potential future transit service.
- b. Provide the optimal amount of vehicle parking for individual sites, recognizing that both too little parking and too much parking create negative impacts.

ARTICLE 6

DESIGN REGULATIONS

6.2 PARKING, LOT ACCESS AND CIRCULATION

- c. Ensure the appropriate site location and design features that mitigate the impact of parking lots on other land uses and urban design goals for surrounding districts.
- d. Create the least visible impact of parking on adjacent private and public property.
- e. Promote parking designs that minimize runoff and incorporate infiltration of stormwater into the ground.
- f. Reduce the need to dedicate areas of individual, adjacent sites to underutilized or redundant vehicle parking.

6.2.2 Applicability

- a. **General Applicability.** General Applicability. The standards in this section shall apply to all new construction and changes of use in all zoning districts, except that no parking is required in the CBD, SS, or BP districts or the UU Overlay District. When sites do elect to provide parking in the CBD, SS, or BP districts or the UU Overlay District, all maximum quantity, location, design standards and specific limitations in this Article shall apply.
- b. **Change of Use.** When a new use proposed for a site requires more parking than the existing use according to this section, the new use shall be responsible only for the additional parking required. Any existing parking deficiencies of the required parking for the most recent use may be credited to the new use at the Director's discretion, provided it is reasonably necessary to promote effective infill development. The new use shall be responsible for the additional parking beyond any existing or credited parking.
- c. **Expansion of Existing Parking.** When any existing parking area is expanded, by operation of these standards or by election of the property owner, all design and location standards in this section shall apply to the new parking. Where the proposed expansion is more than 50% of the existing capacity, the design and location standards shall apply to the entire lot. No existing parking may be expanded beyond the maximum quantity specified by this section.

6.2.3 Lot Access and Circulation

- a. **Driveways.** All driveways to individual sites shall be limited to the access point standards in Article 4, Section 4.3.6, based on the street type of the abutting street. All situations where a sidewalk or pedestrian facility intersects

with an internal vehicle circulation shall be treated by one of the following manners:

1. The material, layout and grade of the pedestrian access shall be continuous as it crosses the grade of the driveway; or
2. A crosswalk differentiated from vehicle surfaces by different materials, texture or color, or a speed table. Where crosswalks would exceed 32', curb projections may be used to shorten pedestrian crossing distances. Crossings of driveways that exceed 32' shall be treated as intersections according to the design and location standards in section 4.3.5.

- b. **Internal Access Ways.** Any single block, lot or development site larger than 5 acres shall provide a system of internal access ways to establish connectivity and mobility within

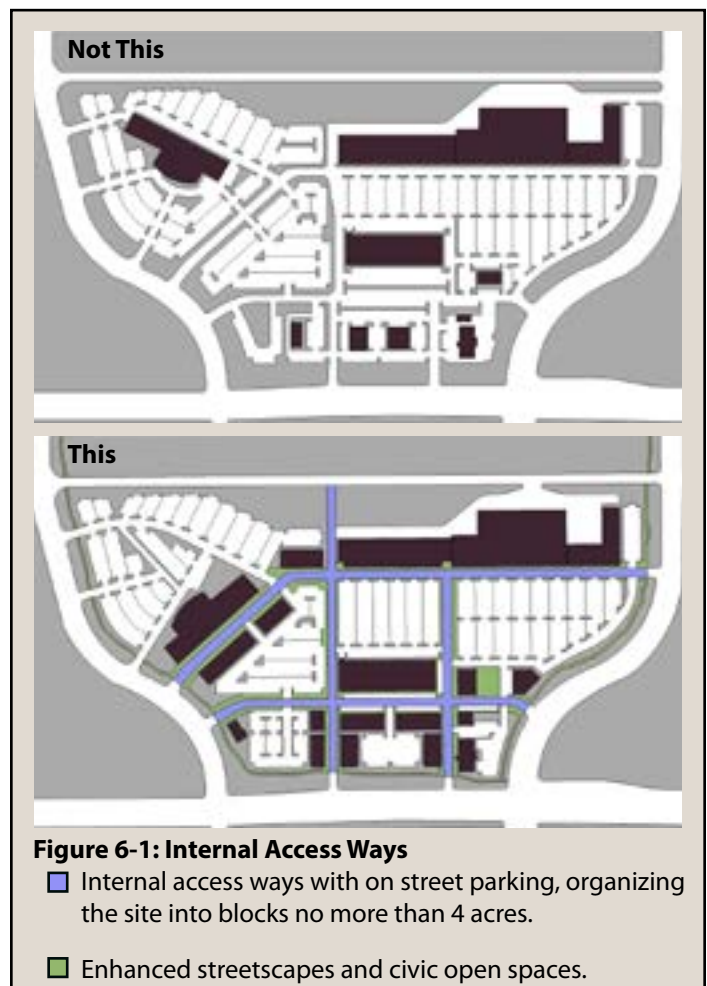

the site and coordinate with streets and blocks adjacent to the site. Internal access ways shall:

1. Be designed according to the public street design standards in Article 4, including the standards for vehicle lanes, parking lanes, and streetscape design;
2. Organize the site into smaller “blocks” between 1 and 4 acres for buildings, open space, and parking; and
3. Be treated as public streets for interpretation and application of setbacks, build-to lines, curb cuts and driveway access, and building and lot frontage standards. Build-to or setback lines shall be calculated from the outside edge of the sidewalk along internal access ways.

c. **Pedestrian Access and Circulation.** All development sites shall include direct pedestrian connections and circulation routes at the same or greater frequency as is provided by streets, driveways, and internal access streets.

1. *Generally.* At a minimum, pedestrian access and circulation within a site shall provide dedicated pedestrian facilities directly connecting each of the following:
 - (a) All public entrances of all buildings;
 - (b) The public sidewalk on adjacent streets or internal access streets;
 - (c) On-site parking areas;
 - (d) Required open space and other site amenities; and
 - (e) Adjacent sites, where pedestrian access between sites via the sidewalks on streets or internal access streets is remote.
2. *Sidewalk widths.* Internal sidewalk widths shall meet the following requirements:

materials for not less than 50% of its length.

- (b) Sidewalks shall be located an average of 8’ from the facade of the building to provide planting beds for foundation landscaping, except where features such as arcades, display windows or entryways are part of the facade.
- (c) Internal pedestrian walkways provided in conformance with this sub-section shall provide weather protection features such as awnings or arcades located no further than 30’ from all customer entrances.
- (d) To the extent feasible, pedestrian traffic should be separated from vehicles. If not feasible, potential hazards shall be mitigated using the following strategies:
 - (1) Use of special paving, pavement markings, signs, striping and/or bollards;
 - (2) Use of median refuge areas, traffic calming features, and landscaping;
 - (3) Use of lighting or other means to clearly delineate pedestrian areas, day and night.

6.2.4 Required Parking

a. **Automobile Parking.** The minimum requirements for off-street parking facilities in Table 6-2 are general and are intended to include all similar uses. Where the classification of use is not determinable from the table, the Director shall determine the appropriate classification. The most current version of the ITE Parking Generation standards, APA parking surveys or other similar guidance may be used to aid in the determination of the most appropriate classification. Additional standards for specific zoning districts or specific uses may apply in addition to this table. Each fractional space shall be rounded up to the next whole number.

<i>Location</i>	<i>Minimum Width</i>
<i>In general</i>	5'
<i>Along any building façade abutting a parking area or along parking with vehicle overhangs</i>	8'
<i>Along any building façade with a primary entrance</i>	10'; 12' when associated with Section 6.7

3. *Pedestrian Amenities.*
 - (a) Pedestrian walkways shall feature adjoining landscaped areas that include trees, shrubs, benches, flower beds, ground covers or other

ARTICLE 6

DESIGN REGULATIONS

6.2 PARKING, LOT ACCESS AND CIRCULATION

TABLE 6-2: REQUIRED AUTOMOBILE PARKING

Use	Parking Spaces
Assembly (auditorium, stadium, church, etc.)	1 space per each 5 seats (maximum capacity)
Bed and breakfasts, boardinghouse and/or lodging house	1 space per each 2 bedrooms
Hospitals	2 spaces per each bed
Hotels and motels	1 space for each rental unit plus 1 space for each 2 employees at maximum employment on a single shift Plus 1 space for each company vehicle regularly parked on the premises Accessory uses (dining, banquette) shall satisfy their parking requirement separately according to this table.
Industrial and Warehousing	1 space for each two employees at maximum employment on a single shift Plus 1 space for each company vehicle regularly parked on the premises
Nursing homes and assisted living facilities	1 space for each 5 beds for shared living facilities 1 space for each 3 independent living units Plus 1 space for each employee at maximum employment on a single shift Plus 1 visitor space for every 10 beds or 5 independent living units
General offices	< 50,000 square feet: 1 space per 300 square feet ≥ 50,000 square feet: 1 space per 400 square feet
Medical offices	1 space per 200 square feet
Residential: Detached, Semi-Attached, and Attached Dwellings	2 spaces per dwelling unit
Residential: all others	1.0 space per unit for studio or one bedroom 1 space per unit for age restricted senior housing 1.5 spaces per dwelling unit
Retail - generally	< 25,000 square feet: 5 spaces per 1,000 square feet 25,000 to 400,000 square feet: 4 spaces per 1,000 square feet 400,000 to 600,000 square feet: 4.5 spaces per 1,000 square feet > 600,000 square feet: 5 spaces per 1,000 square feet
Retail – Large product sales (automobiles, RVs, boats, farm implements, appliances, tree nurseries and garden centers, etc.)	1 space per 20,000 square feet
Restaurants	< 2,000 square feet: 5 spaces per 1,000 square feet 2,001 - 5,000 square feet: 10 spaces per 1,000 square feet > 5,000 square feet: 20 spaces per 1,000 square feet Plus 1 space per each 2 employees at maximum employment on a single shift.
Schools	<i>K through 9</i> : 1 space for each 15 students at maximum capacity <i>10 through 12</i> : 1 space for each 4 students at maximum capacity <i>College and technical schools</i> : 1 space for each 2 students at maximum capacity
Family Child Care Center (FCCC)	1 space per employee 1 visitor space
Child Care Center (CCC)	1 space per employee 1 space for each 20 children at maximum capacity Plus 2 required spaces

- b. **Exceptions.** The following exceptions apply to interpreting the required parking in Table 6-2, and are in addition to all other provisions for flexibility and discretion in this Section.
1. The Director may grant a reduction of up to 10% of required parking in this table based on specific site conditions, the nature of the proposed use, and finding that the exception will not cause long-term parking issues for adjacent property or anticipated future uses.
 2. Parking requirements for buildings in historic districts, where site and building conditions existed prior to zoning or parking requirements, may be reduced by 50% by the Director through the Administrative Adjustment procedures and criteria in Article 2.
 3. All other reductions over 10%, except as otherwise provided by the standards and credits in this Section, shall be considered by the Board according to the variance procedures in Article 2. The Board cannot reduce required parking through variance action by more than 50%, except for redeveloping properties. For those redeveloping properties, the Board shall take into account the proposed use, anticipated number of employees, the anticipated number and frequency of customers or clients, the availability of nearby on-street parking and the availability of shared parking.
- c. **Bicycle Parking.** All new uses and changes of use shall provide at least 1 bicycle parking space. The following bike parking spaces are recommended for all new uses or change of use permits at the rates provided. This table shall also be used as a guide in determining the sufficiency of bicycle parking when applying the bicycle parking credit in subsection 6.2.6.

Use	Parking Spaces
Primary or Secondary School	10% of the number of students at maximum capacity; and 3% of the number of employees
College or University Classrooms	3% of the number of students at maximum capacity; and 1% of the number of employees
Retail and Office	10% of the required automobile spaces
Sports and Recreation Center	5% of the number of automobile spaces
Movie Theater or Restaurant	5% of the number of automobile spaces
Industrial	2% of the number of automobile spaces
Multi-dwelling Housing	1 space per 2 units
Public Transit Stations	Varies based on usage

- d. **Accessible Parking.** The number, location, dimensions, and signing of accessible parking stalls shall be in accordance with the current ADA Standards for Accessible Design.

6.2.5 Shared Parking

In meeting the requirements of Table 6-2, adjacent land uses, lots, or sites may share parking under the following conditions and standards:

- a. All landowners participating in the shared parking shall execute the necessary cross-access easements to facilitate shared parking and record all documents for the easements with the County.
- b. A written agreement for the joint use of parking facilities shall be executed by the parties and approved by the City.
- c. All shared parking spaces shall be within a reasonable proximity of the main entrance of any building sharing the parking and provide direct pedestrian access to the entrance either by way of pedestrian alleys and passages, or by way of public sidewalks in the streetscape. In general, locations greater than 600' from the site utilizing the shared parking shall not qualify unless exceptional circumstances justify.
- d. Parking requirements shall be the cumulative requirements of the uses sharing the parking, except where different categories of uses (Retail or Service, Employment, Civic, or Dwellings) are participating in the sharing agreement and are likely to generate distinctly different times of peak parking demand. The following table is a base guide for shared parking. Each use should provide a percentage of parking required by these regulations according to Table 6-4 Shared Parking. Whichever time period requires the highest total parking spaces among the various uses should be the amount of parking provided subject to the shared parking agreement. Alternative parking allocations may be approved by the Director based on industry data or other sufficient evidence and analysis of peak parking demands for specific uses.
- e. Guidelines for Preparing a Joint Parking Study in Appendix F shall be used in administering this section.

ARTICLE 6

DESIGN REGULATIONS

6.2 PARKING, LOT ACCESS AND CIRCULATION

TABLE 6-4: SHARED PARKING

Land Use	Percentage of Required Parking Spaces by Time Period				
	Weekday Day & Evening		Weekend Day & Evening		Nighttime
	6 AM TO 5 PM	5 PM TO 1 AM	6 AM TO 5 PM	5 PM TO 1 AM	1 AM TO 6 AM
Employment	100 %	10 %	5 %	5 %	5 %
Retail or Service	75 %	75 %	100 %	90 %	5 %
Restaurant	50 %	100 %	75 %	100 %	25 %
Entertainment & Recreation	30%	100 %	75 %	100 %	5 %
Church	5 %	25 %	100 %	50 %	5 %
School	100 %	10 %	10 %	10 %	5 %
Dwellings	25 %	90 %	50 %	90 %	100 %
Lodging	50 %	90 %	75 %	100 %	100 %

6.2.6 Parking Credits.

A credit may be given to the parking requirements in Table 6-2 under the following conditions. The credits may be cumulative.

- a. **On-street Parking Credit.** On-street parking may be credited to the parking requirement at a rate of one credit for every on-street parking space abutting the lot. On-street parking spaces within the distance parameters may be counted more than once by multiple users.
- b. **Bicycle Parking Credit.** Bicycle parking facilities within 200' of the primary building entrance may be credited at a rate of one credit for every four bicycle parking spaces, up to a maximum of 10% percent of the required vehicle parking. The applicant shall provide sufficient justification that the site can be reasonably accessed by bicycles and that land uses on the site can generate bicycle access in order to receive the bicycle parking credit. The bicycle parking requirements in Table 6-3 shall be used to determine the sufficiency of bicycle parking in applying the credit. Guidelines in Appendix E Pedestrian and Bicycle Guidelines shall be used to determine the appropriate location, design and type of bicycle parking facilities.
- c. **Public Parking Credit.** Public parking within 600' of any lot line may be credited at a rate of one credit for every three public parking spaces. The City or other public entity in charge of management of the public parking facilities reserves the right to restructure the eligibility for parking credits through a parking district management program, subject to approval of the City Council.
- d. **Transit Access Credit.** Any use within 600' of a public transit stop or station may propose that the parking requirements be reduced by up to 10%. The Director may approve the credit based on an assessment of the mix of uses, the accessibility and frequency of transit routes, and the likelihood of the proposed use in generating transit ridership.

e. **Carpool.** Parking reserved for carpool vehicles within 200' of the primary building entrance may be credited at a rate of two space credits for every space reserved for carpool vehicles up to a maximum of 5% of the required vehicle parking.

f. **Fuel Efficiency.** Parking reserved for fuel efficient vehicles within 200' of the primary building entrance may be credited at a rate of one space credit for every two spaces reserved for fuel efficient vehicles up to a maximum of 5% of the required vehicle parking. The intent of the credit is to promote fuel efficiency and is enforced by the property owner.

g. **Motorcycle.** Parking reserved for motorcycles within 200' of the primary building entrance may be counted at the same rate as standard parking spaces up to a maximum of 5% of the required parking. The benefit to the motorcycle spaces is they may be more narrow than standard spaces. The purpose of this credit is to promote fuel efficient vehicles.

h. **Permeable parking area.** Where over 10% of the surface area of the required parking is a porous surface that allows stormwater to be infiltrated below the surface and the treatment is approved by the City Engineer, the Director may approve a reduction of up to 10% of the required parking. Any porous surface used shall demonstrate that it has at least the same or better performance standard as the required standard parking surface and does not present substantial maintenance issues.

6.2.7 Maximum Parking

- a. No use shall provide more than 25% percent over the minimum required parking in Table 6-2 without exhausting all options for Parking Credits or Shared Parking, and shall only be permitted by the Director to exceed 25% above the minimum requirements,

ARTICLE 6

DESIGN REGULATIONS

6.2 PARKING, LOT ACCESS AND CIRCULATION

up to 125% of the minimum parking requirement, by incorporating two or more of the mitigating design features of subsections 6.2.7.c. below.

- b. The Director may grant an exception to the maximum parking requirements of this section, provided the Applicant submits a parking study prepared by a Wyoming licensed engineer justifying the need for such additional parking. Such parking study shall be reviewed and approved by the City Engineer. The following criteria shall be reviewed in evaluating the parking study:
1. projected employees,
 2. employee density,
 3. building and/or occupancy capacity,
 4. projected peak attendees/customers,
 5. availability of parking on adjacent streets,
 6. parking turnover rate, and
 7. average peak period parking demand.

In conjunction with any exception granted under this subsection, the Applicant shall incorporate mitigating design feature 6.2.7.c.1 and one additional mitigating design feature of subsection 6.2.7.c.

c. Mitigating Design Features

1. Landscape material requirements for the site shall be increased by 15% percent above the minimum amount required in the Landscape Design standards of Section 6.3 and shall be allocated to provide enhanced buffering of all on-site parking.
2. The site shall be required to provide additional area,

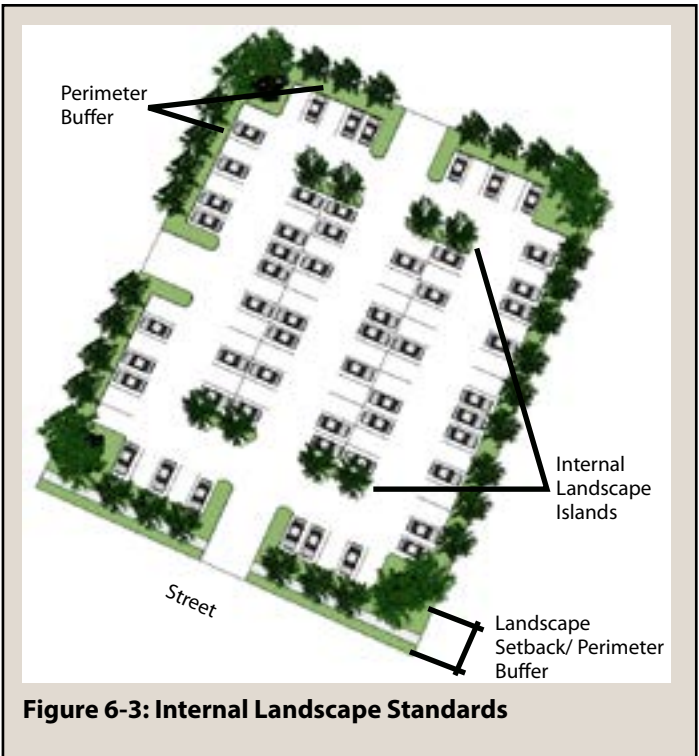

Figure 6-3: Internal Landscape Standards

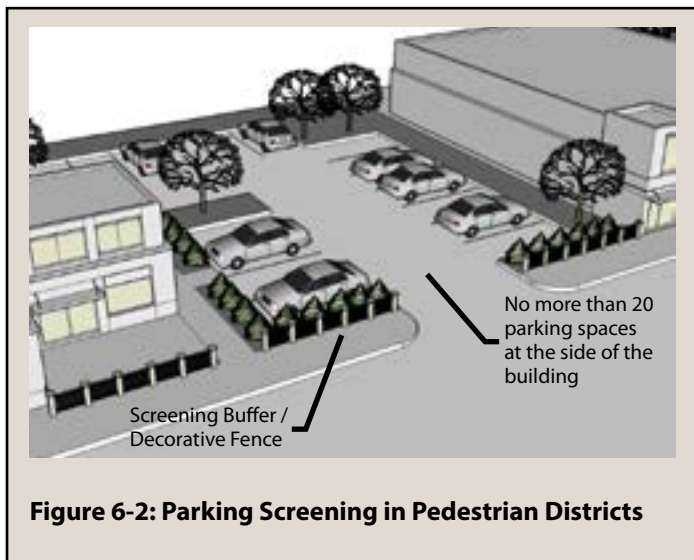

Figure 6-2: Parking Screening in Pedestrian Districts

equal to or greater than the area of parking in excess of the maximum, as public or common open space. This additional open space shall be subject to the Type, Design Standards and Location Criteria of the Civic Open Space System in Section 4.4 of the Subdivision Standards, and shall be in addition the minimum open space requirements for the site. Alternatively, the excess area may be designed as Civic Open Space, that has the capability of accommodating overflow parking at limited peak times, such as a plaza surface or stabilized green surface which can accommodate cars on limited occasions.

3. The surface of lesser used or overflow parking areas shall be a porous surface that allows all stormwater to be infiltrated below the surface, subject to the approval by the City Engineer. Any porous surface used shall demonstrate that it has at least the same or better performance standard as the required standard parking surface and does not present substantial maintenance issues.
4. Internal landscape areas for the on-site parking shall be increased by an additional 5% percent above the minimum percentage requirements of Section 6.2.8.

6.2.8 Parking Design

a. **Location, Size and Landscape Requirements.** All on-site parking shall be broken into smaller “parking blocks” and include landscape design according to the following Table 6-5. Specific zoning districts or design standards may further limit the general size and location of on-site parking spaces and parking blocks.

	<i>Front</i>	<i>Side</i>	<i>Rear</i>
250+ spaces	Must be broken into smaller parking blocks.*	Must be broken into smaller parking blocks.*	<ul style="list-style-type: none"> ▪ 5% internal landscape; AND ▪ 8’ perimeter buffer
151 to 250 spaces	<ul style="list-style-type: none"> ▪ 10% internal landscape; AND ▪ 12’ perimeter buffer 	<ul style="list-style-type: none"> ▪ 8% internal landscape; AND ▪ 10’ perimeter buffer 	<ul style="list-style-type: none"> ▪ 5% internal landscape; AND ▪ 8’ perimeter buffer
101 to 150	<ul style="list-style-type: none"> ▪ 8% internal landscape; AND ▪ 10’ perimeter buffer 	<ul style="list-style-type: none"> ▪ 5% internal landscape; AND ▪ 8’ perimeter buffer 	<ul style="list-style-type: none"> ▪ 5% internal landscape; OR ▪ 8’ perimeter buffer
31 to 100 spaces	<ul style="list-style-type: none"> ▪ 5% internal landscape; AND ▪ 8’ perimeter buffer 	<ul style="list-style-type: none"> ▪ 5% internal landscape; OR ▪ 8’ perimeter buffer 	No requirement
30 and under spaces	<ul style="list-style-type: none"> ▪ 5% internal landscape; OR ▪ 8’ perimeter buffer 	<ul style="list-style-type: none"> ▪ 5% internal landscape; OR ▪ 8’ perimeter buffer 	No requirement

* Where individual sites require or provide parking requirements larger than the maximum size, parking lots shall be broken into “parking blocks” meeting the size, location, and landscape requirements of this table.

1. **Perimeter Buffer Standards.** Perimeter landscape buffers shall be continuous around the parking block except at vehicle access points or any portion of the parking block that is bordered by buildings. The buffer shall include landscape materials meeting the requirements of Section 6.3. Where the landscape setback required by 6.3.3 is larger than the perimeter parking buffer required by Table 6-5, the greater buffer shall apply. Where perimeter landscape buffers include sidewalks meeting the internal pedestrian circulation requirements, the width of the sidewalk shall be added to the minimum required width for the perimeter buffer. Where parking blocks are located adjacent to one another, they may share the perimeter buffer along the common boundary provided it includes a pedestrian facility.

2. **Internal Landscape Standards.** Internal landscape area shall be provided as a percentage of the parking area, exclusive of drive aisles, as specified in Table 6-5. Internal landscape area shall be surrounded by raised curbs or other approved edge treatment that infiltrates stormwater, and shall include landscape materials meeting the requirements of Section 6.3. Internal landscape areas shall be allocated as end caps to parking aisles, as intermediate islands within aisles, or as buffer strips between aisles. All internal landscape areas shall be at least 8’ wide in all dimensions, and shall be no less than 150 square feet in area. Where internal landscape areas include sidewalks meeting the internal pedestrian circulation requirements, the width of the sidewalk shall be excluded from the area calculation of the internal landscape area. Internal landscape islands shall include one large canopy tree per every 150 square feet, which may contribute to the tree points required by Section 6.3.4.

3. **Limitations in the Pedestrian Districts.** In the NB, MUR, and MUB districts, the following additional design standards and limitations shall apply:

- (a) No individual on-site parking shall be located within 20’ of the front lot line unless it is located to the side of a building as provided in subsection b;
- (b) Parking may be located to the side of the building in a limited manner provided:
 - (1) the lot includes no more than 20 spaces at the side of the building;
 - (2) the lot provides no more than two rows of spaces served by a single drive aisle, and is otherwise limited in width along the streetscape to the greatest extent possible; and
 - (3) it is screened from the streetscape by a 2.5’ to 4’ decorative fence or wall matching the materials and architectural style of the building, and extended at the front building line.
- (c) Shared or public parking, or common “parking blocks” may be located along a street provided that the lot is no larger than 100 spaces, has a 8’ perimeter buffer, and is screened from the street by a 2.5’ to 4’ decorative fence or landscape screen.

ARTICLE 6

DESIGN REGULATIONS

6.2 PARKING, LOT ACCESS AND CIRCULATION

4. *Limitations in Residential Districts.* In all residential districts, where parking lots over 15 spaces are required for any use, the following additional design standards and limitations shall apply:
 - (a) The parking area shall be setback behind the front building line or at least 30' from the front lot line, whichever is greater.
 - (b) All parking areas shall have an 8' perimeter buffer used to screen the area from adjacent residential uses.
 - (c) Individual parking blocks shall be no larger than 50 spaces for any one use.

5. *Exceptions.* The Director may approve exceptions to these design and location standards for lots under 10 spaces where:
 - (a) It is reasonably necessary to accommodate infill development;
 - (b) There has been no recent investment and is no anticipated investment in the public streetscape that will be negatively impacted by the proposed alternative location and design; and
 - (c) The exception presents the least deviation from the standards necessary, and otherwise furthers the design objectives of this section.

b. Dimensional Requirements.

TABLE 6-6: PARKING STALL DIMENSIONS AND LAYOUT

Parking Angle / Width (A)	Width Parallel to Aisle (K)	Depth to Wall (C)	Depth to Interlock (E)	Aisle Width* (D)	Module** (F, G, H)		Bumper Overhang (typical) (I)
					Wall to Wall	Interlock to Interlock (G)	
45° / 9.0'	12.7'	19.5'	16.5'	12'	51'	45'	2.3'
45° / 9.5'	13.4'	19.5'	16.5'	11'	50'	44'	2.3'
60° / 9.0'	10.4'	20.5'	18.5'	16'	57'	53'	2.3'
60° / 9.5'	11.0'	20.5'	18.5'	15'	56'	52'	2.3'
75° / 9.0'	9.3'	20.0'	19.0'	23'	63'	61'	2.5'
75° / 9.5'	9.8'	20.0'	19.0'	22'	62'	60'	2.5'
90° / 9.0'***	9.0'	18.5'	18.5'	26'	63'	63'	2.5'
90° / 9.5'***	9.5'	18.5'	18.5'	25'	62'	62'	2.5'

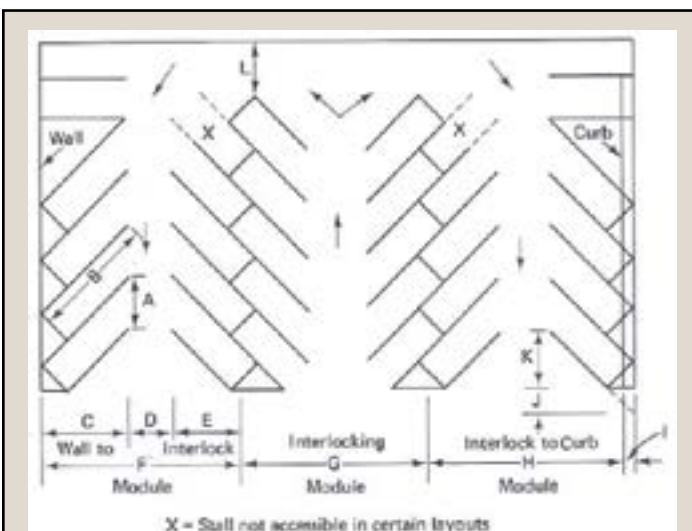

Figure 6-4: Parking Layout Dimensions for Stalls at Various Angles

- * Measured between ends of stall lines.
- ** Rounded to the nearest foot.
- *** For back-in parking, aisle width may be reduced 4.0'.

- c. **Grading and Surfacing.** All parking, circulation and loading areas shall be graded for proper drainage and be paved, unless specified otherwise in these regulations. The maximum grade shall not exceed 8%. The maximum desirable grade in any direction is 5%.

6.3 Landscape Standards

- 6.3.1 Design Objective
- 6.3.2 Applicability
- 6.3.3 Required Internal Landscape Area
- 6.3.4 Point System
- 6.3.5 Screening and Buffering
- 6.3.6 Street Trees
- 6.3.7 Landscape Material Specifications
- 6.3.8 Maintenance
- 6.3.9 Tree Reduction and Relief of Requirements
- 6.3.10 Common Landscape Plan

6.3.1 Design Objective

The Design Objective for the landscape standards is to:

- a. Enhance the environmental and ecological function of un-built portions of sites;
- b. Improve the aesthetic character of new development with natural landscape materials;
- c. Integrate common landscape and design approaches across multiple development sites, improving the character of districts and neighborhoods;
- d. Screen and mitigate visual impacts of delivery and service areas, external equipment, site utility areas or other high intensity portions of sites and developments, particularly focusing on the impact on public streetscapes and adjacent property;
- e. Reduce air, noise, and water pollution;
- f. Reduce visual harshness and summer heat gain of large expanses of blank walls and large parking areas;
- g. Improve the relationship and transitions from private development sites to public streetscapes;
- h. Provide flexibility in landscape design while promoting wise and efficient water use and viable long-term landscapes;
- i. Upgrade existing developments, governmental facilities, multifamily residential and street areas to the requirements that new development must meet.

6.3.2 Applicability

A landscape plan is required in association with a site plan, according to the application requirements in Article 2. Specifically it is required for:

- a. All new uses and buildings in any zoning district except detached dwellings, duplexes or townhouse residences;
- b. Any change of use on an existing site; or
- c. Any addition to an existing building or structure, but the requirements of this section shall be pro-rated to that

portion of the site affecting development.

- d. In areas of subdivisions and development sites where landscaping is not required or not anticipated by the department, the developer shall reclaim all disturbed property and replant the entire area with native vegetation. Topsoil shall be stockpiled and placed on disturbed areas. Irrigation shall be provided to the revegetated areas if it is necessary to ensure survival of native species planted. The grading plan shall include a section outlining the type and extent of revegetation proposed to accomplish this requirement.

6.3.3 Required Internal Landscape Area

The Required Internal Landscape Area for the purposes of determining landscape material requirements shall be based on the lot coverage standards in each zoning district. Required landscape materials shall be based on a point system established in this section multiplied by the remainder of the lot area outside of the lot coverage allowances. Required landscape materials shall be planted within the following areas and distributed evenly throughout the site.

- a. **Landscape Setback.** Except where street-front buildings are permitted or required by operation of the zoning district standards, all sites shall have a Landscape Setback beyond the right-of-way at the lot line meeting the following:

TABLE 6-7: REQUIRED LANDSCAPE SETBACK	
Adjacency*	Setback Depth
Arterial Street	15'
Collector Street	10'
Local Street	6'

* Based on current master transportation plan.

No parking or other structures shall be allowed within the landscape setback areas. Corner lots, double frontage lots and triple frontage lots shall have landscape setbacks along each right-of-way.

- b. **Parking Landscape Areas.** The parking landscape area shall consist of internal landscape areas and perimeter buffers as required by Section 6.2.
- c. **Required Open Space.** The required open space shall consist of any Civic Open Space required by Section 4.4, Section 6.6, Section 6.7, or Section 6.8, when applicable.
- d. **Other Open Areas.** Foundation planting areas adjacent to building elevations which form the major public views of the building from adjacent streets and properties, screening and buffering areas required by this section, and other un-built portions of the site shall also be used for allocation of required landscape materials.

6.3.4 Point System

The required landscape material within the Landscape Setback Area, Parking Landscape Area, and Required Open Space shall be based on a point system established below. All points shall be distributed evenly across the site.

- a. **Trees.** The sum of all Tree points, as defined in Table 6-8 below, from trees used in the landscape must exceed the required landscape area divided by 500. For the purpose of calculating the Tree Point requirement, utility easements within internal landscape areas, athletic fields, and playgrounds may be subtracted from the required internal landscape area.

Tree types	Size or Quantity	Point Value
Existing mature tree approved by City Forestry.	1	1.5 - 3
New 1.5" caliper deciduous tree (single trunk or clump) with a mature height of 30' or greater and a mature canopy of 30' or greater.	1	1.5
New 1.5" caliper ornamental tree with a mature height less than 30' and a mature canopy less than 30'.	1	1
New 6' evergreen tree with a mature height of 30' or greater and mature spread of 20' or greater.	1	1.5
New 4' evergreen tree with a mature height less than 30' and a mature spread less than 20'.	1	1

- b. **Ground Cover and Non-tree Landscape Features.** The sum of all Ground Cover and Non-tree Landscape Feature points, as defined in Table 6-9 below, from ground cover and non-tree landscaping features used in the landscape must exceed the square footage of the required internal landscape area divided by 500.

Landscape Feature	Size or Quantity	Point Value
Shrubs		
Existing or new evergreen or deciduous shrubs.	1	0.25
Ground Covers		
Functional turf grass	500 sq. ft.	0.15
Non-functional turf grass	500 sq. ft.	0
Seeded, native, short-grass prairie species or mixes requiring less than ½ inch of supplemental watering per week during hot, dry periods.	500 sq. ft.	0.5
Ornamental grass or perennials.	1	.15
Other Landscape Elements		
Large deciduous and evergreen trees in addition to the required internal tree points and street trees	1	1.5
Small deciduous and evergreen trees in addition to the required internal tree points and street trees	1	1
Large Boulders (landscape plan to include specification for size and type)	1	.25
Gazebo or outdoor structure	100 sq. ft.	1
Picnic Tables	1	.5
Benches	1	.5
Art—As approved by the Art in Public Places Committee or City Council.	1	up to 4*
Gardening space for residents or development users—Includes signage, fencing, water access and maintenance agreement.	100 sq. ft.	1
Athletic field, grass or artificial (separate from functional turf grass points)	500 sq. ft.	1
Hardscaped athletic area or aesthetic plaza.	500 sq. ft.	1
Playground with ADA approved surface.	500 sq. ft.	1
Path or trail with ADA approved surface.	500 sq. ft.	1
Other—As approved by the Director.		varies

*In no case more than half the required ground cover points.

6.3.5 Screening and Buffering

a. **Required Buffer Level.** The required screening and buffering levels, shown in Table 6-10 below, apply to common property lines and alleys. Screening and buffering requirements do not apply between zone districts not listed in the table.

		<i>Lowest District to Highest District</i>																	
		LR	NR-1	NR-2	NR-3	MR	HR	MUR	MUB	NB	MUE	SS	CB	CBD	P	BP	LI	HI	
Highest District to Lowest District	HI	3	3	3	3	3	3	2	2	2	2	2	2	2	2	1			
	LI	2	2	2	2	2	2	2	2	C		2	2	2	1				
	BP	2	2	2	2	2	1	1							1			1	
	P	2	2	2	2	2	2	2	1	1	1	1	1			1	1	2	
	CBD	2				2												2	2
	CB	2	2	2	2	2	1	1	1	1	1				1		2	2	
	SS	2	2	2	2	2	1	1							1		2	2	
	MUE	2	1			1								1	1			2	
	NB	2				1								1	1		2	2	
	MUB	2				1								1	1		2	2	
	MUR											1	1		2	1	2	2	
	HR	1									1	1	1		2	1	2	3	
	MR								1	1	1	2	2	2	2	2	2	3	
	NR-3											2	2		2	2	2	3	
	NR-2											2	2		2	2	2	3	
	NR-1										1	2	2		2	2	2	3	
LR						1		2	2	2	2	2	2	2	2	2	3		

b. **Design of Buffer Levels.** The buffer levels shall be designed according to the standards in Table 6-11.

	Level 1	Level 2	Level 3
Intent and Use	Intended to provide a visual break and soft transitions between different sites, and to blend different sites more seamlessly.	Intended to provide visual break and minimize potential visual impacts on adjacent sites.	Intended to separate potentially incompatible sites and uses and to minimize any visual, physical, or noise impacts on adjacent sites.
Landscape Width	10'	15'	25'
Plant Materials	<ul style="list-style-type: none"> • 1 deciduous shade or six-foot evergreen tree for each 50 linear feet of buffer or 2 ornamental trees for each 50 linear feet of buffer; plus • 1 shrub for each 10 linear feet of buffer 	<ul style="list-style-type: none"> • 2 deciduous shade or six-foot evergreen trees for each 50 linear feet of buffer or 1 deciduous shade or six-foot evergreen tree and 2 ornamental trees for each 50 linear feet of buffer; plus • 3 shrubs for every 10 linear feet of buffer 	<ul style="list-style-type: none"> • 3 deciduous shade or six-foot evergreen trees for each 50 linear feet of buffer or 2 deciduous shade or six-foot evergreen trees and 2 ornamental trees for each 50 linear feet of buffer; plus • 3 shrubs for every 10 linear feet of buffer
Screen	n/a	n/a	<ul style="list-style-type: none"> • A six-foot-high solid fence with required plant material located to the outside; or • 1 six-foot evergreen tree for every 10 linear feet of buffer.
Ground Cover	All remaining areas of the buffer shall be planted with ground cover meeting any of the standards in Table 6-9		

c. **General Design Requirements.**

1. Plant materials in the buffer may satisfy the landscape requirements of Section 6.3.4, but where the buffer would require more plants than otherwise required in Section 6.3.4, the greater requirement shall apply.
2. Parking shall not be permitted in the required buffer, however the required buffer and a parking lot perimeter buffer required by Section 6.2. may overlap with the more stringent of the two standards controlling.
3. Trash collection areas and trash bins shall not be allowed within screening and buffering areas.
4. There shall be no storage of merchandise and supplies within screening and buffering areas.

d. **Location.** Screening and buffering shall be met within the property lines of the higher intense use except:

1. All property within the P District shall provide the required screening and buffering unless it is adjacent to the LI or HI district.
2. If a property is developed with the abutting property having the same zoning district and the owner of the abutting property upzones the abutting property, then that property owner shall provide and install all screening and buffering items.
3. All property within zoned districts AR, AG, or RR shall be treated as if those zoning districts were zoned MR for the requirements of screening and buffering.

e. **Exception.** The Director may approve site designs with alternative compliance to the buffer and transition standards where all of the following are met:

1. The proposed use exhibits exemplary site design that meets the intent and design objectives of all design elements in Article 6.
2. Due to the layout and orientation of the site, no other incompatibility of site design elements exists between the site and what could be built on adjacent sites according to existing regulations.
3. The deviation is the minimum needed for effective site design or is otherwise mitigated by enhanced site elements. For example, to allow effective infill development in urban situations, the width of the buffer may be lessened in exchange for enhanced landscape screens, ornamental walls or other designs that are suitable for an urban context and still meet the design objectives of this section.

6.3.6 Street Trees

In addition to the point system planting requirements in Section 6.3.4, all sites shall include street trees according to this section. However, any zoning district that allows Street-front buildings within 0' to 10' of the lot frontage may count street trees towards the point system requirement.

- a. Trees are required adjacent to arterials, collectors and local streets subject to City Forestry's standards for street trees and the Street Design Standards of Section 4.3.
- b. The projected mature size of a specific tree species will help determine the spacing distance between trees. Trees will be spaced to allow them to reach their full, healthy potential.
- c. As determined by species, the minimum spacing will be 15', and the maximum spacing will be 40'. The City Forester will determine the proper spacing.
- d. Trees may be clustered along a particular frontage, and otherwise located to avoid conflicts with utilities and easements, according to Appendix G, Streetscape Design, Planning, and Maintenance Guidelines. In no case may the spacing exceed forty 40'.
- e. Street trees shall be located in the adjacent public right-of-way unless site development does not allow street trees in the right-of-way. If street trees are placed in the landscaped setback area, the landscaped setback required depth shall be 5' greater than the minimum required depth. However, in any case, the required trees shall be located within 25' of the property line adjacent to a street.

6.3.7 Landscape Material Specifications

- a. **Installation Timing.** All landscaping shall be installed prior to the issuance of a certificate of occupancy, however an exception may be granted by the Director to install the landscape at a later date. To obtain a certificate of occupancy without installed landscaping, future landscape installation shall be secured with an acceptable form of surety for 125% of the value of the landscape, prior to the issuance of a certificate of occupancy. An acceptable form of surety may include an irrevocable letter of credit, bond or cash.
- b. **General Planting Specifications.**
 1. Plant selections should be those known to be able to survive in Cheyenne and Laramie County. Questions about suitability should be directed to the City Forester.
 2. Landscaping shall be installed according to sound

horticultural practices in a manner designed to encourage quick establishment and healthy growth.

3. Tree quality shall meet the most current available American Standard for Nursery Stock (ANSI Z60.1) specifications.
4. Plant spacing should allow for the growth characteristics of the trees without adversely affecting the expected mature size of nearby trees or the function or maintenance of structures, walks, drives or parking.
5. Tree species selection should reflect species historically found in the neighborhood.
6. Soil improvement is required in all soils upon which lawn or turf will be installed. The top six inches of soil, including amendments uniformly worked through the soil, shall have an organic matter percentage greater than 3% and salinity less than 1.0 milliohms per centimeter.
7. Landscaping shall not conflict with traffic visibility requirements in Article 4 of this Title.
8. Clumps of trees (such as aspen, populus tremuloides), where used, shall be credited as only one of the required trees.
9. Landscaping should not interfere with the general function and safety of any gas, electric, water, sewer, telephone or other utility easement. Landscaping shall be limited to an eight-inch mature height within 5' of a fire hydrant.
10. Healthy existing indigenous vegetation on a site may be credited toward required landscaping in this Article.
11. Where two different landscape requirements apply by any section of this code, the greater requirement shall be met.

- c. **Size Specifications.** Minimum planting/installation size and characteristics of plant material shall be as follows:

Plant Type	Minimum Size Specification
<i>Deciduous shade trees</i>	1.5" caliper measured 6" above ground
<i>Deciduous ornamental trees</i>	1.5" caliper measured 6" above ground
<i>Evergreen trees</i>	4' or 6' high measured from the ground to the midpoint between the uppermost whorl and the tip of the leader
<i>Evergreen and deciduous shrubs</i>	five-gallon container
Ornamental grass or perennials	2.25" container

- d. **Tree Species Diversity.** To prevent uniform insect or disease susceptibility and eventual uniform senescence on a development site or in the adjacent area or the district, species diversity is required and extensive monocultures are prohibited. In limited areas the City Forester may approve deviations from the minimum requirements to reflect species historically found in the neighborhood. The following minimum requirements shall apply to any development plan:

Number of Trees On Site	Maximum Percentage of Any One Species
10—19	50%
20—39	33%
40—59	25%
60 or more	15%

- e. **Percentage of living materials.** Unless otherwise specified, any required landscape area, including the internal landscaping area, screening and buffering areas, landscaped setback and parking strips, shall consist of a minimum 75% ground cover by living grass or other plant materials based on mature size of vegetation.
1. The foliage crown of deciduous trees shall not be used in the 75% or other required percentage calculations.
 2. The remaining 25% of the required landscape area may be covered with bark, wood chips, rock, stone or similar materials. Bark, wood chips, rock, stone or similar materials may be used as an initial ground cover until vegetation matures.
 3. Artificial trees, shrubs, vines, turf or other artificial plants shall not be considered as outside landscape materials, except for turf used in athletic fields.
- f. **Irrigation systems.** An automatic irrigation system shall be provided to regularly irrigate all living plants within all landscape areas according to the plant's water needs.
1. Automatic irrigation system design shall include the following:
 - (a) An electronic automatic controller with battery backup and adjustable calendar capabilities.
 - (b) Each valve shall irrigate a landscaped area with similar site, slope, soil conditions and watering needs of plants. Turf and nonturf areas shall be irrigated on separate valves. Drip and broadcast irrigation shall be on separate valves.

2. *Exception:* Areas landscaped with short-grass prairie that abut land protected by the City of Cheyenne or Laramie County for the purpose of maintaining natural resources, nature-oriented recreation or scenic areas may be excepted from requiring an irrigation system.
3. *Exception:* Locations utilizing existing landscape may be excepted from requiring an automatic irrigation system.
4. *Exception:* Areas, including those in the public right-of-way, landscaped with seeded drought tolerant grass ground covers in all zoning districts may be excepted from requiring an automatic irrigation system. An automatic drip irrigation system shall be provided to regularly irrigate all other required landscaping including trees, shrubs, ornamental grasses and perennials according to their watering requirements. Non-irrigated areas landscaped with drought tolerant grass ground covers shall be seeded according to G-8 Turf Seeding Standards (except for D.5 Watering), G-9 Fine Grading and Soil Preparation Standards, G-10 Streetscape Maintenance Standards and G-11 Establishment Maintenance for Newly Planted Trees.

6.3.8 Maintenance

- a. All landscape elements shall be considered as elements of the project in the same manner as parking, building materials and other site details. The applicant, landowner or successors in interest shall be jointly and severally responsible for the regular and normal maintenance of all landscaping elements in good condition as originally approved. All landscaping shall be maintained free from disease, pests, weeds and litter, and all landscape structures such as fences and walls shall be repaired and replaced periodically to maintain a structurally sound condition.
- b. Plant materials which exhibit evidence of insects, pests, disease and/or damage shall be appropriately treated and all dead plant materials shall be removed and replaced with living plant material. Trees, shrubs and other plant materials (including grasses) which expire during their growing season, shall be replaced within 30 days. Trees, shrubs and other plant materials (including grasses) which expire during their dormant season shall be replaced by July 1st of each year.
- c. Performance Standard for Seeded Areas. Seeded landscape areas shall have no bare areas larger than one

square foot after germination. Ground cover that dies within the growing season must be replaced within 30 days. Ground cover that dies after the growing season shall be replaced by the following June 1st.

6.3.9 Tree Reduction and Relief of Requirements

- a. A 10% reduction of the required number of internal and/or street trees, for a property requiring a site plan, may be granted by the Director based on specific site conditions and to best meet the Design Objectives of this Section.
- b. If a tree reduction is approved:
 1. A per tree monetary donation shall be made by the applicant to the City, for every tree reduced, to be deposited in a specific fund for use in purchasing trees for the Greater Cheyenne Greenway, and other City lands, including but not limited to, open spaces, park areas and right(s)-of-way.
 2. The City Forester shall determine the monetary donation per tree yearly on January 1st of each year, based on the average wholesale cost of trees from three regional wholesale nurseries. This fee shall be in effect for the calendar year and be available to the public at the Development Office.
 3. Per tree monetary reductions can count toward the point system as a new, non-adapted tree.
- c. If planting trees obstructs wall signs, up to one-half of the required trees that obstruct wall signs, may be substituted by shrubs. 25 shrubs with a minimum container size of five gallons shall be provided for each tree that is replaced.

6.3.10 Common Landscape Plan

As an alternative to individual site landscaping, developments of eighty (80) acres or larger in Light Industrial (LI) and Heavy Industrial (HI) zoning districts may submit a Common landscape plan that would contribute to uniformity of a Development Area's collective appearance. Common landscape plans shall focus on providing landscaping that is beneficial to the public, consistent with the general landscape character and context of the area, creative urban design, and water conservation. Common landscape plans shall be administratively approved by the Director.

- a. **Submittal Requirements.** Applications for a common landscape plan may be initiated by all property owner(s) of

all property subject to the common landscape plan, or an agent or entity authorized by all property owner(s) through mutual agreement or a property owner's association.

b. **Application, Submittal, and Phasing.** An applicant shall submit a conceptual common landscape plan, prepared by a licensed landscape architect, for the entire development based on Table 6-13.1 for the plan area and a project narrative detailing the landscape plan approach and proposed uses within the development. Installation of landscaping may be developed in phases and the developer shall submit phasing plan in conjunction with submittal of common landscape plan. Phasing plans shall show general locations of landscaping, materials, plantings, groundcover, anticipated development footprints, and any transferred points within the plan area. As development occurs on lots within the development area, site / landscape plans shall be submitted and reviewed by the City to determine that each site meets the intent of the common landscape plan.

c. **Common Landscape Plan Standards.** The landscape standards of Chapter 6.3 of the UDC shall apply, except as set forth below.

1. **Required Internal Landscape Area.** The Required Internal Landscape Area of Section 6.3.3 shall be ten (10) percent of the development footprint calculated pursuant to Table 6-13.1. Required internal landscaping may be transferred to other areas within the area subject to the plan. Required internal landscape is encouraged to be placed in the most highly visible and used areas in the development, such as at critical intersections, along streets and highways, entry monumentation, parking areas, building entrances, employee gathering areas, sites heavily-trafficked by the general public, and Service, Employment, and Commercial Use development sites within the plan boundary.

2. **Street Trees and Tree Boulevards.** The Street Tree standards of 6.3.6 shall be adjacent to arterials, collectors, local streets, and interstates subject to City Forestry's standards for street trees and the Street Design Standards of Section 4.3, at the rate of one tree per sixty (60) feet of street frontage. Street trees may be proposed in the adjacent public right-of-way or within one hundred (100) feet of the property line adjacent to a street right-of-way. In the event an easement restricting the planting of trees exists within the boulevard area, the distance may be increased

in an amount equal to the width of the easement. Street trees may be substituted with large growing evergreen trees provided they do not interfere with necessary sight distance requirements. Street trees are encouraged to be clustered at or near intersections, rather than evenly spaced.

3. **Development Footprint Basis.** The Development Footprint shall be calculated based on the area of each individual lot in the development, as shown in Table 6-13.1 below. Development Footprints may be adjusted based on site constraints, such as topography, easements, Natural/Cultural Resource Areas identified in PlanCheyenne, or similar, that precludes developing portions of constructed lots. A determination of land area adjustments shall be at the discretion of the Director.

Size	Lot Coverage Basis
Less than 5 acres:	90% of Lot Area
5 acres to less than 10 acres:	75% of Lot Area
10 acres to less than 25 acres:	60% of Lot Area
Greater than 25 acres:	50% of Lot Area

- d. **Tree Reduction and Relief of Requirements Allowance.**
- Up to a twenty-five (25) percent reduction of the required number of internal and/or street trees may be granted by the Director based on specific site conditions and to best meet the development's collective appearance. If a tree reduction is approved: A per tree monetary donation shall be made by the applicant to the City, for every tree reduced, to be deposited in a specific fund for use in purchasing and installing trees for the Greater Cheyenne Greenway and other City lands, including but not limited to, open spaces, park areas and rights-of-way.
 - The City Forester shall determine the monetary donation per tree yearly on January 1st of each year, based on the average wholesale and installation cost of trees from three regional landscape contractors. This fee shall be in effect for the calendar year and be available to the public.
 - A per tree monetary reduction can count toward the point system as a new tree.
- e. **Substitutions for Required Trees.** Up to twenty-five (25) percent of required trees (street and internal trees) may be substituted at the quantities and rates below:

TABLE 6-13.2: TREE SUBSTITUTION EQUIVALENT

<i>Substitute Item</i>	<i>Rate</i>	<i>Quantity Required to Replace Single Tree</i>
Large Shrub > 10' height at maturity	Per plant	2
Medium Shrub 4' – 10' height at maturity	Per plant	4
Small Shrub < 4' height at maturity	Per plant	8
Ornamental Grasses & Perennials	Per ornamental grasses or perennials	10
Wayfinding Sign(s)	Per 40 sq. ft. combined face area	1
Monument Sign Identifying Development	Per 100 sq. ft. face area.	1
Decorative Fence	Per 200 lineal feet	1
Specimen landscape boulders > ½ ton each	Per ½ ton	1
Others (e.g.: Art, gateway features, etc.).	Determined by the Director based on financial investment	

- f. **Tree Species Diversity.** As an alternative to UDC 6.3.7.d, Tree Species Diversity, developments utilizing a common landscape plan may incorporate the following:
 1. A minimum of two deciduous species from different genera with each genus not to exceed thirty (30) percent of the total tree count of the area covered by the plan, and
 2. A minimum of two evergreen species from different genera not to exceed thirty (30) percent of the total tree count of the area covered by the plan.

- g. **Review Criteria.** In reviewing, providing comments, and making decisions on a proposed common landscape plan, the Director shall use the following criteria:
 1. The proposed alternative design achieves the intent of the subject design standard to the same or better degree than the subject standard; achieves the goals and policies of PlanCheyenne to the same or better degree than the subject standard; and results in benefits to the community that are equivalent to or better than compliance with the subject standard; or
 2. The required landscaping on each lot is not practical because of location, topographic, or site constraints while the alternative design can accommodate site-specific issues.
 3. The plan represents a logical phasing plan for the development.
 4. Adequate utilities exist to serve the landscape elements detailed in the plan.
 5. The plan shall not place an undue fiscal burden on the City or other public entities.
 6. An entity has been identified for maintenance of common landscape plan elements and any necessary agreements can be executed within sixty (60) days of approval.
 7. Incorporates an area of at least eighty (80) acres. For the purposes of area calculation, intervening rights-of-way shall be included in the measurement.

- 8. The plan is prepared by a licensed landscape architect.

- h. **Amendments and Alterations.** Amendments to the common landscape plan may only be initiated with the consent of all property owner(s) of all property subject to the common landscape plan or an agent or entity authorized by all property owner(s) through mutual agreement or a property owners' association.

- i. **Recording and Approval.** Following approval of a Common Landscape Plan, the Director shall sign the plan and the applicant shall then record the plan on each affected lot or parcel in the office of the County Clerk and be responsible for any associated fees. The applicant shall provide a copy of the recorded plan to the Director prior to issuance of any building permits.

- j. **Abandonment of Plan.** In the event the applicant wishes to abandon the approved Common Landscape Plan, the Director must determine that abandonment of the plan is not detrimental to the plan area and that the applicant has taken reasonable and necessary steps to mitigate any non-conforming site conditions on existing sites in the plan area. Requests for abandonment may be initiated by the Governing Body, the Director, by all property owner(s) of all property subject to the common landscape plan, or an agent or entity authorized by all property owner(s) through mutual agreement or a property owner's association. Upon Director determination that abandonment is acceptable, the Director shall sign any necessary releases to be filed with the office of the County Clerk."

6.4 External Lighting

- 6.4.1 Design Objective
- 6.4.2 Applicability
- 6.4.3 Lighting Design

6.4.1 Design Objective

The Design Objective for the external lighting requirements is to:

- a. Protect night skies and surrounding neighborhoods from light pollution and light trespass.
- b. Emphasize pedestrian environments using fixtures designed to a pedestrian scale.
- c. Allow for creative use of lighting to highlight pedestrian, building design and landscape amenities.
- d. Encourage energy conservation.
- e. Encourage a safe and productive environment.

6.4.2 Applicability

A lighting plan is required in association with a site plan, according to the application requirements in Article 2. Specifically it is required for:

- a. All new uses and buildings in any zoning district except detached dwellings, duplexes or townhouse residences;
- b. Any change of use on an existing site that involves alteration of existing exterior lighting. Alterations replacing more the 50% of existing exterior lighting fixtures shall require full compliance with all standards in this Section; or
- c. Any new proposed exterior lighting.

6.4.3 Lighting Design

- a. Unshielded fixtures are not permitted;
- b. Lighting shall be provided at internal sidewalks or pathways, common areas or facilities, primary entrances and in parking areas. Pedestrian scale lighting can be integrated into bollards, wall/ seat walls, building, and pavement;
- c. Freestanding fixtures shall not exceed 20' high within 50' of any residential zoning district. In all other locations, freestanding fixtures shall not exceed 30' or the height of the principal building, whichever is less. Measurements shall be taken from the grade at the base of the fixture to the top of the light fixture;
- d. Building mounted light fixtures shall not be attached to a roof and in no instance shall the light fixture be mounted

- at a height exceeding 30' above grade as measured at the nearest base floor elevation;
- e. All lights shall be directed downward and the light source shielded so it is not visible from adjacent properties, except for accent and flagpole lighting, which shall be permitted to be directed upward as long as the light source is shielded and not visible from any adjacent property. Light fixtures used to illuminate flags, statues or any other objects mounted on a pole, pedestal or platform shall use a narrow cone beam of light that will not extend beyond the illuminated object;
- f. Fixtures installed under canopies, awnings and overhangs shall be fully recessed;
- g. Lighting schemes highlighting pedestrian, landscape or building design amenities or features may be considered by the Director on a case by case basis provided the proposed design meets the intent of the ordinance.

6.5 Signs

- 6.5.1 Design Objective
- 6.5.2 Applicability
- 6.5.3 Sign Types
- 6.5.4 Sign Allowances
- 6.5.5 Sign Plans and Permits
- 6.5.6 Compliance and Maintenance
- 6.5.7 Prohibited Signs
- 6.5.8 Billboards

6.5.1 Design Objective

The Design Objective for the sign requirements is to:

- a. Maintain and enhance the visual quality (aesthetics) of the community.
- b. Protect and enhance economic viability by providing the ability to communicate and attract economic growth while ensuring the City will be a visually pleasant place to visit or live.
- c. Provide effective and efficient means of communication and identification for businesses by limiting sign clutter.
- d. Protect property values and private and public investments by minimizing adverse effects of signs on property.
- e. Promote pedestrian and vehicle safety by balancing the need for adequate wayfinding with minimizing distractions or obstructions from views for travelers within streetscapes.
- f. Protect views of the natural landscape and sky.

6.5.2 Applicability

A sign plan is required in association with a site plan, according to the application requirements in Article 2. Specifically it is required for:

- a. All new uses and buildings in any zoning district except detached dwellings, duplexes or townhouse residences;
- b. Any change of use on an existing site that involves alteration of an existing sign. Alterations of existing signs that replace more than 50% of the surface area of the existing sign shall require full compliance with all standards in this Section; or
- c. Any new proposed sign, unless exempt from the sign permit process in this Section.

6.5.3 Sign Types

The following sign types are distinguished for the purposes of the sign requirements in this Section. They are distinguished by category and specific type. Where the standards refer to a category, it shall include all types within that category unless the context and specific application of the standard indicates otherwise. When the standards refer to a specific type, it shall include only that specific type unless the context and specific application of the standard indicates otherwise.

TABLE 6-14: SIGN TYPES

Building Sign	Any sign associated with and attached to a building or portion of a building and aimed at communicating messages to vehicles in the roadway or pedestrians at a distance from the building.	
	Wall sign	A sign painted, printed or attached to the exterior surface of a building, and flat or no more than 12" off the exterior surface.
	Projecting Sign	A sign projecting from the exterior surface of a building and extending more than 12" from the surface.
Ground Sign	Any sign that is mounted to the ground independent from any building	
	Low-profile Sign	A sign built into or placed upon the ground by way of an ornamental structure that is not part of a building, and where the surface area of the structure does not exceed 50% of the sign area of the sign mounted upon it.
	Freestanding Sign	A sign placed upon a pole or support that elevates the sign above the ground level by more than 6'.
	Incidental Sign / Directional Sign	A ground sign that does not exceed 6 square feet providing directions or instructions that improve the function and use of the site.
Pedestrian Sign	Any building sign aimed at communicating directly with pedestrians in front of or immediately adjacent to the building.	
	Awning Sign / Canopy sign	A sign painted, printed, or attached on an awning or canopy, and attached flat against the surface of the awning and oriented to the pedestrian flow at the first story along the building frontage.
	Hanging Sign	A sign under and mounted to a canopy or awning, mounted on a wall, or projecting from a wall no more than 4' and oriented to pedestrians at the first story along the building frontage.
	Window Sign	A sign hanging in or painted on a building window.
Temporary Sign	Any sign intended to be used for a limited duration associated with an event or distinct time period and which is easily placed and removed from the ground or building without needing additional structures, construction or specialized equipment.	
Neighborhood Identification Sign	Any monument sign identifying a distinct residential neighborhood or complex.	

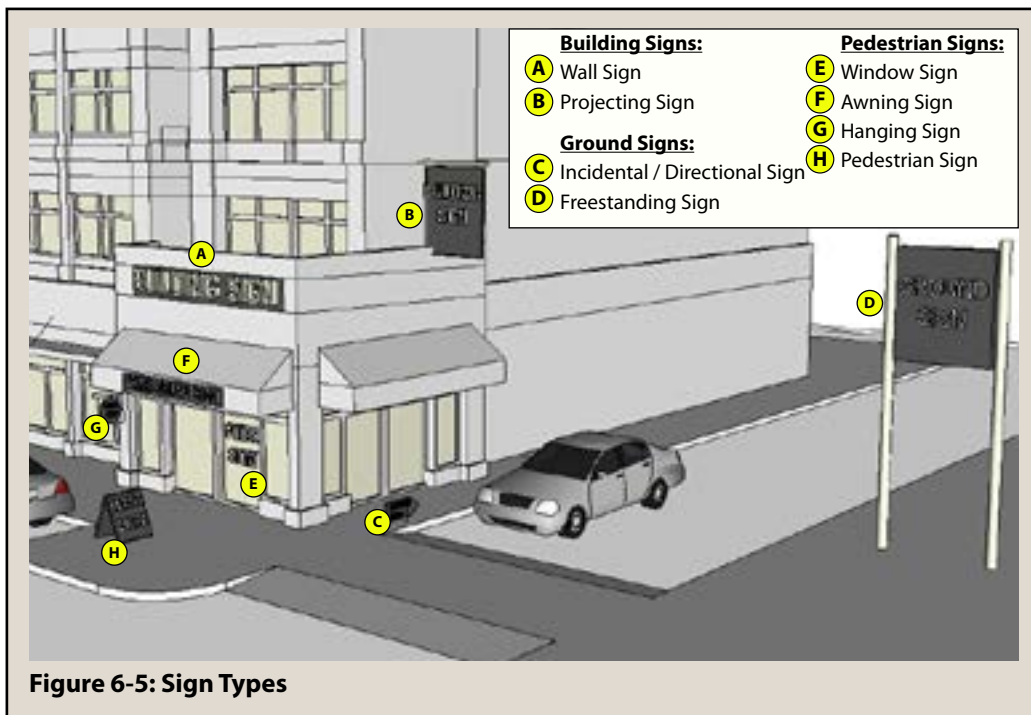

6.5.4 Sign Allowances

The following sign allowances apply to zoning districts or groups of zoning districts as the basic standard. Other restrictions in this Section, or other regulations may operate to further reduce the basic sign allowances within each zoning district.

- a. **Rural and Agriculture and Residential Zoning Districts.** The allowances in Table 6-15 apply to the AG, AR, RR, LR, MR, NR-1, NR-2, NR-3, and HR districts.

TABLE 6-15: RESIDENTIAL DISTRICT SIGN ALLOWANCES	
Temporary Signs	<ul style="list-style-type: none"> ▪ Up to 2 per lot ▪ No single sign shall be more than 6 square feet ▪ Lots larger than 1 acre, or with more than 150' of street frontage may have up to 4 signs, and may exceed the area requirements provided the total area of all temporary signs does not exceed 24 square feet, and no more than 16 square feet per single sign. ▪ Signs may be placed up to 10 days prior to and following the event or distinct time period addressed by the sign.
Neighborhood / District Identification Signs	<ul style="list-style-type: none"> ▪ Up to 2 per each street intersection with an arterial street and no more than 32 square feet for each sign. The area allowance for each arterial intersection may be allocated to more frequent signs at smaller intersections within the neighborhood. ▪ No sign or structure supporting the sign shall exceed a height of 6'.
Other Signs	<p>1 Building Sign, Ground Sign, or Pedestrian Sign is allowed for each street frontage where any non-residential use is approved as a permitted, administrative, or conditional use within the zoning district. These other signs shall be limited as follows:</p> <ul style="list-style-type: none"> ▪ No more than 8 square feet and a height of 8' for residential dwelling building types. ▪ No more than 48 square feet and a height of 8' for non-residential or mixed-use building types. ▪ Any ground sign shall be setback at least 5' from the property line. ▪ No more than 3 square feet and a height of 8' for home occupations.

- b. **Mixed-Use, Commercial and Industrial Zoning Districts.** The allowances in Table 6-16 apply to the NB, CB, CBD, MUR, MUB, MUE, LI, HI, AD, P, SS, BP, and PUD districts.

TABLE 6-16: NON-RESIDENTIAL DISTRICT SIGN ALLOWANCES	
Temporary Signs	<ul style="list-style-type: none"> ▪ Up to 2 per lot ▪ No single sign shall be more than 32 square feet. ▪ Signs may be placed up to 45 days prior to and 10 days following the event or distinct time period addressed by the sign.
Building Signs	<ul style="list-style-type: none"> ▪ Wall Signs up to 20% of the wall area, but no more than 400 square feet total. The NB, MUR , and MUB districts shall count only 10% of the street facing walls up to the height of 20' in calculating the Wall Sign allowance. Only one Wall Sign per each 50' of building frontage is permitted in the CBD. ▪ 1 Projecting Sign per street frontage, projecting no more than 5' from the surface, and no greater than 32' in area. Projecting Signs shall have a clearance of at least 10', and shall project no higher than the highest point of the building.
Ground Signs	<ul style="list-style-type: none"> ▪ 1 Freestanding or Low-profile Sign per street frontage or building complex. The height and area of Freestanding Ground Signs shall be based on Table 6-17. The area shall be limited to 8 square feet for each 25' of lot frontage up to a maximum of 80 square feet. ▪ Incidental signs may be provided at 12 square feet per acre, and no more than 6 square feet per sign.
Pedestrian Signs	<ul style="list-style-type: none"> ▪ Awning Signs / Canopy Signs provided the awning or canopy provides at least 8' clearance and the sign is limited to 3 square feet per linear foot of awning or canopy. ▪ Hanging Signs shall be allowed one per every 50 linear feet of building frontage, or one for every building entrance, whichever is greater. Hanging Signs shall not exceed 12 square feet in area. ▪ Window Signs shall be allowed in any street-level window. Window signs shall not exceed more than 25% of the window area between 2' and 8' above grade.
Neighborhood / District Identification Signs	<ul style="list-style-type: none"> ▪ Up to 2 per each street intersection with an arterial street and no more than 32 square feet for each sign. In industrial business parks in the MUE, BP, and HI zone districts, the allowance for neighborhood identification signs may be up to 200 square feet per sign. The area allowance for each arterial intersection may be allocated to more frequent signs at smaller intersections within the neighborhood. ▪ No sign or structure supporting the sign shall exceed a height of 6'. In industrial business parks in the MUE, BP, and HI zone districts, sign structures may be up to 20' high, and neighborhood identification signs may be placed on prominent structures having a non-sign primary function (such as a water tower, cell tower, electrical facility, or similar).

1. *Ground Sign Limits.* Any allowed ground sign in a non-residential zoning district shall be limited according to the following table:

Distance From Right-of-way	Freestanding Height	Freestanding Area	Low-profile Height	Low-profile Area
0' – 5'**	10'	20 s.f.	8'	40 s.f.
5' – 10'**	12'	30 s.f.	8'	60 s.f.
10' – 15'**	14'	40 s.f.	10'	70 s.f.
15' – 20'	16'	50 s.f.	12'	80 s.f.
20' – 25'	18'	60 s.f.	12'	90 s.f. *
25'+	20'	70 s.f.	12'	100 s.f. *

* In the CBD District, low profile ground signs shall not exceed 80 square feet, and shall not exceed 20' in height or the height of the building associated with the sign, whichever is less.

** In the CB, CBD, and AD Districts, freestanding ground signs shall be set back at least 15' from the street right-of-way.

*** Freestanding signs are not allowed in the NB, MUB, or MUR Districts.

2. *Additional Regulations and Distinctions.* The following additional regulations and distinctions apply to signs in the non-residential zoning districts:

- (a) Drive-through signs, where permitted are limited by drive through design and location standards and in no case may exceed more than 32 square feet. Any directional signs associated with the drive through shall be limited by the Incidental / Directional Sign allowances for the site.
- (b) Ground Signs shall be setback at least 15' from any side lot line.
- (c) Not more than one externally illuminated sign shall be allowed per street frontage.
- (d) Illuminated signs and awnings are allowed only with reverse copy with no white or ivory background.
- (e) Sign cabinets shall be finished. Aluminum sign cabinets shall be painted or anodized and shall not be mill finished aluminum. Electrical conduit shall not be routed along the outside of walls to a sign, but shall be routed through the wall at the sign location.
- (f) Indirect lighting shall be shielded so as not to create glare to vehicle or pedestrian traffic.
- (g) Ground Signs shall not exceed 8' in height and 48 square feet in area in the MUR district, and Wall Signs shall not exceed 48 square feet in area in the MUR district.

3. *Incentives / Bonus.*

- (a) *Materials.* A 10% bonus in the maximum permitted sign allowance for Freestanding Signs

may be provided if a Freestanding Sign is designed to integrate with the building structure. The sign is considered integrated if the same or similar building materials and colors are used. If there is disagreement whether a sign is integrated, the Director shall make a final decision. The bonus can be applied to both height and area.

- (b) *Landscape.* A 10% bonus in the maximum permitted sign allowance for Freestanding Signs may be provided if a Freestanding Sign is located within a landscaped area. The bonus may be granted if a minimum of 4 square feet of landscaping is provided for every 1 square foot of sign area. If the Freestanding Sign is integrated into a raised planter box, the landscaped area may be reduced to one square foot of landscaping for every one square foot of sign area. The bonus can be applied to both height and area.
- (c) *Building Location.* A 10% bonus in the maximum permitted sign allowance for Building Signs and Pedestrian Signs may be provided in the MUR, MUB, NB, and CB districts where the building is located within 10' of the street right-of-way, and where no Freestanding Ground Signs are constructed.
- (d) *Master Sign.* Any sign approved as a Master Sign through the Master Sign Program (as outlined in Section 6.5.5.e) may have an increase in area and height as follows:
 - i. *Area.* To qualify for an area bonus, a minimum of 4 tenants must contribute to the Master Sign. The area on a Master Sign may be increased by 50% for every sign removed or

by 8 square feet per tenant space on the sign – whichever is greater. However, in no case shall the sign exceed 400 square feet in total area.

- ii. Height. To qualify for a height bonus, a minimum of 4 tenants must contribute to the Master Sign. The maximum height of a qualifying Low-Profile Master Sign is 75% of the maximum height of a Freestanding Sign placed at the same location as the Master Sign. The maximum height of a qualifying Freestanding Master Sign is 125% of the Freestanding Sign's height allowance.

- (e) Near-interstate signs. Any parcel in a non-residential zone district and within 1000 ft of the I-25 or I-80 rights of way may have one extra Freestanding Sign which may have a bonus in area and height with the following regulations:

- i. 30' minimum clearance between the ground and the base of the sign
- ii. 60' maximum height
- iii. 200 square feet maximum area
- iv. Be located on the half of the parcel closest to the interstate right-of-way
- v. EMC size maximum may be increased from 25% of the allowed sign area to 40% of the allowed sign area
- vi. If the parcel abuts the interstate right-of-way, this 'extra' sign replaces the allowance for a ground sign for the interstate right-of-way street frontage
- vii. If the sign is within 350 linear feet of the property line of a duplex, single-family dwelling, or townhouse located in a residential zone district, the following modifications to requirements apply:
 - 20' minimum clearance
 - 40' maximum height
 - 100 square feet maximum area

c. **Electronic Message Centers.**

- 1. Electronic Message Centers shall be permitted accessory uses to any use classified as a Civic Use or as a Service – Entertainment Use in any zone district, subject to the following:
 - (a) Electronic Message Center allowed at up to 40% of the total allowed sign area.
 - (b) Properties utilizing this allowance may only place

Electronic Message Centers on low-profile ground signs.

- 2. Electronic Message Centers shall be permitted accessory uses to any use with a Drive-Through (Drive-in or Drive-up Facility) in any zone district, subject to the following:
 - (a) Electronic Message Center allowed as a Drive-Through sign at up to 100% of the total allowed sign area.
- 3. Electronic Message Centers may be allowed in the CB, MUB, CBD, P, AD, SS, BP, LI, and HI Districts, subject to the following:
 - (a) Electronic Message Center allowed on a Low-profile sign at up to 40% of the total allowed sign area.
 - (b) Electronic Message Center allowed on a Freestanding sign at up to 25% of the total allowed sign area.
 - (c) Electronic Message Center allowed as a Wall, Canopy, or Window sign at up to 32 square feet per elevation.
- 4. All Electronic Message Centers shall comply with the following.
 - (a) No animation, video, or other non-static display shall be allowed.
 - (b) No blinking, intermittent, flashing or moving lights shall be allowed.
 - (c) The message shall change no more than once every 8 seconds.
 - (d) Transitions between messages shall be accomplished in 2 seconds or less by employing immediate, dissolve, or fade method.
 - (e) Shall not increase the ambient lighting level by more than 0.3 foot candles when measured via a foot candle meter at any property line. A light-sensing device that adjusts the brightness as ambient light conditions change is required.
 - (f) Shall not be constructed within 50 linear feet of the property line of a Detached Dwelling, Semi-attached Dwelling, or Attached Dwelling unit located in any of the following zone districts: LR, MR, HR, NR-1, NR-2, NR-3, or MUR.
 - (g) Shall be constructed such that the face of the Electronic Message Center is perpendicular to the direction of travel on the adjacent street, and is located within 150 linear feet of the property line of a Detached Dwelling, Semi-attached Dwelling, or Attached Dwelling unit located in any of the

following zone districts: LR, MR, HR, NR-1, NR-2, NR-3, or MUR.(Subsection c(4)(g) does not apply to Drive-Through signs.)

6.5.5 Sign Plans & Permits

a. **Plan and Permit Requirement.** A sign plan shall be required on all construction of new buildings, remodeling of 50% or more of the exterior of a building, or change of use as follows:

1. Plans shall be presented to the Development Office with the site plan review application.
2. Plans shall be submitted to the Director with any building plans, and the Director shall determine the issuance of a sign permit(s) at the same time as the building permit.
3. No sign shall be erected without a building permit.

b. **Exemptions.** The following specific applications of sign types are exceptions to the permit requirement. They are in addition to the sign allowances in this section unless specified otherwise below. Any signs that exceed the exemptions provided below shall require a sign permit subject to all applicable district regulations:

1. All signs in place as of 6-14-93; provided that such signs were properly permitted at the time they were erected or no permit was required prior to erecting;
2. The changing of the advertising copy or message on a painted or printed sign allowed by this section, for theater marquees and other signs specifically designed for the use of replaceable copy;
3. Painting, repainting, cleaning or servicing of an advertising structure or the changing of the advertising copy or message of a sign allowed by this section, where no structural change is made;
4. Nonilluminated temporary signs, to the extent allowed by this section;
5. Nonilluminated incidental signs in residential districts, not exceeding three square feet in area, and relating to the safety and function of the site. Examples include "no parking," "no trespassing," "beware of dog" or other signs not related to the principle use of the site;
6. Nameplates and building markers not exceeding 1 square foot for every 10 linear feet of building frontage, but never more than 10 square feet;
7. Holiday, Cheyenne Frontier Days or other special event signs and decorations;
8. Government signs and other public safety symbols;
9. Window signs and signs in the interior of buildings, to

the extent allowed by this Section;

10. Flags or banners in residential districts not exceeding 3 per lot, no more than 30 square feet total, and no more than 15 square feet per flag or banner;
11. Flags in non residential districts not exceeding 3 per lot, no more than 60 square feet total, and not more than 30 square feet per flag.
12. Works of art that do not include a commercial message;
13. Nonilluminated barber poles.
14. Banners in non residential districts not exceeding 2 per lot, no more than 60 square feet total, and not more than 32 square feet per banner and attached flush to the wall of a building.
15. Signs which are easily placed and removed from the ground or building without needing additional structures, construction, or specialized equipment which relate to a candidate, issue, proposition, ordinance or other matter to be voted upon by the electors of the city.
16. Signs which are easily placed and removed from the ground or building without needing additional structures, construction, or specialized equipment which convey a philosophical, religious, political, charitable or other similar noncommercial message.

c. **Master Sign Program.** The purpose of a Shared Sign Program is to reduce the need for individual ground signs by integrating signage for multiple buildings or tenants into one or more shared signs. As an alternative to individual ground signs, the owners of lots within building complex such as a shopping center or industrial park may apply for and the Director may grant approval of a Shared Sign Program in accordance with the provisions of this section.

1. **Application Requirements.** An application for a Shared Sign Program shall include all information and materials required by the Department, and the filing fee set by the City's fee resolution. All owners within the area of the Shared Sign Program shall be required to sign a document waiving any rights to individual ground signs in exchange for signage on the shared sign(s). The application materials shall indicate the location of the proposed sign(s) and describe the method for allocating advertising space on the shared sign(s) among the various owners.

6.5.6 Compliance and Maintenance

- a. **Maintenance.** All signs shall be properly maintained by the business owner or proprietor. Sign surfaces and parts should remain clean, painted and in good working order.
- b. **Compliance.** Signs shall come into compliance with this Section should any of the following occur:
 - 1. If a sign is damaged or in need of repair, or the owner intends to remodel the sign, and the cost of repair or remodeling exceeds 50% of the sign's replacement cost, the repaired or remodeled sign shall come into compliance with this Section.
 - 2. If the business to which a sign relates changes use or name, the sign shall be brought into compliance with this Section.
 - 3. If a business closes for 12 months or longer and is reopened, the existing signs shall be brought into compliance with this Section.
- c. **Abandonment.** In the event a sign is abandoned for 60 days or longer, the Director shall notify the owner in writing of the violation. The notice shall follow procedures outlined in Section 1.3.
- d. **Certification.** All freestanding, billboard or ground sign permittees shall provide the Development Office and the Building Department, prior to final inspection, a certification attesting to the sign placement, the installed size and the installed height of the signs permitted, prepared and stamped by a Wyoming professional engineer or land surveyor. This certification shall attest to the sign support setbacks from property lines, overall dimensions of sign surface and the overall height of the top of sign from ground level.

6.5.7 Prohibited Signs

The following specific application of sign types are prohibited in all zoning districts, regardless of whether they meet the sign allowances of this Section:

- a. Signs that have been abandoned for sixty (60) days or longer;
- b. Signs imitating or resembling government signs for traffic direction or any other public safety symbol;

- c. Signs placed on vehicles or trailers for the primary purpose of displaying the sign(s), when such vehicle or trailer is parked and visible from the public right-of-way and is not used in the normal day-to-day operations of the owner or a business;
- d. Signs placed in or encroaching upon a public right-of-way, except:
 - 1. Awnings, projecting canopies, and marquees which comply with the provisions of these regulations and are at least 8' above the sidewalk;
 - 2. Bus stop benches and shelters, displaying signs on the backs of the benches, approved by the City through a request for proposal (RFP) process and a contract with a provider of the benches; and
 - 3. Portable signs which comply with these regulations.
- e. Building signs that extend vertically above the highest portion of the roof line or parapet, whichever is less.
- f. Portable signs, except that one sign per building entrance may be allowed as a permitted Pedestrian Sign in the CBD, NB, or MUB district, subject to the following:
 - 1. The sign consists of non-illuminated chalkboards or similar devices mounted on tripods, easels or pedestals;
 - 2. The sign shall not exceed 12 square feet and shall not exceed 5' height;
 - 3. The sign shall be located no more than 25' from the principal entrance to the building and removed from the premises during non-business hours; and
 - 4. If located in the right-of-way it shall be located in a manner that allows at least 6' clear area for pedestrian flow and meet all sight line triangle requirements.
- g. Signs on corner lots within the sight line triangle, except:
 - 1. Signs which do not exceed 2.5' above street grade, and
 - 2. Freestanding signs which have at least 12' of clearance above street grade and which do not have a support pole larger than 12" in diameter;
- h. Animated signs, except in the CB, BP, LI, or HI districts.
- i. Off-premise signs located on private property, unless approved as part of a temporary use permit.

6.5.8 Billboards

There shall be no increase in the overall number of billboard signs within the City limits. All billboard signs within the zoned area shall be brought into compliance with the district requirements upon any upgrade of the structure. This provision does not apply to any advertising copy change out.

- a. Billboards shall be permitted only in the MUB, CB, BP, LI, and HI zoning districts, except as provided in subsections (d) or (e).
- b. For a billboard sign requiring relocation, the billboard sign shall be allowed to be relocated, by the owner of the billboard, within the City, provided the billboard sign is installed and brought into compliance with the district requirements of the new site.
- c. For property being incorporated into the City limits that contains a billboard sign, the billboard sign shall be allowed to remain, if the billboard existed prior to 12-23-95. It shall be the owner's responsibility to provide proof that the billboard existed prior to 12-23-95.
- d. Owners of billboards within the City shall be allowed to remove a billboard and receive a credit to install a new billboard in the same or different location than the existing billboard on a 1 removed billboard for 1 new billboard basis.
- e. Owners of billboards within the City shall be allowed to remove a billboard and receive a credit to install a new digital billboard in the same or different location than the existing billboard on a 3 removed billboards for 1 new digital billboard basis.
- f. Credits issued under subsection a., c, or d, of this subsection are the tangible property of the owner of a removed or relocated billboard and shall be fully transferable or assignable provided the transferee or assignee meets the requirements of this Section and all other applicable provisions of the City Code.
- g. The message, messages, or copy displayed on a digital billboard:
 1. Shall not be displayed through blinking, intermittent, flashing, or moving lights.
 2. Shall remain fixed for at least 8 seconds.
 3. Shall not increase the ambient lighting level by more

than 0.3 foot candles when measured by a foot candle meter at:

- (a) 15' for a digital billboard with a surface area of not more than 242 square feet;
- (b) 200' for a digital billboard with a surface area greater than 242 square feet but not more than 378 square feet;
- (c) 250' for a digital billboard with a surface area of greater than 378 square feet but not more than 672 square feet; and
- (d) 350' for a digital billboard with a surface area greater than 672 square feet.

In no case shall a digital billboard increase the ambient lighting level by more than 0.3 foot candles at the property line of a single-family dwelling located in a zoned district in which billboards are prohibited. Each digital billboard shall have a light sensing device that will adjust the brightness as ambient light conditions change to conform to the requirements of this subsection.

4. Transitions between messages shall be accomplished in 2 seconds or less by employing immediate, dissolve, or fade method.
- h. The support column of a new or relocated billboard shall not be constructed within 150 linear feet of the property line of a duplex, single-family dwelling, or townhouse located in a zoned district in which billboards are prohibited.
 - i. Billboards are prohibited on roofs and walls.
 - j. Billboards on properties within 1,000' of Interstate 25 and Interstate 80 right-of-way shall conform to the following:
 1. Billboards shall not exceed 672 square feet in area. Proof of compliance with applicable laws, rules and regulations of the State of Wyoming shall be presented to the building official along with sign permit applications.
 2. Billboards on properties within 1000' of interstates on the same side of the interstate shall be at least 500' apart.
 3. Billboards shall not exceed 60' in height.
 - k. Billboards on properties outside the 1,000' of Interstate 25 and Interstate 80 rights-of-way shall conform to the following:
 1. Billboards shall not exceed 288 square feet in area.
 2. Billboards shall be at least 500' apart.
 3. Billboards shall not exceed 40' in height.

6.6 Residential Design Standards

- 6.6.1 Design Objective
- 6.6.2 Applicability
- 6.6.3 General Residential Design
- 6.6.4 Compact and Mixed-Density Neighborhood Design
- 6.6.5 Cottage Lots

6.6.1 Design Objective

The Design Objective of the Residential Design Standards is to:

- a. Ensure compatibility and a consistent character throughout the districts and neighborhoods;
- b. Promote a mix of building and dwelling types within the districts and neighborhoods;
- c. Allow for more compact residential development patterns that have a closer relationship of smaller lots and public streetscapes;
- d. Allow neighborhoods of greater density to be better integrated with adjacent mixed-use or commercial areas;
- e. Create neighborhood character and identity through a wide variety of diverse architectural details within a compatible range of residential building types and scales;
- f. Encourage pedestrian-scale design of buildings, breaking up larger elements of mass and volume into smaller scales, creating permeable facades that relate buildings to the public streetscape, and adding interest and details to buildings when viewed from the public realm;
- g. Balance vehicle access to sites with the pedestrian character of streetscapes.

6.6.2 Applicability

The Residential Design standards are grouped according to their applicability.

- a. Section 6.6.3 is generally applicable to all residential development.
- b. Section 6.6.4 is applicable where diverse, walkable and mixed density neighborhoods are desired. Specifically, they apply to the NR-1, NR-2, NR-3, and HR zoning

districts (except previously platted lots in HR), and in limited application to infill projects.

- c. Section 6.6.5 is applicable to cottage lot developments as an option for clustering dwellings.

6.6.3 General Residential Design

This section is generally applicable to all residential development.

a. *Open Space Design*

1. *Civic Open Space.* Residential developments that subdivide property shall meet all open space requirements through the open space design standards in the Subdivision Regulations, Article 4, Section 4.4.
2. *Site Open Space.* Where site development occurs without the subdivision of land, or where the lot does not have access to existing Civic Open Space systems within the service area guidelines in Section 4.4, each building shall have at least 200 square feet of open space per dwelling unit. Open space shall meet the Type, Design Standards, and Location criteria of Article 4, Section 4.4 with the following exceptions:
 - (a) Detached and Semi-attached dwelling units may count yards to the requirement provided no yard area less than 15' wide in any direction shall contribute to the requirement.
 - (b) Attached dwellings and Multi-dwelling units may count exterior balconies, decks, or other private and semiprivate outdoor space for up to 50% of the requirement.
3. *Reclamation.* To mitigate soil erosion and propagation of noxious weeds, areas of subdivisions and development sites which are not part of the open space design or where landscaping is not otherwise required or anticipated by the department, the developer or the homeowner shall reclaim all disturbed property and replant the entire area with native vegetation or landscaping. Topsoil shall be stock-piled and placed on disturbed areas. Irrigation shall be provided to the revegetated areas if it is necessary to ensure survival of native species planted. The grading plan shall include a section outlining the type and extent of revegetation proposed to accomplish this requirement.

b. Building Design

1. Encroachments.

- (a) Where the front building line is built at the front setback line, small projections such as bays, balconies, eaves and other minor projections integral to the structure and design may encroach up to 5' in front of the front building line, but in no case beyond the front lot line.
- (b) Porches and stoops associated with a front entrance may encroach up to 10' in front of the front setback line provided any roof or associated structure is no greater than a single story. See Figure 6-9.
 - (1) Shifted porches or side porches may encroach up to 50% of the side setback.

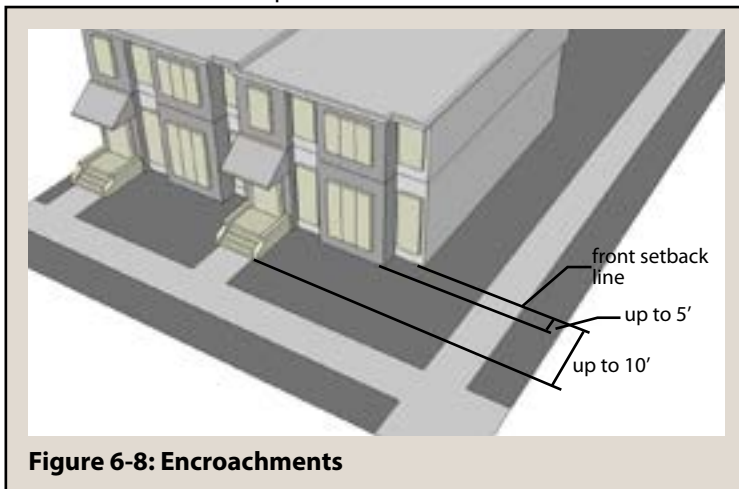

Figure 6-8: Encroachments

- (c) Uncovered decks and porches may encroach up to 50% of the required principal building side and rear setback, provided that no portion other than a handrail shall extend higher than 30 inches above the finished grade level.
- (d) Encroachments for accessibility such as handicap ramps attached and projecting from the foundation are not restricted, except that in no case will these accessibility encroachments extend into adjacent properties, easements or rights-of-way. Where accessibility issues and pedestrian access along the right-of-way are appropriately balanced and the design is consistent with the streetscape design, handicap ramps may be approved by the City Engineer according to the subdivision waiver procedures and criteria in Article 2.

- (e) These rules apply whether the encroachment as described in the section includes a foundation or not.
- (f) Exceptions to the height and setback requirements exceeding the allowances of this section may be considered by the Board of Adjustment through the Conditional Use process of Section 2.2.4.

2. Model Variations. Any development with 10 or more detached or semi-attached dwellings shall provide the following variations in models:

- (a) At least 3 models for 10 to 99 units; at least 4 models for more than 100 units;
- (b) Each model shall vary at least 3 characteristics which clearly and obviously distinguish it from other models. Distinguishing characteristics may include different:
 - (1) floor plans that result in a different building footprint;
 - (2) fenestration and exterior materials;
 - (3) entrance features as indicated in Section 6.6.4.a;
 - (4) roof lines;
 - (5) garage placement or orientation on the lot; or
 - (6) façade massing.
- (c) An applicant for a detached or semi-attached Building Permit shall affirm and certify in the application that the dwelling meets the variation in this section with respect to adjoining lots on the same block face.
- (d) Alternative Compliance: The Director may approve development without model variations according to this section where the Design Objectives of this section are best met by a different design approach, considering the context of the surrounding neighborhood. Approval shall be through the Administrative Adjustment procedures and criteria in Article 2, with the following additional criteria:
 - (1) Over 70% of each primary structure must be brick, stone or similar materials.
 - (2) No subdivision waiver is allowed for detached sidewalk and one irrigated street tree, of large canopy variety, is required per lot as a requirement of certificate of occupancy.
 - (3) The development includes no more than 20 units and is at least 1320' from any portion of another alternative compliance development area as described above.

TABLE 6-18: RESIDENTIAL BUILDING MATERIALS

Primary Materials	Accent / Trim Materials
Brick, unpainted (or equal or better simulated material) Stone, unpainted (or equal or better simulated material) Glass (Opaque) Metal Siding & Roofing (non-corrugated) Color Concrete Stucco (or equal or better simulated material) Horizontal Wood Clapboard (or equal or better simulated material) Wood shingles (or equal or better simulated material) Wood, aluminum, or fiber cement lap siding Wood, aluminum, or fiber cement board and batten siding	Any of the Primary Materials may be used as an accent material Wood trim (or equal or better simulated material) Precast stone, or wood moldings or similar architectural details (or equal or better simulated material)

3. *Materials for Multi-dwelling buildings.* All attached dwelling and multi-dwelling building types shall be constructed according to the following material standards. Percentage requirements for materials exclude windows or other openings. Carports, stand-alone canopies, or other structures which only consist of vertical support posts in the area between 2' and 8' above grade and are less than 2 stories in height shall be exempt from the materials requirements of this section.

- (a) **Primary Materials.** All buildings shall have not less than two primary materials covering at least 90% of the building facades. No one primary material may cover more than 70% of the facades. No one color may cover more than 70% of the facades (colors shall be distinctly different, if there is a debate over whether the proposed colors are distinctly different, an applicant may appeal the Director's determination to the Board of Adjustment).
- (b) **Accent Materials.** Buildings shall have at least one accent or trim material covering between 5% and 10% of the building facades. The accent shall be a separate material from the primary materials utilized on the building.
- (c) **Permitted Materials.** Exterior materials shall be permitted in accordance with Table 6-18.
- (d) **Material Changes.** Except for accent materials, changes in the facade material shall only occur at horizontal expression lines, with the heavier material below the lighter material. Alternatively, changes in the material may occur at differentiated

structural bays that meet the horizontal massing requirements.

- (e) **Equal or Better Simulated Materials.** Where "equal or better" simulated materials are permitted, they shall only be permitted by the Director as an Administrative Adjustment according to procedures and criteria in Article 2. The Director shall use the following additional criteria:
 - (1) The proposed material has an identical physical appearance as the material it intended to simulate, including color and texture, as perceived from any public spaces surrounding the property;
 - (2) The material presents benefits in addition to cost savings, such as reduced maintenance, or enhanced durability and performance;
 - (3) The material has a demonstrated track record of successful application and use that will result in equally long-lasting and sustainable appeal of the neighborhood as that of the permitted materials; and
 - (4) Use of equal or better materials may be conditioned upon compliance with all application and manufacturer specifications.
- c. **Infill.** Development in or adjacent to existing developed areas shall be compatible with the established architectural character, historic character and patterns of the neighborhood by using complementary designs including roof lines, patterns of door and window placement and characteristic entry features. Infill development, including infill in LR and MR districts shall meet the additional design standards in Section 6.6.4, Compact and Mixed-

ARTICLE 6

DESIGN REGULATIONS

6.6 RESIDENTIAL DESIGN STANDARDS

density Neighborhood Design. The Director may approve site designs with alternative compliance to the design standards in 6.6.4 for infill development where all of the following are met:

1. Alternatives to the Streetscape and Lot Frontage Standards in 6.6.4.a are only permitted if alley access is not available.
2. The deviation is the minimum needed for effective site design or is otherwise mitigated by enhanced site elements.
3. The proposal reflects historic development patterns in the neighborhood.

- d. **Alternative Compliance.** Detached Dwelling Lot Types and Semi-Attached Dwelling Lot Types may propose a principal building front setback of 15' when the standards in Compact and Mixed-Density Neighborhood Design (6.6.4) and access width standards in Table 4-13 are met. In existing neighborhoods the front setback shall not be less than the context of adjacent detached or semi-attached structures.

6.6.4 Compact and Mixed-Density Neighborhood Design

In addition to the general design standards in Section 6.6.3, compact and mixed-density neighborhoods (specifically NR-1, NR-2, NR-3, and HR zones; the residential component of MUR, MUB, and MUE zones; and Cottage Lot development) shall meet the following design standards.

a. Streetscape and Lot Frontage.

1. *Permitted Access.* The access type permitted for residential lots shall be based upon the lot frontage according to the following table.

Lot frontage ► ▼ Access Type	> 120'	75' to 120'	65' to 74'	55' to 64'	36' to 54'	< 36'
Alley / Shared Rear Access		<input checked="" type="checkbox"/>	<input checked="" type="checkbox"/>	<input checked="" type="checkbox"/>	<input checked="" type="checkbox"/>	<input checked="" type="checkbox"/>
Single-lane, Shared to Back	<input checked="" type="checkbox"/>	<input checked="" type="checkbox"/>	<input checked="" type="checkbox"/>	<input checked="" type="checkbox"/>	<input checked="" type="checkbox"/>	
Single-lane, Private to Back	<input checked="" type="checkbox"/>	<input checked="" type="checkbox"/>	<input checked="" type="checkbox"/>	<input checked="" type="checkbox"/>		
Single-lane, Private to Front	<input checked="" type="checkbox"/>	<input checked="" type="checkbox"/>	<input checked="" type="checkbox"/>			
Double-lane, Private to Front	<input checked="" type="checkbox"/>	<input checked="" type="checkbox"/>				
Unlimited, up to 15% Max	<input checked="" type="checkbox"/>					

- (a) Single lane access shall be between 8' to 10' wide.
- (b) Double lane access shall be no greater than 18' wide.
- (c) Shared access lanes may be located at or on property lines, subject to appropriate easements indicated on a plat or other similar and recordable instrument.
- (d) Private access lanes shall be at least 3' from any side property line.
- (e) Access design within the right-of-way shall be controlled by the standards in Article 4, Section 4.3.
- (f) The access width limitation shall apply to all areas within the front setback area. It may be expanded beyond the setback to accommodate circulation and access within the lot or lots sharing the access.

2. *Sidewalk Grades.* Vehicle lot access to individual lots shall not interrupt sidewalk grades or materials at sidewalk crossings.

3. *Pedestrian Access.* Each building and each front building entrance shall have one direct pedestrian connection from the public streetscape to the building entrance. Where front loaded driveways are permitted according to these standards a connection to the driveway or a combination driveway /pedestrian connection may satisfy this requirement.

4. *Front-loaded Garage Limits.* In addition to any general building setback standards in Article 5, the design of front-loaded, attached garage doors shall be limited as follows:

- (a) More than 40% of the front façade only permitted if set back greater than 50' from the front lot line.
- (b) Garage doors that occupy between 25% and 40% of the front façade shall be set back at least 20' from the front building line, or at least 50' from the front lot line, whichever is less.
- (c) Garage doors that occupy less than 25% of the front façade shall be built behind the front building line, or at least 35' from the front lot line, whichever is less.
- (d) Where front-loaded garage doors are prohibited by effect of these standards, garages shall be located on the side or back of the principal structure, or in an approved detached accessory structure, subject to the standards in Article 5.
- (e) In cases where the garage doors face side yard lines, the garage corner nearest the front lot line shall be at least 35' from the front lot line.
- (f) The Director may approve alternative designs as

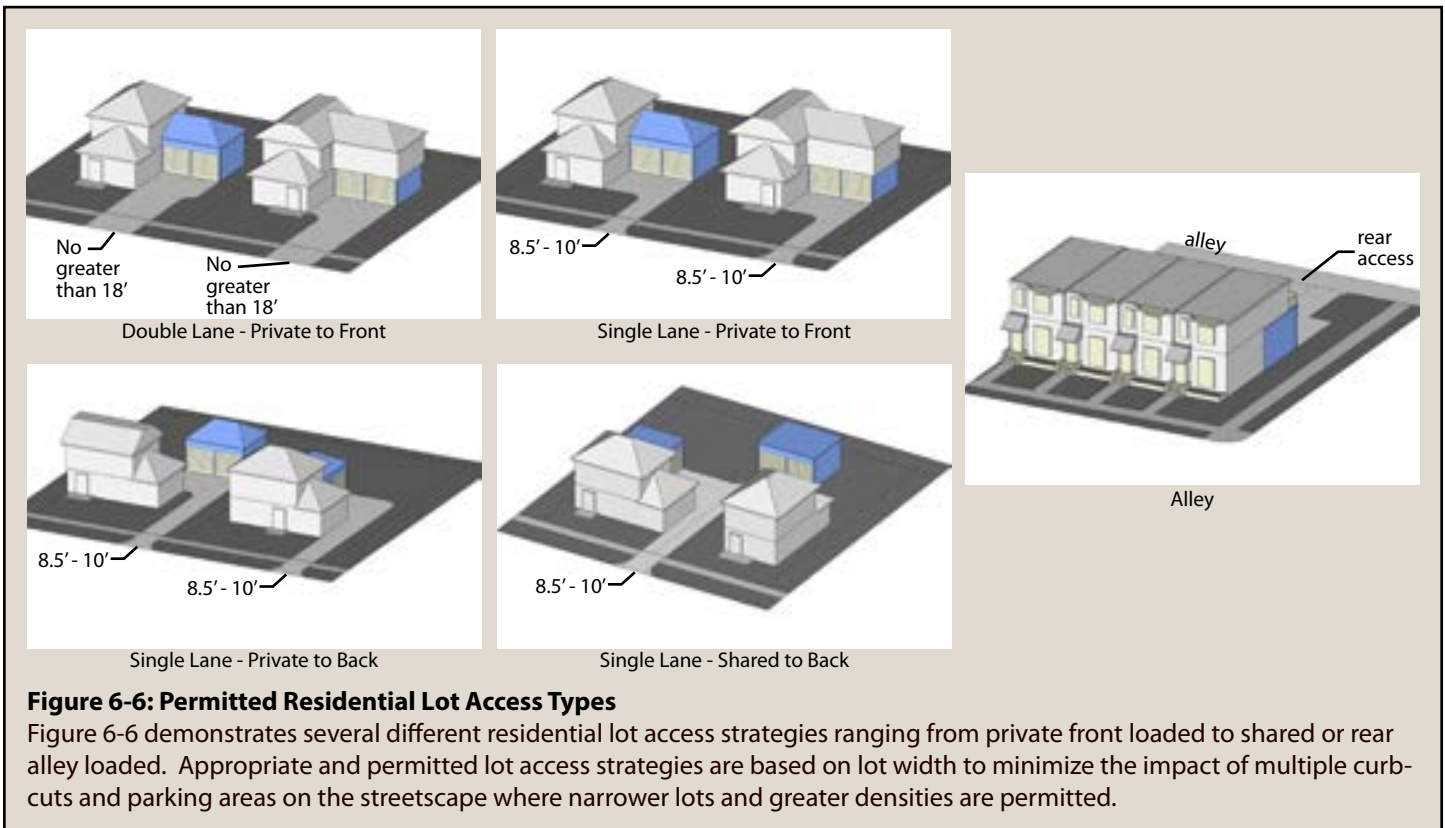

Figure 6-6: Permitted Residential Lot Access Types

Figure 6-6 demonstrates several different residential lot access strategies ranging from private front loaded to shared or rear alley loaded. Appropriate and permitted lot access strategies are based on lot width to minimize the impact of multiple curbs-cuts and parking areas on the streetscape where narrower lots and greater densities are permitted.

exceptions to these limitations where, due to topography or other unique elements of the site design and building orientation, the proposed garage doors will have a lesser impact on the public streetscape than is otherwise allowed by the standards.

b. Building Design.

1. *Entrance Features.* All buildings shall have one primary entrance feature on the front façade emphasized with structural components or architectural details and ornamentation that complement the overall building design. See Figure 6-9.
2. *Façade Openings.* The front façade shall have at least 15% of the façade area occupied by openings of windows and doors. Garage doors shall not contribute to the openings, but facing garage doors shall contribute to the facade area. Windows on garage doors may contribute to the openings.
3. *Horizontal Massing.* Any front building façade with a width greater than 50' shall have differentiated horizontal massing through the use of any one or a

combination of the following:

- (a) Differentiated structural bays every 18' to 36', demonstrated by a vertical expression line of trim or ornamental architectural elements that distinguish it from the rest of the facade;
- (b) Small off-sets in the façade between 2' and 5', associated with internal floor plan of the building and resulting in between 20' and 50' horizontal distance along each off-set segment; or
- (c) An intervening courtyard, garden or other open space meeting the requirements of Section 6.6.3.a and resulting in no single portion of horizontal façade greater than 50'.
4. *Vertical Massing.* Any building that is 3 stories, or more where specifically permitted, shall have differentiated vertical massing through the following:
 - (a) A base comprised of the first story, differentiated by a horizontal expression line of trim or ornamental architectural elements that distinguish it from the rest of the facade, or by a single story porch or stoop roof structure associated with the entrance and covering at least 50% of the facade;
 - (b) A cap comprised of one of the following:

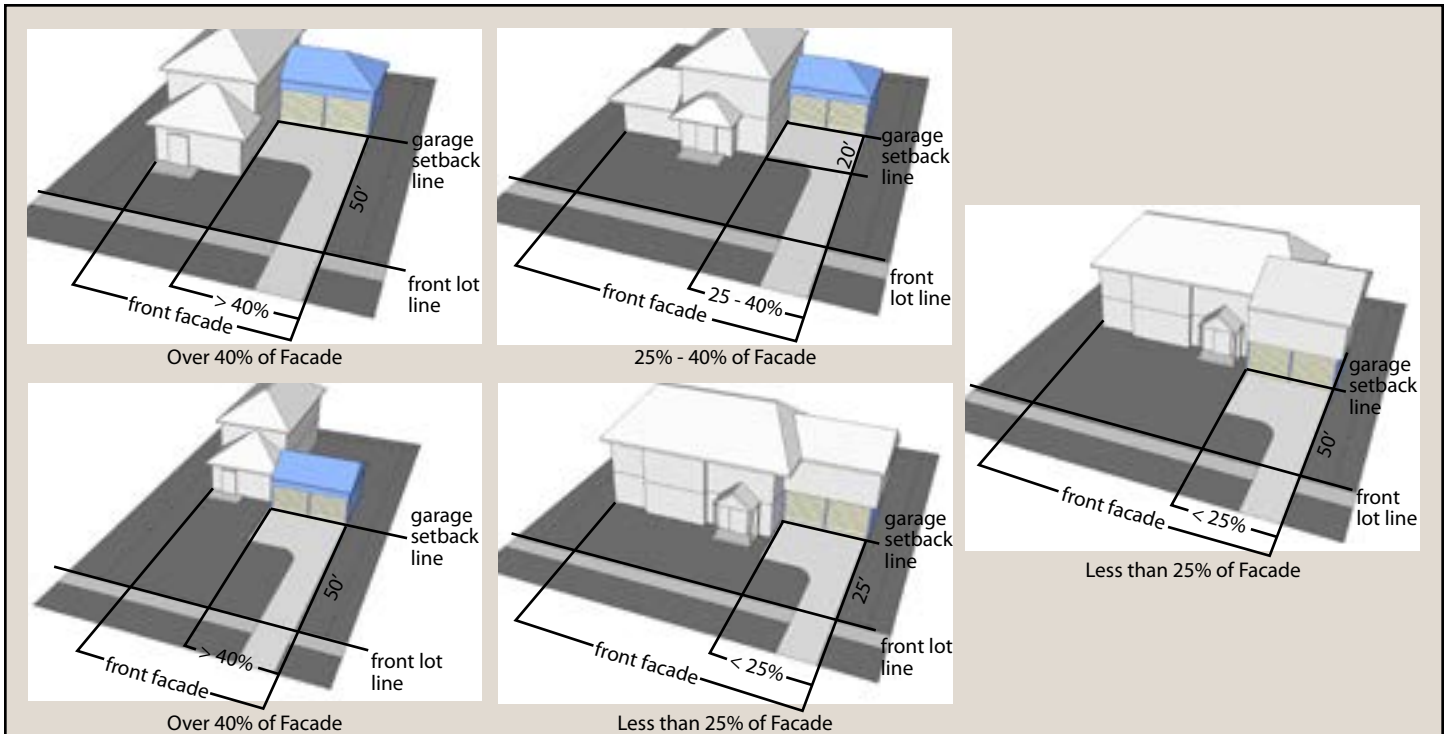

Figure 6-7: Front Loaded Garage Limits

Figure 6-7 demonstrates several different design approaches that minimize the impact of front loaded garages on residential streetscapes. Pedestrian-scale residential building design and orientation – reflected in this case by the percent of the façade dedicated to front-loaded garages - becomes more important for residential streetscapes where narrower lots, greater densities and lesser setbacks are permitted.

- (i) An eave line ornamental trim differentiating the roof structure where pitched roofs are used;
- (ii) A cornice or similar horizontal expression line differentiating the uppermost 10% to 15% of the façade, including the parapet where flat roofs are used; or
- (iii) Where buildings more than 3 stories are specifically permitted, in addition to the expression line required by sub-section (b)(ii), the upper story shall be differentiated with a similar horizontal expression line or a step back of the upper story of at least 10'.



Figure 6-9: Residential Building Entrances

Simple variations in the ornamentation and design of entrance features can add great diversity to the streetscape even when applied to the same or similar building type. These examples show some possibilities of how ornamentation (arch, peak, shed, or flat) and features (stoop, portico, half porch, shifted porch, or full porch) can be combined to add variety within similar scales and mass.

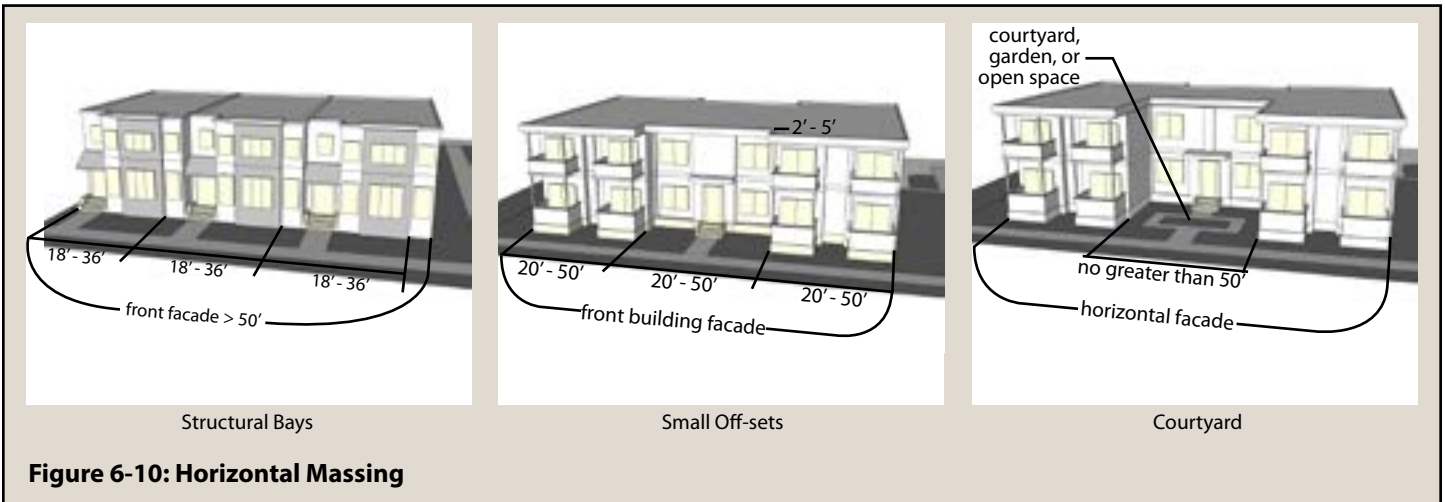

Figure 6-10: Horizontal Massing

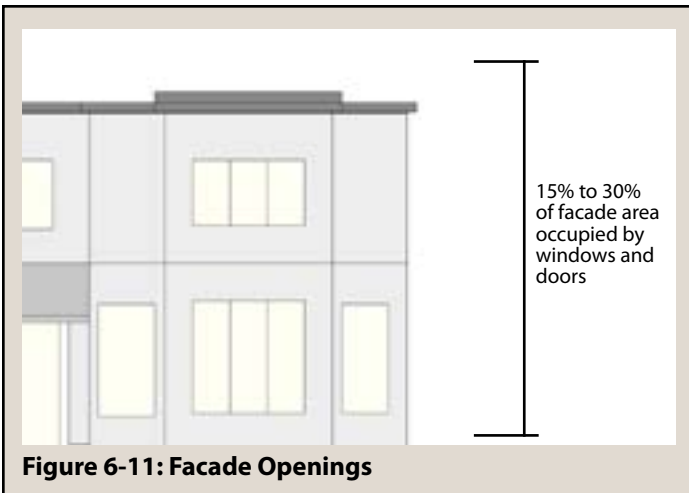

Figure 6-11: Facade Openings

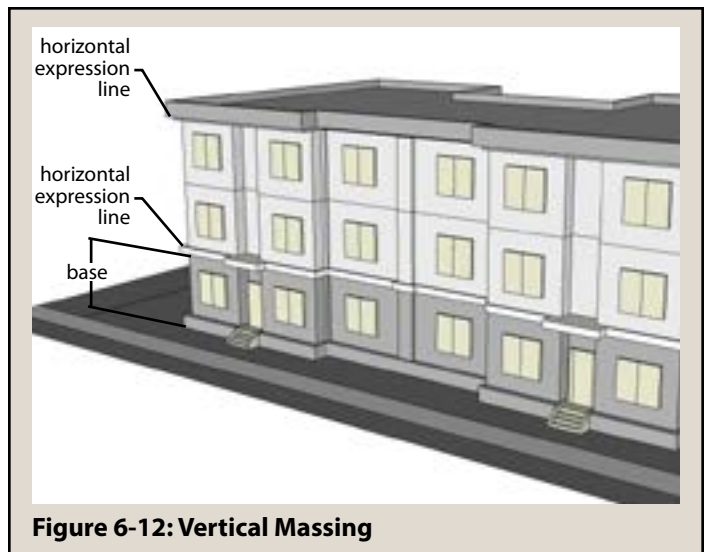

Figure 6-12: Vertical Massing

6.6.5 Cottage Lots

The Cottage Lot option is intended to allow development on more difficult infill lots and provide for innovative new development by permitting more flexible arrangements of accesses, buildings, and open spaces, in a manner that best meets the overall civic and urban design goals for the general neighborhood. Where Cottage Lot development is allowed, detached, semi-attached, or attached structures may be arranged in a cluster option according to the standards of the eligible lot types, except as modified by the following additional standards:

a. All street connectivity and block standards of these regulations shall apply.

b. Dwelling units on a single lot or utilizing condominium ownership shall comply to the following lot and building standards:

1. The minimum lot area is based on unit style and zoning; the lot must provide the area equivalent of 80% of the required area for the number of units of the respective building type in that zone district (for example, if 10 detached-dwelling-style units are proposed in the LR zone, the minimum lot area is the minimum required lot area for one detached dwelling in the LR zone, multiplied by 10, multiplied by 0.8).
2. There is no minimum lot frontage along the public street.
3. The maximum lot coverage is 80%.

ARTICLE 6

DESIGN REGULATIONS

6.6 RESIDENTIAL DESIGN STANDARDS

4. The maximum number of stories is 3.
 5. Setbacks from all streets shall be 25'.
 6. Side and rear setbacks shall be 15'.
 7. Each dwelling unit shall have a designated "front" meeting the design standards of 6.6.4.
 - (a) The front of the dwelling unit may face the public street, a common open space, an internal access street, or a parking area.
 - b) Where the front of a dwelling unit faces an internal access street, the standards of 6.6.4.a.1 and 6.6.4.a.4 do not apply to the internal access street.
 8. Each dwelling unit shall have a pedestrian connection to common open space, parking lots (if applicable), and the public street.
 9. Dwelling units abutting a public street shall be oriented to the public street, with the following exceptions:
 - a) The side of a dwelling unit may be oriented to the public street and receive a 10' setback from the public street when all of the following are present:
 - (i) The front façade of the dwelling unit is oriented to a common open space;
 - (ii) The side façade is also treated as the front façade for all building design standards except entrance features; and
 - (iii) There is a pedestrian connection from the front entrance to the public street sidewalk.
 - b) The side or rear of a dwelling unit may be oriented to the public street if the public street is designated as a Major Collector, Arterial, or Interstate, and the structure meets street setbacks. In such cases, a 6' high fence may be placed between the building and the public street meeting all other fencing regulations. Each dwelling unit must front upon a common open space, an internal access street, a parking area, or other public street.
 10. A common open space area is provided according to the standards of 6.6.3.a.2.
- c. Dwelling units utilizing fee simple ownership for each unit shall be allowed utilizing the allowed lot and building standards for that respective style of dwelling unit within the zone district, with the following modifications:
1. Lots may front on a common open space instead of a public street, provided the open space is designed according to one of the Civic Open space types in Section 4.4. The open space shall have direct frontage along the public street.
 - (a) The required lot frontage for each lot fronting on the common open space may be reduced by up to 10'.
 - (b) Front setbacks for lots fronting on common open space may be reduced to 0'.
 2. Lots may front upon a private internal access way or parking area, with the following modifications:
 - (a) No more than 40% of the lots within the development front an internal access way or parking area.
 - (b) There is a common open space located within the development.
 - (c) Each lot has a pedestrian connection to common open space, parking lots (if applicable), and the public street.
 - (d) The lot meets frontage, area, setback, and coverage requirements of the respective lot type; except as otherwise allowed in this section.
 - (e) The standards of 6.6.4.a.1 and 6.6.4.a.4 do not apply to the internal access way.
 - (f) Any garage is setback a minimum of 22' from the edge of the sidewalk paralleling the access way (if a sidewalk is not provided parallel to the access way, then the garage shall be setback 22' from the edge of the internal access way's pavement).
 3. The required lot area for each lot adjacent to a common open space may be reduced by up to 50%, provided that each lot has direct access to common open space that, when combined with the reduced lots, is no less than 80% of the required area for the number of lots.
 4. The maximum lot coverage for each lot adjacent to the common open space may be increased to 90%. The overall coverage of the development site shall be no greater than 80%.
 5. Rear setbacks abutting non-clustered lots shall be the same as required for that lot type; rear setbacks abutting other lots within the cluster development may be reduced to 0'.
 6. All lots abutting a public street shall have buildings oriented to the public street. The side of the building may be oriented to a public street when all of the following are present:
 - (a) the front façade of a building is oriented to common open space;
 - (b) the side façade is also treated as the front façade for all building design standards, except entrance features;
 - (c) there is a pedestrian connection from the front entrance to the public street sidewalk; and
 - (d) there is no direct vehicular access to the public street.
 7. An address monument shall be provided at the public street.

- d. Common Open Space. Where a common open space is provided the following standards apply:
1. Any portion of the common open space abutting a front façade shall provide a minimum of 30' between structures, or 20' from the structure on a Cottage Lot and the property line of a parcel which is not part of the Cottage Lot development.
 2. Any portion of the common open space abutting a side or rear façade shall provide a minimum of 10' between structures, or 5' from the structure on a Cottage Lot and the property line of a parcel which is not part of the Cottage Lot development.
 3. The common open space shall provide pedestrian connections between front doors of the dwelling units, common open space amenities, parking lots (if applicable), and the public street.
 4. The common open space may provide limited vehicle access, provided that:
 - (a) the aesthetic and functional design of this space is primarily for the Civic Open Space design type. Examples include a courtyard or plaza that allows discrete vehicle access across the surface, or a green that includes a small lane of approximately 8' to 10' wide for vehicle access, constructed with materials that complement the primary design intent for the area as Civic Open Space.
 - (b) the common open space width minimum is increased by the width of the vehicle access space.
 - (c) Front vehicular access to dwelling units are limited to the standards of 6.6.4.a, except that all lots with less than 75' of frontage shall be considered 65' to 74' wide for the purposes of compliance with Table 6-19.
 5. The common open space is designed to the standards of 4.4.
- e. Parking, access, and circulation:
1. Required parking shall be located within 300' of the dwelling unit. Parking, whether surface spaces or in garages shall be setback from the public street or lot lines of non-clustered lots by at least 30', or screened from view by a parking lot perimeter buffer.
 2. Private internal access ways shall have the following minimum paved widths:
 - (a) 28' if providing two-way traffic
 - (b) 18' if providing one-way traffic
 - (c) Minimums pursuant to fire code if required for providing fire access
 3. Where provided, parking lots shall comply with all standards of 6.2.8.
 4. Minimum parking may be considered as "Residential: all others" for purposes of compliance with Table 6-2.
 5. Two access points are required if providing more than 30 units.
 - f. Maintenance and management of common areas shall be provided by a homeowner's association or other similar entity and shall be established at the time of final plat for multi-lot development.
 - g. Any fencing internal to the project and abutting common open space shall be limited to a maximum of 4' high, and have at least 33% transparency. Examples of this transparency include a 2'8" solid wall (66% of 4' solid; 33% of 4' void) or a 4' high picket fence with a 2:1 or less solid: void ratio (66% solid; 33% void). All fences shall be designed with materials and style to complement the materials and architectural styles of the buildings, and complement the urban design concepts in the open space. On rear yards, privacy fences up to 6' high may be erected on rear lot lines directly adjacent to the rear lot lines of noncluster lots and on rear yards within the principle building setback area.
 - h. All development utilizing this option shall comply with the design standards of 6.6.4 unless otherwise noted in this Section.
 - i. Whether utilizing the single lot or multiple lot option, development proposed under this section shall submit a site plan in accordance with Section 2.2.3. For developments utilizing the multi-lot option, the site plan is only required for the common areas. In addition to all review and submittal requirements in Article 2, the application shall demonstrate the coordination of the construction of common areas with the building on individual lots. No Certificate of Occupancy shall be permitted for any building until adequate common areas that serve each lot are constructed.

6.7 Small Scale Commercial and Mixed-use Design Standards

- 6.7.1 Design Objective
- 6.7.2 Applicability
- 6.7.3 Streetscapes and Lot Frontages
- 6.7.4 Open Space Design
- 6.7.5 Building Design
- 6.7.6 Site Screening
- 6.7.7 Interpretation of Design Guidelines

6.7.1 Design Objective

The Design Objective of the Small-scale Commercial and Mixed-use Design Standards is to:

- a. Enhance the community character in more compact commercial or mixed use development patterns.
- b. Improve the design of commercial and mixed use areas to allow a close relationship to supporting neighborhoods.
- c. Create character and identity through a wide variety of diverse architectural details within a range of compatible building forms and scales.
- d. Integrate new buildings into the existing context of the community.
- e. Emphasize the relationship and orientation of buildings and sites to public streetscapes and open spaces, and to complement investment in the public realm.
- f. Improve the pedestrian level of service through directness, continuity, street crossings, visual interest and amenity, and security.
- g. Encourage quality construction and improve sustainability with durable, adaptable, and re-usable buildings.

6.7.2 Applicability

These standards apply to mixed-use activity centers, small scale commercial districts near neighborhoods, or other similar areas where diverse, walkable environments are desired. Specifically, they apply to new construction and additions to buildings in the following zoning districts:

- a. NB
- b. MUR
- c. MUB
- d. PUD, but subject to modification through the planning and review process.
- e. NR-3, for the urban loft building type.

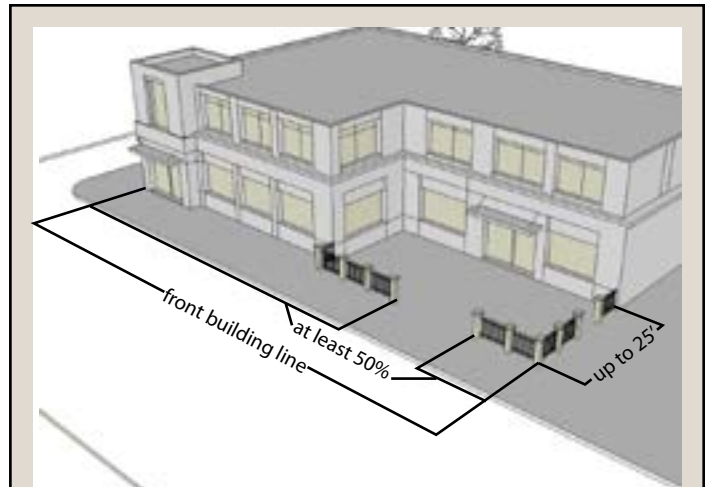

Figure 6-13: Required Building Frontage

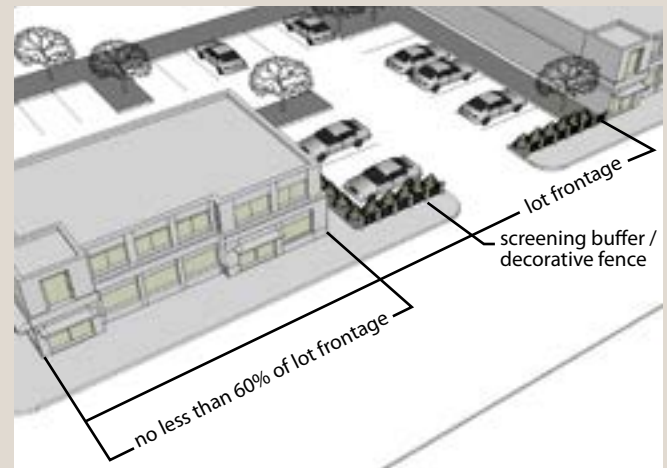

Figure 6-14: Alternative Street Wall

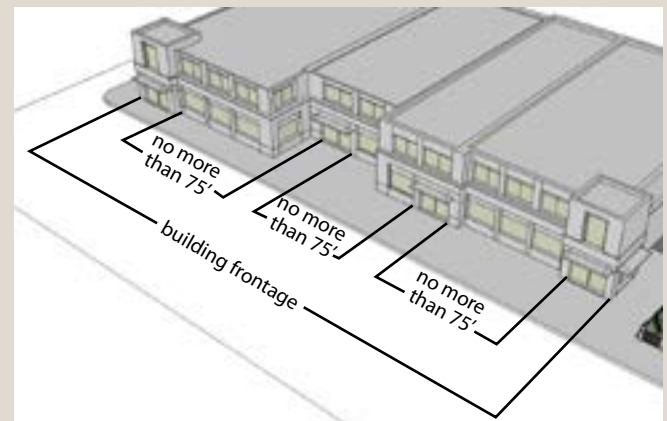

Figure 6-15: Primary Entrance Feature

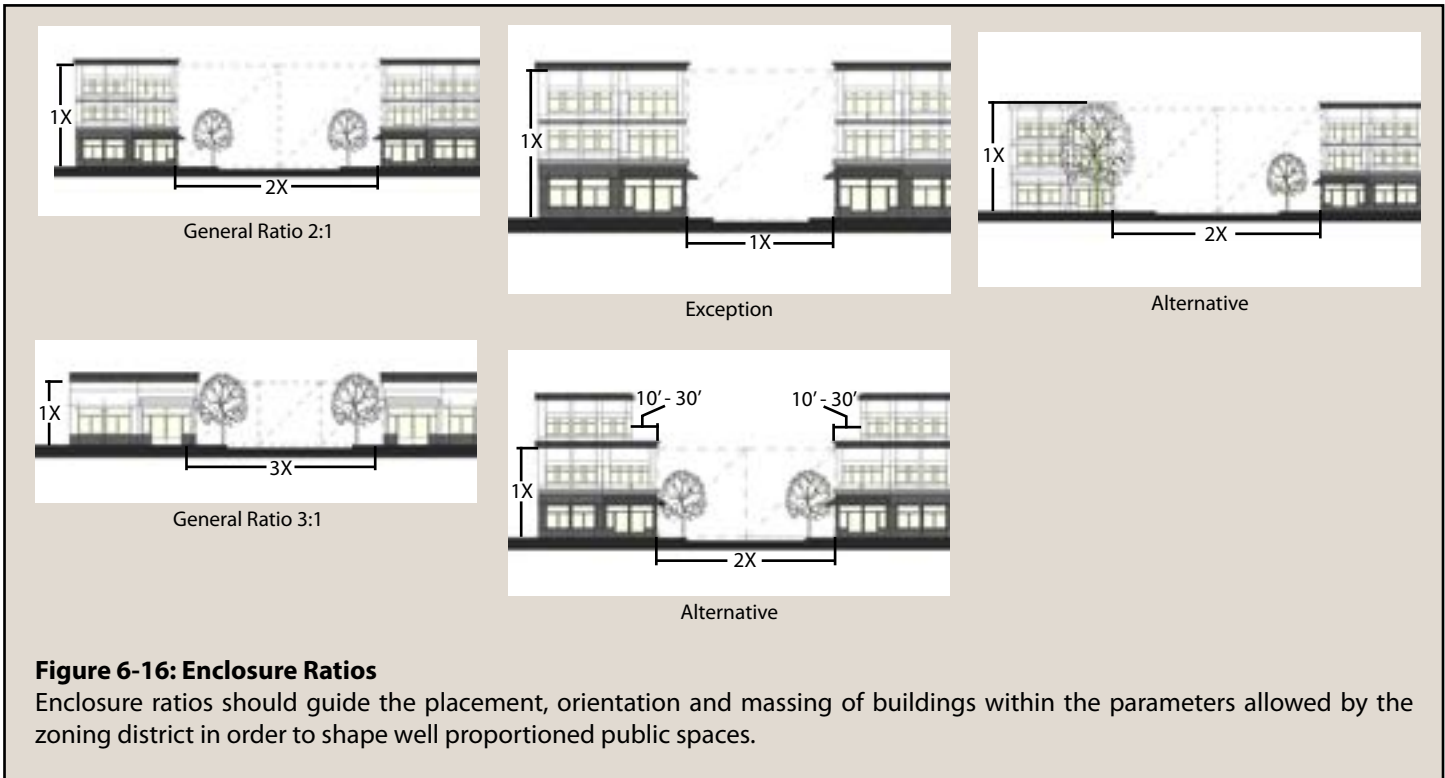

Figure 6-16: Enclosure Ratios

Enclosure ratios should guide the placement, orientation and massing of buildings within the parameters allowed by the zoning district in order to shape well proportioned public spaces.

- f. The City Council may elect to apply all of the Small-Scale Mixed Use and Commercial Design Standards in Section 6.7 as a condition to rezoning to the CB district if it is located in an Activity Center designated in the Comprehensive Plan or if a pedestrian oriented environment is desired.

6.7.3 Streetscapes and Lot Frontages

- a. **Required Building Frontage.** The primary façade shall occupy at least 75% of the required front building line along the frontage, except:
 1. Where the primary building entrance is accessed by a courtyard, plaza or similar civic open space along the streetscape, the front building line may be setback as much as 25'. At least 50% of the lot frontage along the street shall be either building façade or an alternative street wall between 2.5' and 4', and matching the materials or ornamentation of the building.
 2. On secondary or support streets that are not the primary pedestrian and retail streets for the area, the Director may approve an exception for a building façade that occupies as little as 30% of the front building line, provided it does not impair the design standards for the public streetscape and is consistent with the site design of adjacent property. The Director

may require landscape elements, low ornamental walls or similar design details as alternate street walls, particularly at any corner location.

3. Where on-site parking is permitted to the side of the building, according to Section 6.2 the primary façade can occupy as little as 60% of the front building line. An alternative street wall of between 2.5' and 4' and matching the materials or ornamentation of the building shall be at the extension of the front building line to screen parking areas.
 4. Buildings designed for Civic Uses may have greater setbacks provided the building façade orients to the street and any space between the building and public street is designed as Civic Open Space.
- b. **Primary Entrance Feature.** Any façade that faces a public street or civic open space shall contain a single-story primary entrance feature subject to the following:
 1. The primary entrance feature shall have enhanced architectural details such as a canopy or arcade, recessions of up to 5' and decorative moldings, framing, or roof and awnings.
 2. Primary entrance features shall occur at least every 75' along a building frontage. Where a single tenant

occupies more than 75' of building frontage, the facade shall be differentiated by horizontal massing techniques specified in Section 6.7.5, and primary entrance features may occur every 125' along the building frontage.

c. **Enclosure Ratio.** Enclosure Ratio refers to the relationship of opposing building frontages across a streetscape – specifically the building separation (distance between opposing facades) to building height. The enclosure is important for achieving the scale, comfort and character of streets in pedestrian-oriented commercial and mixed-use centers – essentially framing the “public realm” of the streetscape. Spaces greater than the standards below result in ill-defined or poorly proportioned streetscapes and lack a clear public realm. Spaces less than the recommended enclosure can result in the perception of confined or congested areas. The Enclosure Ratio shall not alter any specific or required building height maximums or setbacks and built-to requirements for any particular zoning district, but may guide site and building designs dealing with the placement, orientation and massing of buildings within the parameters allowed by the zoning district.

1. **General Ratio.** In general and on primary retail and pedestrian-oriented streets in commercial development patterns the Enclosure Ratio shall be within a range of 2:1 to 3:1.

2. **Exception.** Ratios as tight as 1:1 may be appropriate on blocks that are short (less than 400') and on narrower side streets.

3. **Alternatives.** Where building heights are allowed and approved which would result in less than the recommended enclosure ratio, the lower story(ies) should maintain the ratios, and upper stories should be stepped back between 10' and 30' of the front building line, or other open spaces should occur along the streetscape. Where building heights or building locations are allowed and approved which would result in less than the recommended enclosure ratio, alternative vertical elements such as tall trees or other urban design elements should be used to supplement the enclosure at these specific locations.

6.7.4 Open Space Design

Open space shall be required as provided in the Subdivision Regulations, Article 4, Section 4.4. Where site development occurs without subdivision of land, and where the lot does not have access to the Civic Open Space system within the service area guidelines required by the Subdivision Regulations, open space shall be provided on the lot subject to the following:

a. **Commercial or Mixed-use Buildings.** On-site open space shall be 5% of the building footprint plus an additional 1% for each story of the building greater than 2 stories.

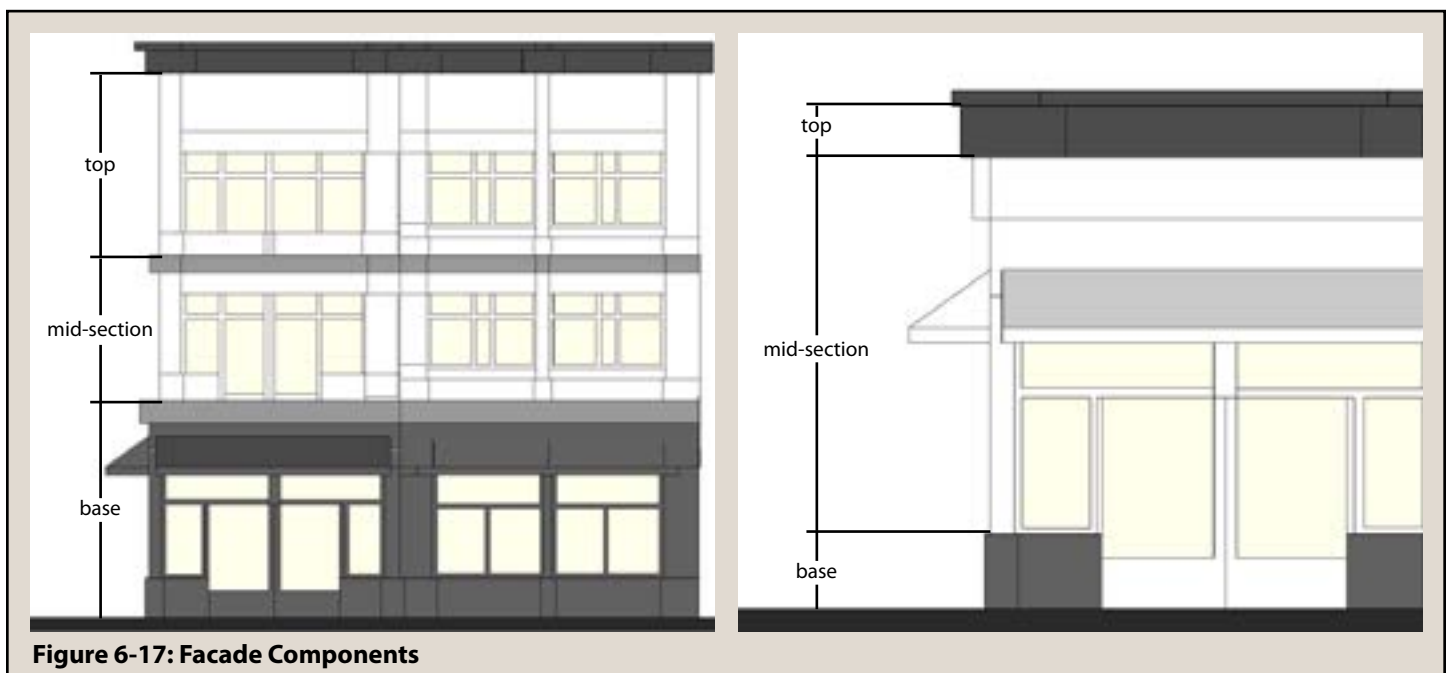



Figure 6-18: Facade Openings

- b. *Large Buildings.* On-site open space for building footprints with over 50,000 square feet shall be 8% of the building footprint plus an additional 1% for each story of the building greater than 2 stories.
- c. *Residential.* Any residential buildings shall provide at least 150 square feet per dwelling unit, except that up to 40% of this requirement may be accommodated by outdoor decks, balconies or similar private or common open space.
- d. *Design.* On-site open space shall meet the Type, Design Standards and Location Criteria of Article 4, Section 4.4 of the Subdivision Standards.

6.7.5 Building Design

Any façade that faces a public street, Internal Access Street, or Civic Open Space shall contain the following façade design features.

- a. **Façade Components.** Each façade shall have components differentiated with a change in materials, projections or ornamental architecture to decrease vertical massing (base, top, and mid-section) and horizontal massing (structural bays and façade breaks) for longer building facades. Standards for decreasing vertical and horizontal massing are:
 - 1. *Base.* The base shall be directly at grade and support storefront window sills, and consist of the lower 10% to 35% of the building height, but never more than the first story.
 - 2. *Top.* The top shall be the upper most 5% to 25% of the façade and differentiated with a continuous horizontal architectural treatment such as a cornice line or parapet, except that on pitched roof structures, the eave and roof structure shall be the top. Where any

buildings of 4 stories or more are permitted, the upper story may be differentiated as the top.

- 3. *Mid-section.* The mid-section shall be all portions of the façade that are not the base or top and may consist of primary materials, secondary materials and window openings, and shall account for at least 50% of the façade.
- 4. *Horizontal Massing.* Any building with a front façade with a width greater than 150' shall have differentiated horizontal massing through any combination of the following:
 - (a) Differentiated structural bays every 25' to 50', demonstrated by a vertical expression line of trim or ornamental architectural elements that distinguish it from the rest of the façade;
 - (b) An intervening courtyard or plaza meeting the requirements of sub-section 6.7.4, resulting in no single portion of horizontal façade greater than 75'.
- b. **Façade Openings.** Each facade facing a street shall have openings at street level and upper levels according to the following:
 - 1. Between 60% and 90% of all street-level facades between 2' and 10' above grade shall be transparent with views to the interior of the building. No window starting at a level of greater than 3.5' above the street level should be included in the calculation.

Exceptions:

 - a) Covered porches or arcades using the same primary or secondary materials as the building and designed to integrate with the building architecture are considered 'openings' for the purposes of this section of code.

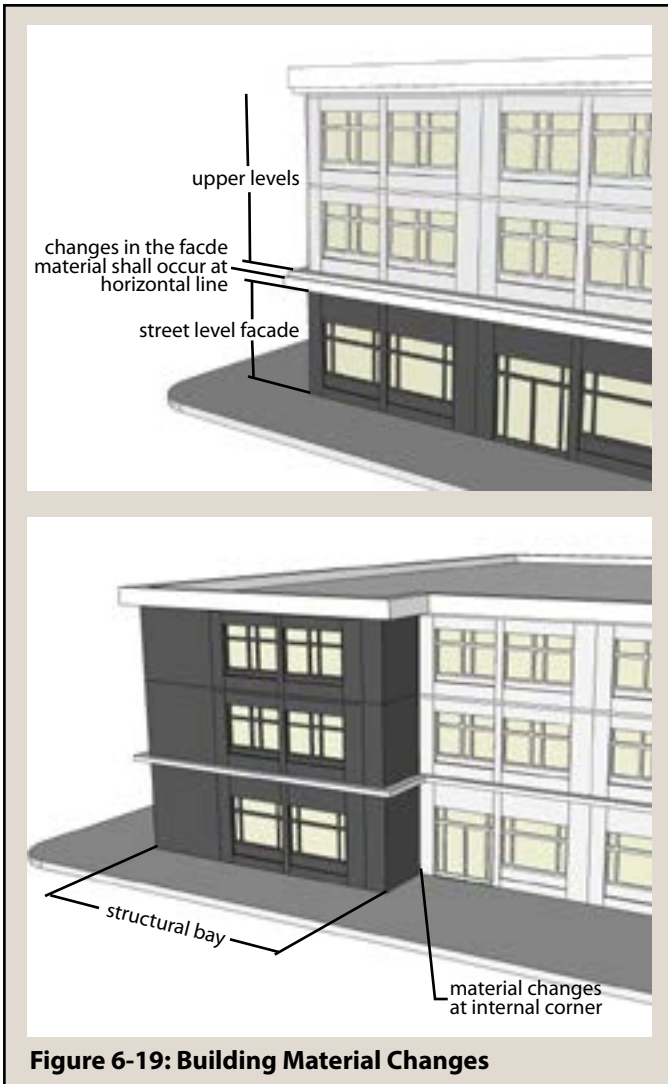

Figure 6-19: Building Material Changes

- (b) Where the interior operation or program of the building warrants screening from the street, façade architectural treatments creating a desirable pedestrian experience may be substituted for the transparent window as approved by the Director, such as a closed display window, of at least 2.5 feet deep may be substituted along up to 50% of the linear distance of the façade translucent glass, opaque glass, cantilevered arcade, or other architectural features built into the wall of the building to create visual interest and rhythm at a pedestrian scale.
- (c) Any section of a building with residential dwelling units on the floor that predominately covers the space between 2' and 10' above grade may provide openings in the areas where the

residential units are located in compliance with the requirements for upper level openings (below) as an alternative compliance.`

- 2. No more than 20' of building frontage shall exist at the street level without window or door openings. On secondary or support streets that are not the primary pedestrian and retail streets of the Center, the Director may approve facades with greater than 20' of building frontage without window and door openings.
 - 3. Upper level openings shall occupy between 20% and 50% of the façade and consist of punched and regularly spaced openings to create a rhythm and pedestrian scale for the façade.
 - 4. Corner buildings with two street frontages may designate one frontage as the primary frontage; however, at least the first 30' of secondary frontage from the corner shall meet the above minimum opening requirements.
- c. **Building Materials.** All buildings and accessory buildings over 200 square feet shall be constructed according to the following material standards. Percentage requirements for materials exclude windows or other openings. Carports, stand-alone canopies, or other structures which only consist of vertical support posts in the area between 2' and 8' above grade and are less than 2 stories in height shall be exempt from the materials requirements of this section.
- 1. **Primary Materials.** All buildings shall have one primary material covering at least 30% of the building facades. Buildings which are more than 50% residential dwelling units (by square footage) may use any of the Secondary Materials as a primary material provided:
 - (a) No less than 2 primary/secondary materials are used;
 - (b) No one primary/secondary material covers more than 70% of the facades; and
 - (c) No one color covers more than 70% of the facades (colors shall be distinctly different, if there is a debate over whether the proposed colors are distinctly different, an applicant may appeal the Director's determination to the Board of Adjustment).
 - 2. **Secondary Materials.** Buildings may have a secondary material covering up to 70% of the facades.
 - 3. **Accent Materials.** Buildings shall have at least one, and may have up to two accent or trim materials covering between 5% and 10% of the building facades. The accent shall be a separate material from the primary materials utilized on the building.
 - 4. **Permitted Materials.** Exterior materials shall be permitted in accordance with Table 6-20.
 - 5. **Material Changes.** Except for accent materials, changes

ARTICLE 6 DESIGN REGULATIONS

6.7 SMALL SCALE COMMERCIAL AND MIXED-USE DESIGN STANDARDS

in the façade material shall only occur at horizontal expression lines, with the heavier material below the lighter material. Alternatively, changes in the material may occur at differentiated structural bays that meet the horizontal massing requirements of Sub-section a above.

6. *Equal or Better Simulated Materials.* Where “equal or better” simulated materials are permitted, they shall only be permitted by the Director as an Administrative Adjustment according to procedures and criteria in Article 2. The Director shall use the following additional criteria:
 - (a) The proposed material has an identical physical appearance as the material it intended to simulate, including color and texture, as perceived from any public spaces surrounding the property;
 - (b) The material presents benefits in addition to cost savings, such as reduced maintenance, or enhanced durability and performance;
 - (c) The material has a demonstrated track record of successful application and use that will result in equally long-lasting and sustainable appeal of the neighborhood as that of the permitted materials; and
 - (d) Use of equal or better materials may be conditioned upon compliance with all application and manufacturer specifications.

- d. **Alternatives.** Minor deviations from these standards may be evaluated by the Director in accordance with the process and procedures for an Administrative Adjustment as described in Article 2. In addition to the review criteria described in Article 2 the Director shall also evaluate the proposal using the design objectives of the section as additional criteria. Where a proposal offers a unique building design that is not accommodated by minor adjustments as described above, then the process and procedure for a Planned Development in Article 2 may be followed to establish alternative building design standards for a particular project. The design objectives of the section should be considered as additional review criteria in the Planned Development Process.

6.7.6 Site Screening

Any delivery and service areas, external support equipment, site utility areas, or other similar high-impact elements of site and building design shall be subject to the following:

- a. All delivery or service areas and loading docks shall be located on a discrete façade, and internal to the block wherever possible.
- b. Any rooftop equipment shall be screened from view of the adjacent public streetscape or other public or common open spaces by a parapet on flat roofs, or located on a discrete pitch for pitched roofs.
- c. Any service areas, loading docks, service equipment, or other site utility area that is visible from adjacent property or public right-of-way shall be screened with a landscape buffer.
- d. Any service use that involves vehicle service bays on a primary or secondary façade shall be located on only secondary or support streets, shall have the service bay portion of the building setback at least 30’ from the lot frontage, and shall not have service bays that occupy more than 40% of a single façade.

6.7.7 Interpretation of Design Guidelines

In interpreting and applying the Small-scale Commercial and Mixed-use Design Standards, the following design guidelines shall apply. Guidelines are presented for four critical design elements of walkable Activity Centers, with an intent statement followed by the guidelines.

- a. **Streetscapes.** Streets should not only be designed to get people someplace but also be designed to be

Primary Materials	Secondary Materials	Accent / Trim Materials
Brick, unpainted (or equal or better simulated material) Stone, unpainted (or equal or better simulated material)	Any of the Primary Materials may be used as Secondary Materials	Any of the Primary or Secondary Materials may be used as an accent material
	Glass (opaque)	
	Metal Siding and Roofing	
	Color Concrete	Wood trim (or equal or better simulated material)
	Stucco (or equal or better simulated material)	
Wood shingles (or equal or better simulated material) Vertical Wood Board and Batten (or equal or better simulated material)	Horizontal Wood Clapboard (or equal or better simulated material)	Precast stone, or wood moldings or similar architectural details (or equal or better simulated material)
	Wood shingles (or equal or better simulated material)	
	Vertical Wood Board and Batten (or equal or better simulated material)	

“someplace,” balancing the needs of multiple users of the public rights-of-way. The streetscape is the “destination” in the neighborhood center. Strategies to achieve this goal include:

- ❑ Minimize the width and number of travel lanes so that vehicle design speeds are compatible with pedestrian travel.
- ❑ Maximize the use of on-street parking on all streets. On-street parking calms traffic, buffers pedestrians from moving vehicles, gives retail uses many “priority” front-door parking spaces, and allows for more efficient development of building sites.
- ❑ Use expanded landscape and pedestrian amenity areas to transition from the on-street parking to the pedestrian areas. Amenities such as landscape beds, tree wells, benches or other street furniture should be regularly spaced in a 4 to 6 foot wide area immediately adjacent to the street edge.
- ❑ Maintain significant pedestrian areas – typically at least 6 to 10 feet in addition the landscape and pedestrian amenity areas.
- ❑ On wide sidewalks where significant areas for through pedestrian traffic remain, areas may be used for street activities related to uses in the buildings, such as sidewalk sales, outside dining or seating areas, and kiosks.
- ❑ Street trees should be densely located to provide shade for pedestrians, yet achieve canopy heights and crown heights that maintain visibility of adjacent buildings and the street level uses. Alternatively, arcades may extend over the entire sidewalk areas.
- ❑ Frequent connections to adjacent neighborhoods should provide multiple alternative routes between the neighborhood and the center.
- ❑ Curb-cuts should be limited in width, frequency, and location. Vehicular access to sites should not occur on any primary street, but be located on secondary streets or alleys. Access points should be combined and shared within blocks. Curb-cuts should always be designed to emphasize the priority of pedestrian movements along the streetscape, maintaining the grade and surface material of the sidewalk across all alley or driveway access points to the interior of the block.
- ❑ Intersections should appropriately balance vehicle turning movements and pedestrian movements.
- ❑ Techniques to slow turning movements and decrease pedestrian crossing distances, such as bump-outs or curb-projections, smaller curb radii, and pedestrian

refuge items should be incorporated into the streetscape.

- b. **Buildings.** Buildings should create a “street wall” that defines the streetscape and animates pedestrian areas with active and “permeable” transitions from the public realm to the private realm.
 - ❑ Buildings should be built to the front lot line in most circumstances and occupy a significant portion of the lot frontage.
 - ❑ All buildings should have its primary façade and primary entrance oriented toward the street.
 - ❑ Street level facades should be “permeable” to animate the public streetscape and improve the interest, comfort, and safety for pedestrians. Significant proportions of transparent display windows and door openings should occur along street fronts.
 - ❑ Upper level facades should include punched openings with transparent windows. Openings should create transparency and break up the massing of the upper facades. Each story should meet this requirement independently.
 - ❑ No long horizontal blank wall space without openings to the interior of the building should occur along street level facades.
 - ❑ Significant deviations from building alignments may occur along the street wall at limited locations along a block face. These deviations should be strategically located to emphasize and embellish important elements of the public realm and include features such as public art and water fountains.
 - ❑ Examples of significant deviations in the street wall are front entry courts for dining or building entrances, courtyards or plazas.
 - ❑ All facades shall include architectural elements such as accent banding, base plates, cornices, soffits, sills, parapets, transoms, and windows aligned horizontally. The horizontal alignment should differentiate stories in a building and create a base and crown for the building.
 - ❑ Architectural diversity and creativity should be encouraged and rewarded to avoid dull or homogeneous buildings. Buildings should incorporate elements from the vernacular of buildings in Cheyenne (Consult *PlanCheyenne*, Structure Plan Section 2 on Cheyenne’s “Regional Architecture Identity”).
- c. **Sites.** Sites should be designed to emphasize buildings and their relationship to the streetscape, rather than individual lots along a block.

- ❑ Link adjacent sites physically and perceptually, even when they are not being developed simultaneously, and maximize opportunities for multiple sites to share site design elements.
 - ❑ Primary access to most individual sites should be pedestrian oriented, with vehicle access concentrated at shared entrances, provided internal to the blocks, or at central parking facilities and on-street parking.
 - ❑ Any off-street parking should be located behind buildings out of view from public streets, wherever possible. When located on the sides of buildings, parking areas should be screened from the streetscape by a combination of ornamental walls and landscape materials, matching the design and creating a continuation of the street wall.
 - ❑ High-impact site elements, storm water facilities, storage areas, or loading areas should be limited or located and designed to minimize impact on the streetscape design. Design site utility areas to perform multiple functions wherever possible, such as parking areas designed to host occasional special events or designed with landscape and screening that infiltrates storm water.
 - ❑ Exterior lighting and signs should be provided at a pedestrian scale and should coordinate with building architecture and landscape materials.
 - ❑ Use screens and buffers only when a better site design that relates to adjacent sites, buildings, and uses is not possible.
- d. **Open Spaces.** Open spaces are valuable for their ability to enhance public life in Activity Centers, providing patrons of businesses opportunities for gathering and social interaction.
- ❑ Plazas or courtyards should be located at key focal points along the streetscape with high accessibility and visibility, and be consolidated within blocks.
 - ❑ Open spaces should be designed to provide a balance of “hardscape” for public gathering and “landscape” for ornamental purposes.
 - ❑ Open spaces should include elements of public art.
 - ❑ Any green space in the neighborhood center should be designed to serve multiple functions of storm water mitigation, recreation, aesthetic amenities, or strategic screening. Undevelopable or remnant green space is not valuable to neighborhood centers unless it serves one of these broader functions.
 - ❑ Incorporate sensitive natural areas or prominent topographic features into natural open spaces.

6.8 Large Scale Commercial Design Standards

- 6.8.1 Design Objective
- 6.8.2 Applicability
- 6.8.3 Open Space Design
- 6.8.4 Building Design
- 6.8.5 Screening and Buffering
- 6.8.6 Community Character

6.8.1 Design Objective

The Design Objective of the Large-scale Commercial Design Standards is to:

- a. Promote high quality development projects that are regionally competitive.
- b. Ensure the economic vitality of commercial development within the City and help maintain a robust tax base.
- c. Provide safe, convenient, and accessible pedestrian access to large-scale areas, and promote “park once” environments for automobile oriented centers.
- d. Reduce the massive scale and uniform, impersonal appearances of large retail buildings, and to provide visual interest that will be consistent with the community’s identity, character and scale.
- e. Provide clear, direct pedestrian connections and reduced walking distances through parking areas to building entrances and to surrounding neighborhoods, commercial areas or streets.
- f. Integrate main entrances or driveways with the surrounding street network for vehicles, pedestrians, and bicycles.
- g. Require a level of architectural character for activity centers.

6.8.2 Applicability

These standards apply to community / regional activity centers, large-scale commercial buildings, or other similar areas where larger buildings, with a large market trade area and automobile orientation can impact the community negatively unless designed in a coordinated manner. They apply in addition to any generally applicable design requirements of this Article, and the standards of Articles 4 and 5. Specifically, they apply to the following circumstances:

- a. New retail or mixed use developments that include retail, where the combined gross floor area exceeds 50,000 square feet.
- b. Existing building expansions of 20% gross floor area or 20,000 square feet when the resulting development size is

more than 50,000 square feet.

- c. Updates to the exteriors of existing buildings in large commercial developments that do not meet sub-sections a. or b. shall meet the intent of the standards in this Section to the extent feasible.
- d. These standards shall not be construed to necessitate improvements to existing buildings or site conditions beyond those necessary to integrate the proposed improvement with the existing conditions in a manner consistent with these standards.

6.8.3 Open Space Design

Where site development occurs without subdivision of land, and where the lot does not have access to the Civic Open Space system required by the Subdivision Regulations, open space shall be provided on the lot subject to the following:

- a. On-site open space shall be 8% of the building footprint plus an additional 1% for each story of the building greater than 2 stories.
- b. On-site open space shall meet the Type and Design Standards of Article 4, Section 4.4 of the Subdivision Standards, and located as an extension of the public streetscape, and Internal Access Street, or other Civic Open Spaces in the commercial or mixed-use center.
- c. Areas of the right-of-way or any Internal Access Streets that permit enhanced designs beyond the basic street standards, and which also meet the requirements for one of the Civic Open Space types in Section 4.4, may contribute to required open space.

6.8.4 Building Design

- a. **Facades and Exterior Walls.** Facades will be articulated to reduce the massive scale and uniform, impersonal appearances of large retail buildings, and to provide visual interest that will be consistent with the community’s identity, character and scale.
 - 1. Facades greater than 100’ in length, measured horizontally, shall incorporate wall plane projections or recesses having a depth of at least 3% of the length of the facade and extending at least 20% of the length of the facade. No uninterrupted length of any facade shall exceed 100 horizontal feet.
 - 2. Exterior walls that face public streets shall have arcades, display windows, entry areas, awnings or other such features along no less than 60% of its horizontal length.
- b. **Detail Features.** At least one of following elements 1, 2 or 3 shall repeat horizontally and all elements used shall repeat at intervals of no more than 30’ either horizontally

or vertically. All building facades shall include a repeating pattern that contains not less than three of the following elements:

1. Color change;
2. Texture change;
3. Material module change; or
4. An expression of architectural or structural bays through a change in plane no less than 12 inches in width, such as an offset, reveal or projecting rib.

c. **Roofs.**

1. *Flat Roofs.* Flat roofs or any roof with a pitch less than 2:12 shall have parapets concealing flat roofs and rooftop equipment from public view. The average height of such parapets shall not exceed 15% of the height of the supporting wall and such parapets shall not at any point exceed one-third of the height of the supporting wall. Such parapets shall feature three-dimensional cornice treatment.
2. *Pitched Roofs.* Pitched roofs with a slope over 2:12 shall have no less than two of the following features:
 - (a) Overhanging eaves, extending no less than 3' past the supporting walls;
 - (b) Sloping roofs that do not exceed the average height of the supporting walls, with an average slope greater than or equal to 1' of vertical rise for every 3' of horizontal run and less than or equal to 1' of vertical rise for every 1' of horizontal run; and
 - (c) Three or more roof slope planes.

d. **Materials and Colors.** Building materials and colors shall comply with the following:

1. Predominant exterior building materials shall be high quality materials, including, but not limited to, brick, sandstone, native stone, manufactured stone and tinted/textured concrete masonry units.
2. Facade colors shall be low reflectance, subtle, neutral or earth tone colors. The use of high-intensity colors, metallic colors, black or fluorescent colors shall be prohibited.
3. Building trim and accent areas may feature brighter colors, including primary colors, but neon tubing shall not be an acceptable feature for building trim or accent areas.
4. Exterior building materials shall not include smooth-faced concrete block. When concrete panels or prefabricated metal panels are visible on building facades they must be textured and colored or otherwise incorporated in a manner consistent with

the intent of this Article. Metal panels may be used on roofs, awnings or similar features when incorporated into an architectural design consistent with the intent of this Article.

e. **Entryways.** Principal buildings in large commercial developments, where possible, shall provide multiple entrances. Multiple entrances reduce walking distances from cars, facilitate pedestrian and bicycle access from public sidewalks and provide convenience where certain entrances offer access to individual stores or identified departments of a store. Multiple entrances also mitigate the effect of unbroken walls and neglected areas that often characterize building facades that face other properties.

1. *Two Entryways.* At least two distinct entryways are required on any front facades over 250' in length proposed to accommodate customer entryways. Customer entryways shall be placed in a manner that best accommodates pedestrian, bicycle and traffic flows and mitigates the effects of unbroken walls.
2. *Design Elements.* Customer entryway design elements and variations should give orientation and aesthetically pleasing character to the building.
 - (a) The following standards identify desirable customer entryway design features. Each principal building on a site shall have clearly defined, highly visible customer entrances featuring not less than three of the following:
 - (1) Canopies or porticos;
 - (2) Overhangs;
 - (3) Recesses/projections;
 - (4) Arcades;
 - (5) Raised corniced parapets over the door;
 - (6) Peaked roof forms;
 - (7) Arches;
 - (8) Outdoor patios;
 - (9) Display windows;
 - (10) Architectural details such as tile work and moldings which are integrated into the building structure and design;
 - (11) Integral planters or wing walls that incorporate landscaped areas and/or places for sitting.
3. *Multiple Stores.* Where additional stores will be located in a large retail structure, each such store shall have at least one exterior customer entrance, which shall conform to the above requirements.

- f. **Alternatives.** Minor deviations from these standards may be evaluated by the Director in accordance with the process and procedures for an Administrative Adjustment as described in Article 2. In addition to the review criteria described in Article 2 the Director shall also evaluate the proposal using the design objectives of the section as additional criteria. Where a proposal offers a unique building design that is not accommodated by minor adjustments as described above, then the process and procured for a Planned Development in Article 2 may be followed to establish alternative building design standards for a particular project. The design objectives of the section should be considered as additional review criteria in the Planned Development Process.

6.8.5 Screening and Buffering

Screening of utilities, maintenance areas and service areas from public view must be provided using landscaping or architectural elements that are integrated into the building's architecture subject to the following minimum requirements:

- a. Outdoor storage, trash collection and/or compaction, loading or other such uses shall be located in the rear of the lot. If because of lot configuration the Director determines that such placement is not feasible, then the side yard may be used, but in no case shall such area(s) be located within 20' of any on-site pedestrian way or within the setback area.
- b. Outdoor storage, HVAC equipment, trash collection, trash compaction and other service functions shall be incorporated into the overall site design. Views of these areas shall be screened with solid material from visibility from all property lines and streets and separated from sidewalks and on-site pedestrian ways. Screening structures shall be made of the same materials as the principal structure.
- c. Non-enclosed areas for the storage and sale of seasonal merchandise shall be permanently defined and screened with walls and/or fences. Materials, colors and design of screening walls and/or fences shall conform to those used as in the principal structure. If such areas are to be covered, then the covering shall conform to the colors on the building.
- d. Outdoor display and storage shall not encroach on any portion of a walkway, drive aisles, required parking spaces or landscape area.

6.8.6 Community Character

Applicants for projects subject to the requirements of this Article shall submit a statement of authenticity, describing how the proposed design responds to Cheyenne's regional architectural identity. Using the PlanCheyenne Community Design Handbook as a reference, applicants shall present information regarding the architectural precedents which support their proposed design and a brief statement on how the proposed project enhances Cheyenne's unique identity.

6.9 General Commercial Design Standards

- 6.9.1 Design Objective
- 6.9.2 Applicability
- 6.9.3 Open Space Design
- 6.9.4 Building Design
- 6.9.5 Screening and Buffering

6.9.1 Design Objective

The Design Objective of the General Commercial Design Standards is to:

- a. Use quality building and site design to increase the community's awareness of quality design and its contributions to our quality of life and image.
- b. Use quality building and site design to enhance and protect the public realm including public streets, internal access ways and Civic Open Spaces.
- c. Reduce the massive scale and uniform, impersonal appearances of large buildings, and to provide visual interest that will be consistent with the community's identity, character and scale.
- d. Require a level of architectural character for activity centers.
- e. Encourage quality construction and improve sustainability with durable, adaptable, and re-usable buildings.

6.9.2 Applicability

These standards apply to community / regional activity centers, commercial buildings, or other similar areas where commercial buildings, with automobile orientation can impact the community negatively unless designed in a coordinated manner. They apply in addition to any generally applicable design requirements of this Article, and the standards of Articles 4 and 5. Specifically, they apply to new construction and additions to buildings in the following zone district:

- a. CB
- b. SS
- c. BP, for non-industrial development

6.9.3 Open Space Design

Where site development occurs without subdivision of land, and where the lot does not have access to the Civic Open Space system required by the Subdivision Regulations, open space shall be provided on the lot subject to the following:

- a. On-site open space shall be 2% of the building footprint for lots 2,500 square feet or less; 5% of building footprint for lots over 2,500 square feet and under 40,000 square feet; and 8% of the building footprint for lots 40,000 square feet or more.
- b. On-site open space shall meet the Type and Design Standards of Article 4, Section 4.4 of the Subdivision Standards, and located as an extension of the public streetscape, and Internal Access Street, or other Civic Open Spaces in the commercial or mixed-use center.
- c. Areas of the right-of-way or any Internal Access Streets that permit enhanced designs beyond the basic street standards, and which also meet the requirements for one of the Civic Open Space types in Section 4.4, may contribute to required open space.

6.9.4 Building Design

All buildings shall include the following elements:

- a. **Entryways.** Each public entryway shall have clearly defined, highly visible entrances featuring not less than three of the following:
 - 1. Canopies or porticos;
 - 2. Overhangs;
 - 3. Recesses/projections;
 - 4. Arcades;
 - 5. Raised corniced parapets over the door;
 - 6. Peaked roof forms;
 - 7. Arches;
 - 8. Outdoor patios;
 - 9. Display windows;
 - 10. Architectural details such as tile work and moldings which are integrated into the building structure and design;
 - 11. Integral planters or wing walls that incorporate landscaped areas and/or places for sitting.

b. **Roofs/Top.**

1. *Top.* The top of buildings shall be the upper most 5% to 25% of the façade and shall be differentiated with a continuous horizontal architectural treatment such as a cornice or parapet line. Except that on pitched roof structures, the eave and roof structure shall be the top. Differentiation of the top of the building is not required on buildings of three stories or more, using over 90% primary materials (excluding Concrete Masonry Units), provided the building includes three or more window openings on each floor on all facades.
2. *Flat Roofs.* Flat roofs or any roof with a pitch less than 2:12 shall have parapets concealing flat roofs and rooftop equipment from view of adjacent public streets, internal Access ways and Civic Open Spaces.
3. *Pitched Roofs.* Pitched roofs with a slope over 2:12 shall have no less than two of the following features:
 - (a) Overhanging eaves, extending no less than 3' past the supporting walls;
 - (b) Sloping roofs that do not exceed the average height of the supporting walls, with an average slope greater than or equal to 1' of vertical rise for every 3' of horizontal run and less than or equal to 1' of vertical rise for every 1' of horizontal run; and
 - (c) Three or more roof slope planes.

c. **Facades and Exterior Walls.** Any façade that faces a public street including Interstates, Internal Access Ways, or Civic Open Space shall contain the following façade design features:

1. Facades greater than 100' in length, measured horizontally, shall incorporate wall plane projections or recesses having a depth of 3' to 10' and extending at least 20% of the length of the facade. No uninterrupted length of any façade shall exceed 100 horizontal feet.
2. Arcades, display windows, entry areas, awnings or other such features along no less than 60% of its horizontal length.

d. **Detail Features.** All building facades shall include a repeating pattern that contains not less than three of the following elements:

1. Color change;
2. Texture change;
3. Material module change; or
4. An expression of architectural or structural bays through a change in plane no less than 12 inches in width, such as an off set, reveal or projecting rib.

Note: At least one of elements 1, 2 or 3 shall repeat horizontally. All elements used shall repeat at intervals of no more than 30', either horizontally or vertically.

e. **Building Materials.** All buildings and accessory buildings over 200 square feet shall be constructed according to the following material standards. Percentage requirements for materials exclude windows or other openings. Carports, stand-alone canopies, or other structures which only consist of vertical support posts in the area between 2' and 8' above grade and are less than 2 stories in height shall be exempt from the materials requirements of this section.

1. *Primary Materials.* All buildings shall have one primary material covering at least 30% of the building facades. Buildings which are more than 50% residential dwelling units (by square footage) may use any of the Secondary Materials as a primary material provided:
 - (a) No less than 2 primary/secondary materials are used;
 - (b) No one primary/secondary material covers more than 70% of the facades; and
 - (c) No one color covers more than 70% of the facades (colors shall be distinctly different, if there is a debate over whether the proposed colors are distinctly different, an applicant may appeal the Director's determination to the Board of Adjustment).
2. *Secondary Materials.* Buildings may have a secondary material covering up to 70% of the façades.
3. *Accent Materials.* Buildings shall have at least one, and may have up to two accent or trim materials covering between 5% and 10% of the building facades. The accent shall be a separate material from the primary materials utilized on the building.
4. *Permitted Materials.* Exterior materials shall be permitted in accordance with Table 6-21.

TABLE 6-21: GENERAL COMMERCIAL AND MIXED-USE BUILDING MATERIALS

<i>Primary Materials</i>	<i>Secondary Materials</i>	<i>Accent / Trim Materials</i>
Brick, unpainted (or equal or better simulated material)	Any of the Primary Materials may be used as Secondary Materials	Any of the Primary or Secondary Materials may be used as an accent material
	Glass (opaque)	
	Metal Siding and Roofing	
	Architectural Metal Panels or Tiles	
Stone, unpainted (or equal or better simulated material).	Color Concrete	Wood trim (or equal or better simulated material)
	Horizontal Wood Clapboard (or equal or better simulated material)	
Concrete Masonry Unit – Integrally tinted and textured	Wood shingles (or equal or better simulated material)	Precast stone, or wood moldings or similar architectural details (or equal or better simulated material)
	Stucco (or equal or better simulated material)	
	Vertical Wood Board and Batten (or equal or better simulated material)	

5. *Material Changes.* Except for accent materials, changes in the façade material shall only occur at horizontal expression lines. Alternatively, changes in the material may occur at differentiated structural bays that meet the horizontal massing requirements above.
6. *Equal or Better Simulated Materials.* Where “equal or better” simulated materials are permitted, they shall only be permitted by the Director as an Administrative Adjustment according to procedures and criteria in Article 2. The Director shall use the following additional criteria:
 - (a) The proposed material has an identical physical appearance as the material it intended to simulate, including color and texture, as perceived from any public spaces surrounding the property;
 - (b) The material presents benefits in addition to cost savings, such as reduced maintenance, or enhanced durability and performance;
 - (c) The material has a demonstrated track record of successful application and use that will result in equally long-lasting and sustainable appeal of the

neighborhood as that of the permitted materials; and

- (d) Use of equal or better materials may be conditioned upon compliance with all application and manufacturer specifications.

- f. **Alternatives.** Minor deviations from these standards may be evaluated by the Director in accordance with the process and procedures for an Administrative Adjustment as described in Article 2. In addition to the review criteria described in Article 2 the Director shall also evaluate the proposal using the design objectives of the section as additional criteria. Where a proposal offers a unique building design that is not accommodated by minor adjustments as described above, then the process and procured for a Planned Development in Article 2 may be followed to establish alternative building design standards for a particular project. The design objectives of the section should be considered as additional review criteria in the Planned Development Process.

6.9.5 Screening and Buffering

Screening of utilities, maintenance areas and service areas from view of adjacent public streetscape must be provided using landscaping or architectural elements that are integrated into the building’s architecture subject to the following minimum requirements:

- a. Outdoor storage, trash collection and/or compaction, loading or other such uses shall be located in the rear of the lot. If because of lot configuration the Director determines that such placement is not feasible then the side yard may be used.
- b. Outdoor storage, HVAC equipment, trash collection, trash compaction and other service functions shall be incorporated into the overall site design. Views of these areas shall be screened with solid material from visibility from all property lines and streets and separated from sidewalks and on-site pedestrian ways. Screening structures shall be made of the same materials as the principal structure if not placed behind the building.
- c. Outdoor display and storage shall not encroach on any portion of a walkway, drive aisles, required parking spaces or landscape area unless otherwise authorized by this code.

ARTICLE 7 FORM-BASED CODES

7

Article 7, Form-Based Codes provides an alternative process and standards for doing master planned developments. It includes standards that replace or supplement subdivision standards, zoning standards, and design standards in relation to a specific and detailed area plan. It is most useful to developers and landowners who want to develop walkable activity centers and neighborhoods.

UNIFIED DEVELOPMENT CODE

ARTICLE 7 FORM-BASED CODES

- 7.1 General Provisions
- 7.2 Planning and Community Design Standards
- 7.3 Lot and Building Type Standards
- 7.4 Use Standards
- 7.5 Site and Building Standards

7.1 GENERAL PROVISIONS

- 7.1.1 Intent
- 7.1.2 Applicability
- 7.1.3 Planned Zoning

7.1.1 Intent

This Article establishes standards and a process to develop innovative mixed-use development as an alternative to that permitted by the standard provisions of other Articles in the Unified Development Code, through comprehensive and specific area plans. Specifically, a Form-Based Code is an alternative option for planning, regulating and developing property that:

- a. Creates a dynamic, mixed-use environment, where walking is the preferred mode of transportation.
- b. Provides for a range of housing choices in close proximity to each other, including vertical mixed-use.
- c. Creates land development solutions unique to a specific development site and based upon a specific area plan.
- d. Produces quality public spaces that are usable for a variety of public and semi-public activities.
- e. Ensures higher standards of design and construction for buildings, public infrastructure, and landscaping, emphasizing the relationships of buildings and the spaces between buildings.
- f. Guarantees a high degree of connectivity for pedestrian and vehicular traffic, and supports potential transit service.
- g. Locates buildings close to the street, so that streets and squares are defined as "outdoor rooms".
- h. Utilizes all the streets for on-street parking.
- i. Provides numerous, narrow, slow-speed streets to ensure

the safety of pedestrians and bicyclists.

- j. Expedites the development process in exchange for the prerequisite of comprehensive planning and urban design.

7.1.2 Applicability

This alternative process for planning, regulating and developing property is most applicable where walkable, mixed-use neighborhoods are a desired result, and specifically for the Activity Center areas designated in the Comprehensive Plan. It is a more comprehensive alternative to a PUD or an option for infill areas where scale and urban design is emphasized over the specific use of lots and buildings.

- a. **Conceptual Framework & T-Zones.** Because of the unique characteristics of mixed-use areas and the Activity Centers in the Comprehensive Plan, a sub-classification of organizing property and uses is established. The sub-classifications used to plan, regulate and develop the built environment in form-based codes are called "Transect Zones" (T-Zones). T-Zones utilize land use, density, and intensity to create a quality environment by specifying how they are assets to the community, rather than regulating them as potential detriments to the development. Not all T-Zones may be applicable to all regulating plans. T-Zone definitions are as follows:

1. T-1 Natural: Land that will permanently remain undeveloped due to significant natural or environmental features.
2. T-2 Rural/Reserve: Undeveloped or rural and estate areas, either held for future growth or used for ecological and agricultural support of other T-Zones.
3. T-3 Suburban: The least densely developed area and predominantly residential context of a community, and exists only in support of other closely associated and higher level T-Zones.
4. T-4 General Urban: A dense residential context, typically the largest zone within a community. It allows for the widest variety of housing choice, but a mix of small-scale commercial uses may be located at key intersections or along significant corridors.
5. T-5 Urban Center: A dense, mixed-use context, typically

located near the center of a Pedestrian Shed or as a corridor along important thoroughfares.

6. T-6 Urban Core: The most dense, primarily mixed-use business, cultural and entertainment concentration of a region, typically assigned to major crossroads.
 7. D District: Specialized single-use sections of a community that have a regional scale or which serve important support functions for other T-Zones but cannot achieve the scale, form and urban design of those zones. Examples are hospitals, universities, stadiums or event centers, intensive employment facilities (i.e. manufacturing, warehousing, or wholesale).
 8. CS Civic Space: Sites reserved for Civic Buildings and Civic Open Space. Zone CS includes land reserved for parks.
- b. **District Size.** The overall area subject to a Regulating Plan for a Form-Based Code shall be at least 20 acres, but can be smaller for additions to an existing Regulating Plan or for infill areas where the context provides an existing Pedestrian Shed in the immediately abutting areas.
- c. **Regulating Plan Criteria.** All regulating plans shall be evaluated on the following specific criteria, in addition to the general purposes and intent of this code:
1. The plan consists of one or a series of neighborhoods of an approximately ¼ mile, but never greater than ½ mile radius, which correlates to a 5 to 10 minute walk from centers to edges.
 2. Each neighborhood has a discernible center, offering a wide variety of daily needs and services for the neighborhood.
 3. Each neighborhood has a variety of dwelling types.
 4. All regulating plans of 80 acres or more allow civic uses within the neighborhood centers.
 5. Each neighborhood has a variety of open spaces.
 6. The development has streets laid out in a connected network, so there are multiple alternate routes to various destinations.
 7. Building and lot designs prioritize the relationship to the public realm – the streets and open spaces of the plan – resulting in “outdoor rooms.”
 8. Street designs accommodate parking. Parking lots and garages rarely front the streets, and are typically relegated to the rear of the lot.
 9. All regulating plans of 80 acres or more include a minimum of 3 out of the 6 T-Zones excluding Zones

T-1, D, and CS.

10. T-Zones within the plan are arranged in succession (T-3, T-4, T-5 etc.), but may skip one zone. In no case may abutting T-Zones skip over more than one zone (example T-2 to T-5). Zones D and CS do not occur in succession and may abut any other T-Zone.

7.1.3 Planned Zoning

Form-Based Codes are a planned zoning district that involves the submittal and approval of a Regulating Plan / Master Development Plan at the time of the proposed rezoning. In addition to any procedures and submittal requirements authorized by Article 2, proposed Form-Based Codes shall include the following components:

- a. **Conceptual / Illustrative Plan.** Narrative, maps, and illustrations demonstrating:
 1. the vision and project summary;
 2. an analysis of existing conditions on the site and surrounding areas;
 3. general development concepts and master plan for the site;
 4. general character and special features of the plan and distinct areas within the plan, including at least one perspective illustration for each T-Zone indicating a typical arrangement and application of all of the proposed standards upon final execution of the development;
 5. preliminary utility, grading and other construction-related plans, including any phasing proposed for development;
 6. the pedestrian shed(s) that represent the fundamental planning unit(s) for the development, demonstrating the activity centers for the neighborhood and those areas within a 5 to 10 minute walk of those centers on existing or planned pedestrian routes; and
 7. the process by which the vision and concepts were arrived at, including any specific stakeholder outreach that was conducted in addition to those procedures required by Article 2 for a Regulating Plan / Master Development Plan.
- b. **Regulating Plan.** A plan designating the street network, block or development pattern and relation to surrounding areas, and including blocks or locations within the plan where different form standards will apply (T-Zones). The Regulating Plan and proposed T-Zones establish

the planned zoning upon approval. At a minimum, the Regulating Plan shall include:

1. a plan that illustrates the location of the T-Zones contained in the project;
 2. perspective illustrations of the building types contained in the project and which T-Zones they are allowed in;
 3. illustrations of parks, open space, including specific locations of various types on the Regulating Plan, including at least one perspective illustration of each open space type;
 4. a plan for the street network and illustrated thoroughfare standards including at least one perspective and one plan view illustration of each thoroughfare type, indicating their applicability to specific blocks within the street network; and
 5. a building and unit count, indicating the range of units and range of building types permitted on a block-by-block basis.
- c. **Building and Site Form Standards.** Blocks and locations within the Regulating Plan (T-Zones) shall be subject to regulations that apply to specific building types and sites according to this Article, or where they differ from the standards in this Article the specific purpose and parameters for the differences shall be identified in the Form Standards proposed with a Regulating Plan.
- d. **Design Manual (optional).** A wide variety of uses and structures are permitted under a Form-Based Code. To encourage this, and to ensure that this occurs with a compatible design that can endure through potential adjustments over time, basic design standards are associated with rezoning under a Form-Based Code. Any standards specific to a particular Regulating Plan that are proposed to adjust or supplement the standards in this Article may be included in association with a Regulating Plan and Building and Site Form Standards. These may include specific building, site, sign, landscape, thoroughfare, open space, or architectural standards for the plan.
- e. **Performance Standards (optional).** To meet the Intent section of this Article, T-Zones allow for a mixture of uses, often adjacent to or very close to each other. Issues of noise, trash, and operational hours are to be closely coordinated. In order to coordinate long-term performance of various uses under the plan, and rather than preventing anticipated or assumed future issues by simply prohibiting
- broad classes of uses, Form-Based Codes should address this issue through on-going management, operations and performance measures associated with the mixture of uses. Standards based on the operations and management of specific uses, or additional limitations or conditions on uses, may be included as part of the Form-Based Code or as part of covenants and restrictions associated with the property.
- f. **Administration.** The plan shall include a section for administration of development upon approval of the Regulating Plan. The Regulating Plan may propose specific parameters, criteria and procedures for executing development according to the plan. Each plan may also propose a special development review board, however at a minimum development according to an approved Regulating Plan shall follow the procedures and criteria for City review in Article 2. These include:
1. The Staff is delegated the authority to approve the final site plan for all development that is in conformance with the approved Regulating Plan and administrative plats that are in conformance with an approved Final Plat.
 2. If the Staff does not approve a final site plan, specific reasons for the disapproval, based on standards of the Regulating Plan shall be given and the issue will be presented to the planning commission as an amendment to a planned development according to the initial procedures and criteria for a planned development established in Article 2.

7.2 PLANNING AND COMMUNITY DESIGN STANDARDS

- 7.2.1 Community Design Elements - Generally
- 7.2.2 Transportation Networks and Street Designs
- 7.2.3 Blocks and Lots
- 7.2.4 Civic Open Space Systems

7.2.1 Community Design Elements - Generally

All Regulating Plans shall be based on coordination the following basic community design elements throughout the plan and which are necessary to integrate complete communities at the neighborhood scale or greater (See Section 4.1.3 of Article 4):

- a. Transportation Networks and Street Designs
- b. Blocks and Lots
- c. Open Space Systems

7.2.2 Transportation Networks and Street Designs

In general, Regulating Plans shall be based on a highly connected street network that accommodates a greater variety of street designs and slower design speeds, to ensure the safety of pedestrians, bicyclists, and motorists. This entails narrower lane widths, the provision of on-street parking on all street types, and small curb radii at intersections. Street design types shall be based on the Context-based Street Design Types in Article 4 (Table 4-7 and applicable cross sections) and allocated to the Regulating Plan based on T-Zones according to Table 7-1:

Building Type	T1	T2	T3	T4	T5	T6	CS	D
Rural Road	■	■					■	
Neighborhood Street (A-C)			■	■	■	■	■	■
Street			■	■	■	■	■	■
Parkway			■	■	■		■	■
Avenue			■	■	■	■	■	■
Boulevard				■	■	■	■	■
Trafficway				■	■			■
Alley			■	■	■	■	■	■

7.2.3 Blocks and Lots

The Regulating Plan and Transportation Network Plan shall organize the area into block and lot patterns according to

T-Zones. The maximum block size shall be according to Table 7-2.

T-Zone	Maximum Perimeter	Maximum per Block Face
T1	No maximum	No maximum
T2	No maximum	No maximum
T3	1980'	660'
T4	1980'	660'
T5	1300'	400'
T6	1300'	400'
CS	Based on most closely associated T-Zone in the plan, but may vary subject to specific plan approval	
D	Based on most closely associated T-Zone in the plan, but may vary subject to specific plan approval	

Exceptions to these standards shall only be authorized in an approved Regulating Plan subject to the criteria established in Section 4.3.3.

7.2.4 Civic Open Space Systems

The Regulating Plan shall include an allocation of civic open space for each T-Zone based on the Open Space Design Types in Article 4, Section 4.4. The types of permitted open space shall be based on the planning and design standards in Article 4, with the specific types permitted in each T-Zone according to Table 7-3.

Open Space Design Type	T1	T2	T3	T4	T5	T6	CS	D
Natural Area	■	■	■				■	■
Trail Corridor	■	■	■	■			■	■
Community / Regional Park		■	■	■			■	■
Neighborhood Park			■	■	■		■	■
Green			■	■	■		■	■
Plaza				■	■	■	■	■
Courtyard / Patio				■	■	■	■	■
Pocket Park / Gateway			■	■	■	■	■	■

7.3 LOT AND BUILDING TYPE STANDARDS

- 7.3.1 Building Types
- 7.3.2 Frontage Types
- 7.3.3 Setback Standards
- 7.3.4 Height Standards
- 7.3.5 Lot Size and Standards

7.3.1 Building Types

Each Form-Based Code shall allow a variety of Building Types, specified below.

a. **Building Type Descriptions.**

1. *House (Type I).* A detached building designed as a single dwelling unit and situated on its own fee simple lot.
2. *Duplex (Type II).* A detached building designed as two dwelling units. It may be designed as a “paired house,” matching the appearance of a House, or it may be designed as a “flat-over-flat,” matching the appearance of a small apartment building. A duplex is situated on its own fee simple lot, but each unit of a side-by-side

paired house may be platted on an individual lot if party walls are used.

3. *Townhouse (Type III).* A building designed with a series of attached dwelling units separated by a single common wall. Each unit is typically situated on its own fee simple lot where party walls are used, but buildings or grounds may be owned in common.
4. *Apartment (Type IV).* A building designed for more than two dwelling units and situated on a single fee simple lot. This building type includes a variety of variations based on scale, including “stacked flats” (3-story), “six-plex” (paired stacked flats), or larger apartments. This building type may also be designed for lodging purposes in non-residential contexts.
5. *Accessory Building (Type V).* A small detached building that is subordinate and customarily incidentally to a principle building and located on the same lot. Accessory buildings may be designed for accessory dwellings, home occupations, garages or storage associated with the principle use of the lot.
6. *Live/Work Building (Type VI).* A small mixed-use building designed for both residential and a commercial function. The building is situated on its own fee simple lot but may be attached or detached.



House (Type I)



Townhouse (Type III)



Accessory Building (Type V)



Duplex (Type II)



Apartment (Type IV)



Live / Work Building (Type VI)

7. *Small Civic Building (Type VII)*. A small detached building designed for civic uses and situated on a lot or block that serves as a focal point for the surrounding area, through building, site, and open space design within the surrounding block structure. Examples include a neighborhood school, police or fire sub-station, neighborhood center or similar buildings.
8. *Prominent Civic Building (Type VIII)*. A large detached building designed for civic uses and situated on a lot or block that serves as a focal point for the surrounding area, through building, site, and open space design that may disrupt the surrounding block structure or development pattern. Examples include a large regional school, prominent public or government building, or major community event facility
9. *Small Commercial Building (Type IX)*. A small free-standing building designed for non-residential function and situated on its own fee simple lot.
10. *Mixed-Use Building (Type X)*. A building designed for a mix of uses with office or retail on the 1st story / street-front and residential, office, lodging, or storage on the upper stories. Mixed-use buildings typically being broken into multiple fee simple lots with party walls.

b. **Allowed Building Types.** Building Types are regulated by T-Zone as listed in Table 7-4. Building types allowed by conditional approval must be approved by the Planning Commission and City Council in the original Regulating Plan, or by the Board if constructed subsequently according to Conditional Approval procedures in Article 2.

Building Type	T1	T2	T3	T4	T5	T6	CS	D
Type I: House	P	P	P	P				
Type II: Duplex			P	P				
Type III: Townhouse			C	P	P	P		
Type IV: Apartment			C	P	P	P		
Type V: Accessory Building	P	P	P	P	P	P		
Type VI: Live / Work Building			C	P	P	P		
Type VII: Small Civic Building			C	C	P	P		
Type VIII: Prominent Civic Building					C	C	P	
Type IX: Small Commercial Building				C	P	P		
Type X: Mixed-use Building				C	P	P		

"P" = permitted by right

"C" = permitted after conditional and discretionary review

In addition, proposed individual Regulating Plans may further designate the T3 and T4 zones as -R ("restricted"), -L ("limited"), or -O ("open") to further refine the types and intensity of building types within that zone as either permitted, administrative, or conditionally approved.



Small Civic Building (Type VII)

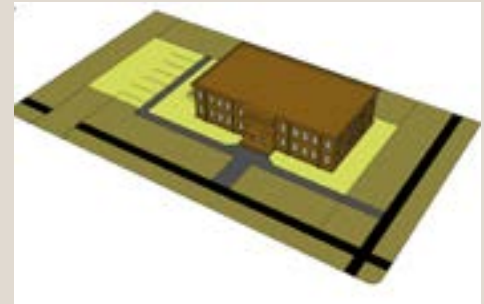

Prominent Civic Building (Type VIII)



Small Commercial Building (Type IX)



Mixed-Use Building (Type X)

7.3.2 Frontage Types

Building location and orientation in form-based codes are regulated by building type and T-Zones to create a consistent scale and relationship among a variety of buildings and uses. Therefore, a building may use a different frontage type based on the context. Each form-based code shall allow a variety of Frontage Types, specified below or identified in the form standards proposed with a regulating plan where the specific purpose and parameters for the differences shall be identified.

a. Frontage Type Descriptions.

1. *Front Yard (Type A)*. A frontage where the façade is set back from the frontage line for a formal lawn or informal landscape area, with an attached porch, stoop, or portico associated with the primary entrance permitted to encroach into the yard and emphasize the pedestrian scale of the building and streetscape.
2. *Common Lawn (Type B)*. A frontage where a group of buildings share a common lawn. The frontage has a visual relation to the street and to the buildings across the lawn. The common lawn created may suitable for limited vehicular access when it can be designed with minimal visual impact on the streetscape and is subordinate to pedestrian access and use of the common lawn.
3. *Dooryard (Type C)*. A frontage where the façade is set back from the frontage line by an at-grade courtyard. This type buffers residential use from urban sidewalks and removes the private yard from public encroachment. The dooryard is suitable for a small yard, garden or patio for residential buildings, or a more formal courtyard or plaza for non-residential buildings.
4. *Forecourt (Type D)*. A frontage where a portion of the façade is close to the frontage line and the central portion is set back with the primary entrance off of the formal courtyard. The forecourt created may suitable for limited vehicular access when it can be designed with minimal visual impact on the streetscape and is subordinate to pedestrian access and use of the forecourt.
5. *Terrace or Light Court (Type E)*. A frontage where the façade is set back from the frontage line by an elevated terrace or sunken light court. The sunken court can potentially access an additional unit below grade. This type buffers residential use from urban sidewalks and removes the private yard from public encroachment.

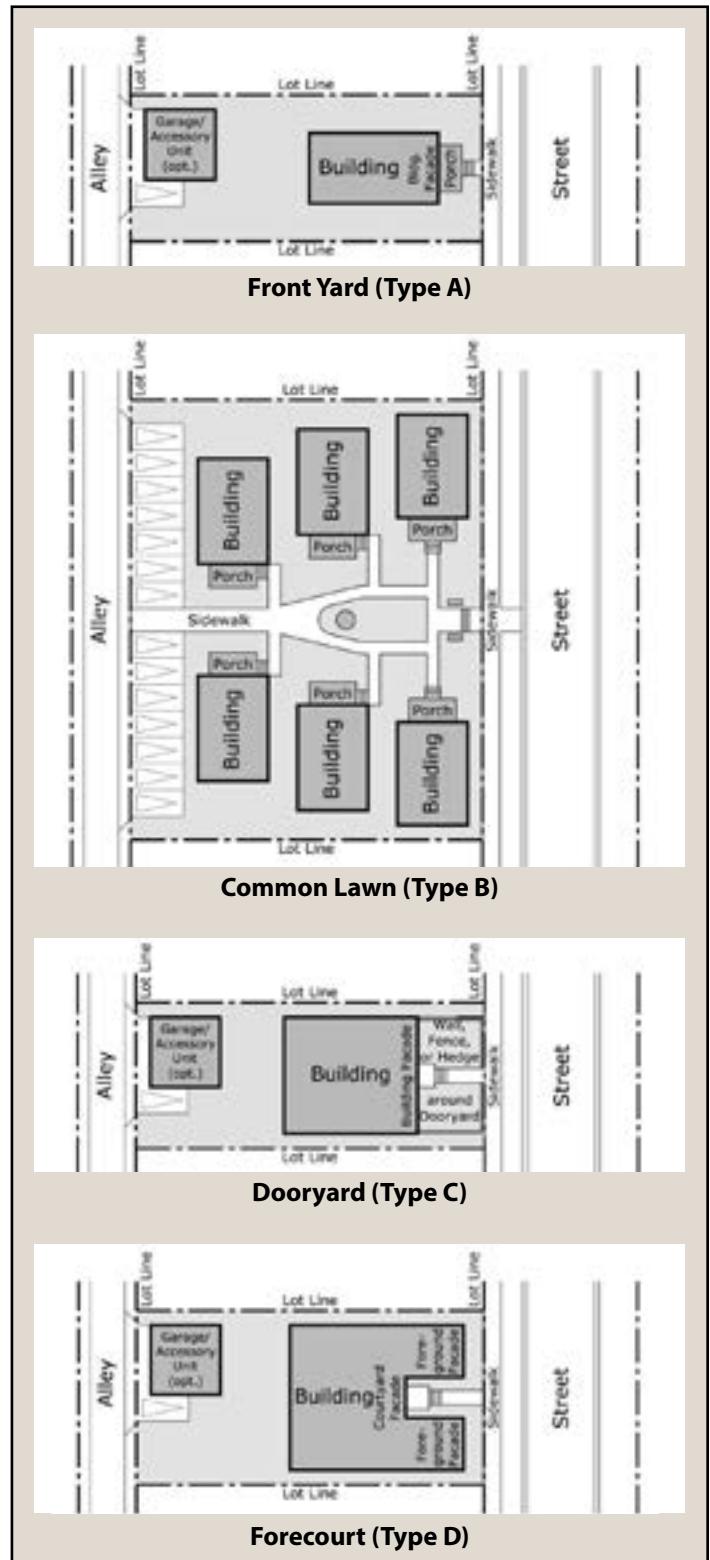

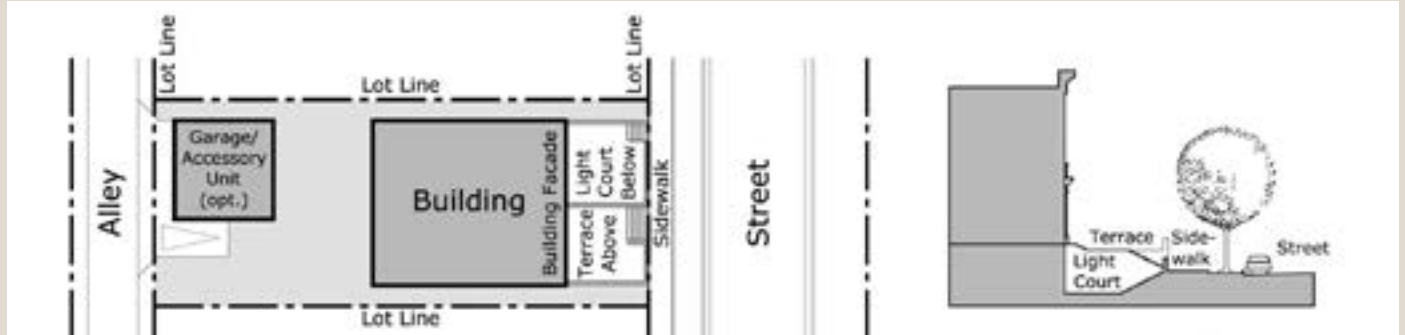

Terrace or Light Court (Type E)

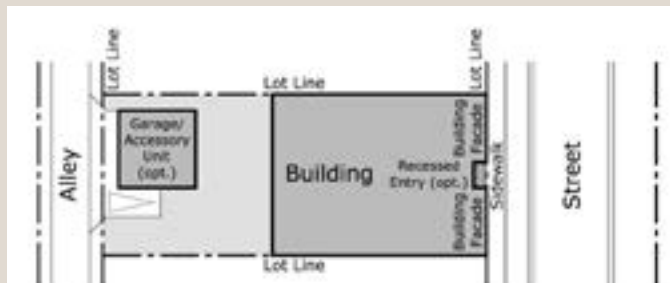

Doorway (Type F)

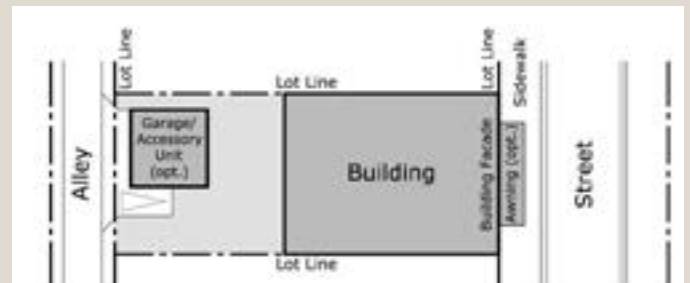

Storefront (Type G)

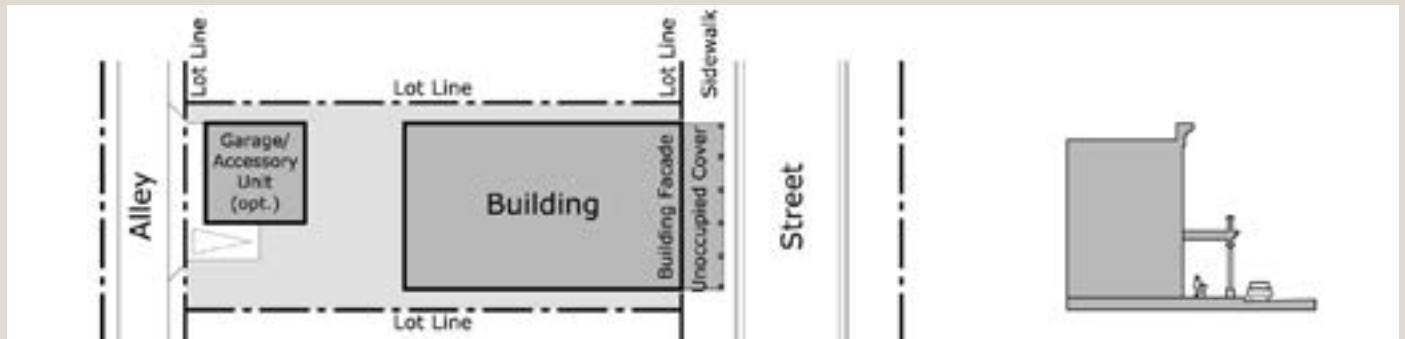

Gallery (Type H)

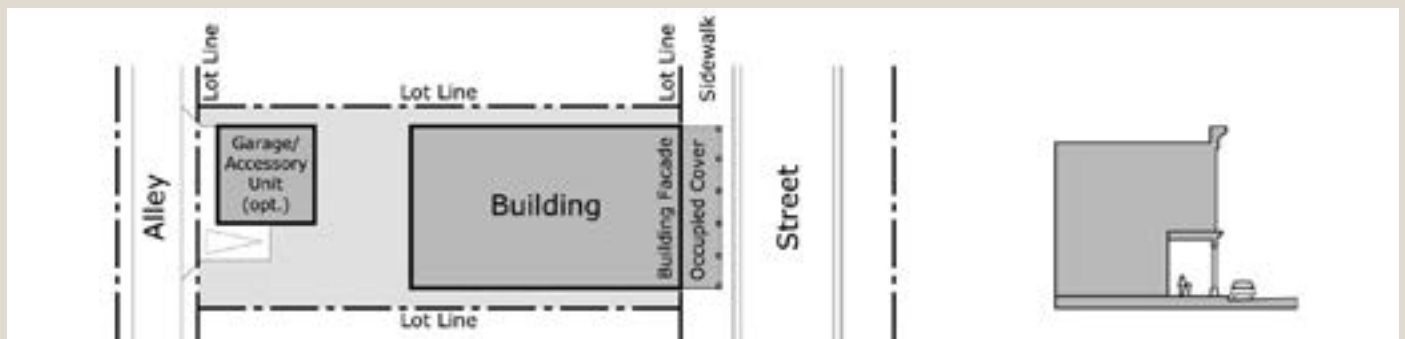

Arcade (Type I)

The terrace or light court is suitable for a small yard, garden or patio for residential buildings, or a more formal courtyard or plaza for non-residential buildings.

6. **Doorway (Type F).** A frontage where the façade is aligned with the sidewalk and the entry is a door flush with the façade, or recessed into the façade. This type is similar to Storefront frontages, except that they are primarily used for residential entries and include less transparency than a Storefront. When located within 20' of the street, the 1st story of the building is typically elevated 2' to 4' above the street grade to enhance the privacy of dwelling units on the street level.
7. **Storefront (Type G).** A frontage where the façade is aligned close to the frontage line with the building entrance at sidewalk grade. This type is conventional for retail use. It has substantial glazing on the sidewalk level and an awning that may overlap the sidewalk to the maximum extent possible.
8. **Gallery (Type H).** A frontage where the façade is aligned close to the frontage line with entrances and design details similar to a Storefront frontage and an attached cantilevered shed or a lightweight colonnade overlapping the sidewalk. This type is conventional for retail use.
9. **Arcade (Type I).** A frontage where the façade is a colonnade that overlaps the sidewalk, while the façade at sidewalk remains the frontage line with entrances and design details similar to a Storefront frontage. This type is conventional for retail use, with other uses in the occupied space above the colonnade.

b. **Allowed Frontage Types.** Frontage types are regulated by Building Type as listed in Table 7-5.

Building Type ➤	Type I: House	Type 2: Duplex	Type III: Townhouse	Type IV: Apartment	Type V: Accessory Building	Type VI: Live / work Building	Type VII: Small Civic Building	Type VIII: Prominent Civic Building	Type IX: Small Commercial Building	Type X: Mixed-Use Building
✓ Frontage Type										
Type A: Front Yard	P	P	P	P	Constraints are dependent on principle structures			By Special Review of Regulating Plan		
Type B: Common Lawn	P*	P	P	P						
Type C: Dooryard	P*	P	P	P		P	P			
Type D: Forecourt				P		P	P			
Type E: Terrace / Light Court						P	P			
Type F: Doorway						P	P			
Type G: Storefront						P			P	P
Type H: Gallery									P	P
Type I: Arcade							P	P		

P = Permitted

P* = Permitted in all applicable zones except T-2

Blank cell means type not allowed.

ARTICLE 7

FORM-BASED CODES

7.3 LOT AND BUILDING TYPE STANDARDS

7.3.3 Setback Standards

a. **Front Setbacks.** Front setbacks are regulated by T-Zone and Frontage Type according to Table 7-6.

Transect Zone ➤		T2	T3	T4	T5	T6	CS	D
Frontage Type								
Type A: Front Yard		50' min.	20-35'*	10-25'*	10-20'*	10-20'	By Special Review of Regulating Plan	
Type B: Common Lawn			10-20'*	0-10'*	0-10'*	0-10'		
Type C: Dooryard			10-20'*	5-15'*	5-15'*	5'-15'		
Type D: Forecourt	Courtyard Facade		25' min.	10-35'	10-35'	10-35'		
	Foreground Facade		10-25'*	0-10'*	0-10'*	0-10'		
Type E: Terrace/Light Court			10-25'*	8-20'*	8-20'*	8-20'		
Type F: Doorway								
Type G: Storefront			0'-5'	0'-5'	0'-5'	0'-5'		
Type H: Gallery								
Type I: Arcade								

A blank cell means that a standard is not applicable.

* indicates that a different front setback standard applies for front setbacks in existing neighborhoods; refer to section c.1. below.

b. **Side and Rear Setbacks.** Side and rear setbacks are regulated by T-Zone and Building Type according to Table 7-7.

Transect Zone ➤		T2	T3	T4	T5	T6	CS	D
Setback Type								
Type I: House		50' min.	5' min.	3-10'			By Special Review of Regulating Plan	
Type II: Duplex			5' min.	3-10'				
Type III: Townhouse			0'; 5' end unit	0'; 5' end unit	0'; 5' end unit	0'; 5' end unit		
Type IV: Apartment			5' min.	0-10'	0-10'	0-10'		
Type V: Accessory Building		Based on principle building						
Type VI: Live / Work Building				0-10'	0-10'	0-10'		
Type VII: Small Civic Building				0-10'	0-10'	0-10'		
Type VIII: Prominent Civic Building		By special review of Regulating Plan						
Type IX: Small Commercial Building				0-10'	0-10'	0-10'		
Type X: Mixed-use Building				0'; 5' end unit	0'; 5' end unit	0'; 5' end unit		
Rear Setback (all Types)	Corner Lot	50' min.	5' min.	5' min	5-10'	0-10'		
	Interior Lot	50' min.	5' min.	5' min	5' min	0-10'		
	Lot with Alley	5' exactly; or at least 16'	5' exactly; or at least 16'	5' exactly; or at least 16'	0-10'	0-10'		

c. *Additional Setback Standards.*

1. *In Existing Neighborhoods.* Front setbacks in existing neighborhoods shall match the front setbacks of existing adjacent structures for all frontage types except Arcade, Doorway, Gallery, and Storefront Frontage Types.
2. *For Parking Lots and Parking Garages.* At least 25' from any public right-of-way and at least 6' from any property line.

7.3.4 Height Standards

The Height of the primary building on a lot is regulated by T-Zone according to Table 7-8.

TABLE 7-8: BUILDING HEIGHTS	
T-Zone	Building Heights
T-2	No more than 2.5 stories for all Building Types.
T-3	No more than 2.5 stories for all Building Types. Live/Work Buildings and Flat over Flat Buildings shall at least 2 stories.
T-4	No more than 3 stories for all Building Types. Mixed-Use Buildings, Live/Work Buildings, and Flat over Flat Buildings shall be at least 2 stories. Mixed-Use Buildings and Live/Work Buildings shall have a first floor to ceiling height of 15' minimum.
T-5	At least 2 stories and no more than 4 stories for all Building Types. Mixed-Use Buildings, Live/Work Buildings, and Small Commercial Buildings shall have a first floor to ceiling height of 15' minimum.
T-6	At least 2 stories and no more than 10 stories for all Building Types.
D	No more than 4 stories
CS	No Height Limitation
Applicable to all Zones:	Accessory Buildings (Building Type V) shall not exceed the height of the primary structure.

7.3.5 Lot Size and Area Standards

Lot Sizes are regulated by T-Zone.

TABLE 7-9: LOT SIZE AND AREA	
T-Zone	Lot Size and Area
T-2	Minimum of 20 acres average per dwelling unit.
T-3	A mixture of lot widths is required in order to achieve residential diversity. The provision of small, medium, and large lot widths shall be achieved as follows: <ul style="list-style-type: none"> • Small Lots. At least 25% and no more than 50% of the total number of lots in T-3 shall be 25' to 45' wide. • Medium Lots. At least 25% and no more than 75% of the total number of lots in T-3 shall be 45' to 60' wide. • Large Lots. At least 15% and no more than 35% of the total number of lots in T-3 shall be more than 60' wide.
T-4	A mixture of lot widths is required in order to achieve residential diversity. The provision of small, medium, and large lot widths shall be achieved as follows: <ul style="list-style-type: none"> • Small Lots. At least 25% and no more than 75% of the total number of lots in T-4 shall be 16' to 40' wide. • Medium Lots. No more than 50% of the total number of lots in T-4 shall be 40' to 60' wide. • Large Lots. No more than 25% of the total number of lots in T-4 shall be more than 60' wide and limited to no more than 1 per block.
T-5	No minimum lot size. Lot widths are limited to no more than 60'. Lots with Common Lawn Frontages have no maximum lot width.
T-6	No minimum.
CS	No lot size regulation.
D	By Special Review of Regulating Plan

7.4 USE STANDARDS

- 7.4.1 Allowed Uses
- 7.4.2 Functional Intensity Standards
- 7.4.3 Use-specific Standards

7.4.1 Allowed Uses

Form-Based Codes are intended to allow a wide variety of uses and structures. Table 7-10 is a default use table by T-Zones. Each individual form-based code may propose alterations to this table through its Regulating Plan, when justified by specific planning and urban design principles for that plan. The table introduces the refinement of –R (“restricted”), -L (“limited”), and –O (“open”) for the T-3 and T-4 zones. This is an example of how uses may be further controlled within T-Zones of any particular plan while the scale, building form and urban design elements may be the same. For all Form-Based Codes each use, whether permitted, administrative, or conditional, shall meet the Lot and Building Type Standards (7.3), the Site and Building Standards (7.5), and the Functional Intensity Standards (7.4.2) for that T-Zone. The allowance of that use by Table 7-10 shall not alone be justification for deviating from the form and urban design standards of that T-Zone.

TABLE 7-10: ALLOWED USES AND T-ZONES

T-ZONES >	T-1	T-2	T3-R	T3-L	T3-O	T4-R	T4-L	T4-O	T5	T6	CS	D
▼ CATEGORY OF USES / SPECIFIC USES												
Residential Uses												
<i>Detached Dwelling</i>	P		P	P	P	P	P	P	P			
<i>Semi-attached Dwelling (“Duplex”)</i>			C	P	P	P	P	P	P			
<i>Attached Dwelling (“Townhouse”)</i>				C	P	P	P	P	P			
<i>Group Housing</i>	C	C	C	C	C	C	C	C				
<i>Dormitories</i>							C	A	A			
<i>Multi-dwelling Building (“Apartment”)</i>					C	P	P	P	P	P		
<i>Live/Work</i>					C	C	A	P	P	P		
<i>Mixed-use Dwelling</i>					C	C	A	P	P	P		
<i>Accessory Dwelling</i>	P	P	P	P	P	P	P	P	P			
<i>Manufactured housing parks</i>												
Civic Uses												
<i>Neighborhood Assembly (<350 maximum occupancy)</i>			A	A	A	P	P	P	P	P		
<i>Community Assembly (350 – 1000 max. occupancy)</i>							C	C	C	C		
<i>Cemeteries</i>			C	C	C	C	C	C	C	C		
<i>Primary and secondary schools</i>			C	A	A	A	A	P	P	P		
<i>Educational facilities</i>			C	C	C	C	A	P	P	P		
<i>Community Athletic Field</i>					A		A	A	C		A	
<i>Developed Athletic Field or Stadium</i>					C		C	C	C		C	

ARTICLE 7

FORM-BASED CODES

7.4 USE STANDARDS

TABLE 7-10: ALLOWED USES AND T-ZONES

T-ZONES >	T-1	T-2	T3-R	T3-L	T3-O	T4-R	T4-L	T4-O	T5	T6	CS	D
▼ CATEGORY OF USES / SPECIFIC USES												
Service Uses												
Service Business – Limited				C	P		C	P	P	P		
Service Business – General								C	P	P		
Adult Care – Assisted Living			C	A	P	P	P	P	P	P		
Adult Care – Nursing Home					C	C	A	P	P	P		
Animal Care - Kennel					C	C	C	C	C	C		P
Animal Care – Hospital / Clinic					A		A	A	P			
Child Care, In Home - Minor		C	C	C	C	A	A	A	P			
Child Care, In Home - Major						C	A	P	P	P		
Child Care, Center - Minor							C	A	P	P		
Child Care, Center - Major							C	A	P	P		
Entertainment, Indoor Recreation Facility						C	C	A	P	P		P
Entertainment, Outdoor Recreation Facility												P
Entertainment, Venue (1000 + maximum occupancy)						C	C	A	P	P		
Lodging, Bed and Breakfast	P	P	C	A	P	P	P	P	P	P		
Lodging, Hotel / Motel					C		C	A	P	P		
Medical Care, Clinic					C		C	A	P	P		
Medical Care, Office					A	C	A	P	P	P		
Medical Care, Hospital					C			C	C	C		P
Storage, Personal								A	A	A		
Storage, Park								C	C			
Storage, Yard								C	C			
Employment Uses												
Home occupations	A	A	A	A	A	A	A	A	A			
Office – Limited (<3,500)					C	C	A	P	P	P		
Office – General (3,500 – 20K)						C	A	P	P	P		
Office – Major Office Complex (>20K)								A	P	P		
Commercial Uses												
Convenience Retail / Corner Store (<2k)					A	C	A	P	P	P		
Neighborhood Retail (2K - 5K)					A	C	A	P	P	P		
General Retail (5K - 25K)							A	P	P	P		
Large-scale Retail (25K - 100K)								A	P	P		
Warehouse Retail (> 100K)								C	C			P
Grocery Store <45,000K						C	A	P	P	P		P
Supermarket > 45,000K								C	C	C		P

ARTICLE 7

FORM-BASED CODES

7.4 USE STANDARDS

TABLE 7-10: ALLOWED USES AND T-ZONES

T-ZONES >	T-1	T-2	T3-R	T3-L	T3-O	T4-R	T4-L	T4-O	T5	T6	CS	D
▼ CATEGORY OF USES / SPECIFIC USES												
Outdoor Sales, Limited	A	A			A	A	A	A	A	A		A
Outdoor Sales, Seasonal	A	A			A	A	A	A	A	A		A
Outdoor Sales, Event and Display Area	C	C			C	C	C	C	C	C		C
Outdoor Sales or Storage												P
Bars and liquor stores					C		C	P	P	P		P
Automobile Service Repair					C		C	A	A	A		P
Automobile Service Station - Limited					A		A	A	A	A		P
Automobile Service Station - General								C	C			P
Automobile Service Station – Large-scale												P
Food Service – Limited (under 2K)					A	A	A	P	P	P		P
Food Service – General (2K – 4K)					C	C	A	P	P	P		P
Food Service – Large-scale (over 4k)							C	A	P	P		P
Industrial Uses												
Limited Industrial	C	C			A		A	P	P	P		P
Light Industrial								C	C			P
General Industrial												P
Heavy Industrial												C
Salvage yards												C
Junk yards												C
Pet crematory												C
Air cargo terminals												
Aircraft sales, repair, service, storage and relating uses												
Railroad yards and maintenance buildings												
Public Service Uses												
Commercial and Public Parking Facility								C	C	C		
Government Facility				A	A		A	A	A	A		
Military												P
Recycling Services					C		C	C	C			
Transportation facilities								C	C	C		
Utility Stations			C	C	C	C	C	C	C	C		C
Agriculture Uses												
General Agriculture	P	P										
Limited Agriculture	P	P	C									
Agricultural equipment or product sales		C										
Commercial stables, arenas, kennels and show barns		C										
Nurseries, Landscaping	C	C						C	C			P
Work Camp	C											C

P = Permitted, C = Conditional, A = Administrative

7.4.2 Functional Intensity Standards.

In addition to the Lot and Building Type Standards, allowed uses are further limited in intensity by T-Zone. These limitations are by location, building size and uses are governed by T-Zone, lot location, and parking requirements:

TABLE 7-11: FUNCTIONAL INTENSITY STANDARDS	
T-Zone	Functional Intensity
<i>Applicable to all Zones</i>	<i>Applicable to All Uses:</i> Use is limited by the parking requirement of Section 7.5.1. Any use that by its intensity requires more parking than is permitted in 7.5.1 shall be prohibited. <i>Residential:</i> Only one accessory unit or accessory structure shall be allowed per main structure.
T-2	Lodging: The number of bedrooms permitted on each lot for lodging is limited to a maximum of 12 bedrooms.
T-3	Lodging: The number of bedrooms permitted on each lot for lodging is limited to a maximum of 12 bedrooms. Office: The building area available for office use on each lot is restricted to the first story of the principal or the ancillary building. Retail: The area in T-3 available for retail use must be designated on the Regulating Plan. The total area of retail in T-3 is limited to 500 square feet at the first story for each 100 dwelling units existing or planned within ¼ mile.
T-4	Lodging: The number of bedrooms permitted on each lot for lodging is limited to a maximum of 12 bedrooms. Office: The building area available for office use on each lot is restricted to the first story of the principal or the ancillary building. Retail: The building area available for retail use is restricted to block corner locations at the first story. Residential: In order to ensure a diversity of residential opportunities, a minimum of 3 of the Allowed by Right building types must be constructed, not including Accessory Units. Each type must account for at least 10% of the total number of units within this zone only.
T-5	Residential: In order to ensure a diversity of residential opportunities, a minimum of 3 of the Allowed by Right building types must be constructed, not including Accessory Units. Each type must account for at least 10% of the total number of units within this zone only.

7.4.3 Use-specific Standards.

In meeting of the intent of this Article, a Regulating Plan may propose use-specific standards to govern areas within a plan. In the event that no such standards are provided, all future development shall either meet any use-specific standards included in Section 5.7, in addition to all other applicable standards of the Regulating Plan and Form-Based Code, or the use shall be interpreted as not permitted by the Regulating Plan and Form-Based Code. In the event of a conflict between any standards in Section 5.7 and the standards of a Regulating Plan and Form-Based Code, the more strict standard in terms of meeting the purposes and intent of this article shall apply.

7.5 SITE AND BUILDING STANDARDS

- 7.5.1 Parking
- 7.5.2 Signs
- 7.5.3 Landscape
- 7.5.4 Site and Building Design

7.5.1 Parking

Parking shall meet the standards of Article 6, Section 6.2 with the following exceptions:

- a. Office and retail uses shall only be required to provide 2 parking spaces per 1000 square feet of gross leasable area.
- b. There is no parking requirement in the T6 zone.
- c. Any changes to the design and layout standards for parking provided in Article 6 shall be specified in the Design Manual associated with the Regulating Plan.
- d. Any Regulating Plan may propose alternative parking standards if based on a district-wide approach which includes long-term management of the parking supply, design, and maintenance.

7.5.2 Signs

Signs shall meet the standards of Article 6, Section 6.5, with the following exceptions:

- a. Any Regulating Plan may propose specific standards that supplement or amend the sign standards by a specific Design Manual approved in conjunction with a specific Regulating Plan and Form-Based Code as provided in Section 7.1, provided they offer clear standards and a mechanism for enforcement in association with approval of the Regulating Plan.
- b. Any residential building type shall be permitted signs according to the residential district standards. Any non-residential or mixed-use building types shall be allowed signs according to the non-residential district standards.

7.5.3 Landscape

Landscape design shall meet the standards of Article 6, Section 6.3, except that any Regulating Plan may propose specific standards that supplement or amend the landscape standards. Exceptions shall be noted in a Design Manual approved in conjunction with a specific Regulating Plan and Form-Based Code as provided in Section 7.1, and shall offer clear standards and a mechanism for enforcement in association with approval of the Regulating Plan.

7.5.4 Site & Building Design

- a. **In General.** The Residential Design Standards (Article 6, Section 6.6) shall apply to residential building types, the Small-scale Commercial and Mixed-Use Design Standards (Article 6, Section 6.7) shall apply to non-residential building types unless altered or supplemented by a specific Design Manual approved in conjunction with a specific Regulating Plan and Form-Based Code as provided in Section 7.1.
- b. **Residential Building Materials.** The following building material provisions shall apply for residential buildings in addition to the other provisions in Article 6, Section 6.6, unless altered or supplemented by a specific Design Manual approved in conjunction with a specific Regulating Plan and Form-Based Code as provided in Section 7.1:
 - 1. **Primary Materials.** All buildings shall have one primary material covering at least 65% of the building facades.
 - 2. **Secondary Materials.** Buildings may have a secondary material covering up to 35% of the facades.
 - 3. **Accent Materials.** Buildings may have up to two accent or trim materials covering no more than 10% of the building facades in total, however no building shall use more than three materials for primary, secondary, and accent combined.
 - 4. **Permitted Materials.** Exterior materials shall be permitted in accordance with the following table:

Primary Materials	Secondary Materials	Accent / Trim Materials
Brick, unpainted with natural or muted tones.	Any of the Primary Materials may be used as Secondary Materials	Any of the Primary or Secondary Materials may be used as an accent material
	Standing Seam Metal	
	Color Concrete	
Stone, unpainted with natural earth tones.	Horizontal Wood Clapboard (or equal or better simulated material) (natural or earth tones; or subtle or muted colors)*	Wood trim (or equal or better simulated material)
	Wood shingles (or equal or better simulated material) (natural or earth tones; or subtle or muted colors)*	Precast stone, or wood moldings or similar architectural details (or equal or better simulated material)
Stucco (or equal or better simulated material)		

* Detached Houses may use Horizontal Wood Clapboard or Wood Shingles as the primary material provided that a masonry material (Brick, Stone or Stucco) is used as a secondary material and comprises at least 25% of the total of all facades.

5. *Material Changes.* Except for accent materials, changes in the façade material shall only occur at horizontal expression lines, with the heavier material below the lighter material. Alternatively, changes in the material may occur at differentiated structural bays that meet the horizontal massing goals.
6. *Equal or Better Simulated Materials.* Where “equal or better” simulated materials are permitted, they shall only be permitted as an Administrative Adjustment by the Director according to the procedures and criteria in Article 2. In addition to these criteria, the Director may only permit “equal or better” simulated materials only where specified in the permitted materials section and upon finding that:
 - (a) The proposed material has an identical physical appearance as the material it is intended to simulate, including color and texture, as perceived from any public spaces surrounding the property;
 - (b) The material presents benefits in addition to cost savings, such as reduced maintenance, or enhanced durability and performance;
 - (c) The material has a demonstrated track record of successful application and use that will result in equally long-lasting and sustainable appeal of the neighborhood as that of the permitted materials; and
 - (d) Use of equal or better materials may be conditioned upon compliance with all application and manufacturer specifications.

APPENDIX

APPENDIX C – TRANSPORTATION WORKSHEET

The following transportation Worksheet shall be filled out in association with Sections 3.1.1 and 3.1.2 of this Code.

Project Name: _____ By: _____

Date: _____ Title: _____

Property Address or Legal Description (lot, block, subdivision): _____ Address: _____

Phone: _____

Fax: _____

Existing Zoning: _____

E-mail: _____

Developer: _____

Part One: All Developments

Provide the following information, to the best of your knowledge, for all projects:

1. Has a previous Transportation Impact Study (TIS) been prepared for the site? Yes ____ No ____
2. Are there proposed street intersections included with this development? Yes ____ No ____
3. Are there existing intersections affected by the development action(s)? Yes ____ No ____
If yes, which? _____
4. What is the proposed year of build-out? _____
5. Will the project be phased? Yes ____ No ____
If yes, what is the proposed phasing plan? _____
6. Are there other proposed developments in the study area? _____
7. Are there other committed roadway improvements in the area? _____
8. Are there proposed roadway improvements to be provided by the Applicant with this project? _____

9. Are there bicycle and pedestrian attractions near the development? (Existing or imminent within 1320' of the site. This distance may be increased up to 1.5 miles for residential projects near existing or proposed school sites.)
Yes ____ No ____

Part Two: Non-residential Development

Provide the following information, to the best of your knowledge, for all non-residential projects:

A. Existing Use:

1. Description of existing land use: (if none, proceed with Part B): _____
2. Existing building area (square footage) for above use(s): _____
3. Number of employees on site each day: _____
4. Daily trip ends for employees [multiply line 3 by the number 4]: _____
5. Number of customers on site each day: _____
6. Daily trip ends for customers [multiply line 5 by the number 2]: _____
7. Number of vendors on site each day (include trash, UPS, etc.): _____
8. Daily trip ends for vendors [multiply line 7 by the number 2]: _____
9. Total vehicular daily trip ends [line 4 plus line 6 plus line 8]: _____
10. How many Company Vehicles are used daily: _____
11. How many Company Vehicles will be parked on site: _____
10. Source of trip generation data (circle one): ITE, business records, traffic engineer, personal estimates, other: _____
_____. Attach documentation to support your data.
11. Number of accesses, width, and type of drive surface exiting onto the public street(s) from this property: _____
12. Number of pedestrians visiting site each day: _____
13. Number of bicyclists visiting site each day: _____
14. Do sidewalks exist along all street(s) adjacent to property? Yes ____ No ____
15. Is property adjacent to a major collector or arterial street? Yes ____ No ____

B. Proposed Use:

1. Description of proposed land use: _____
2. Proposed building area (square footage) for above use(s): _____
3. Anticipated number of employees on site each day: _____
4. Daily trip ends for employees [multiply line 3 by the number 4]: _____

- 5. Anticipated number of customers on site each day: _____
- 6. Daily trip ends for customers [multiply line 5 by the number 2]: _____
- 7. Anticipated number of vendors on site each day: _____
- 8. Daily trip ends for vendors [multiply line 7 by the number 2]: _____
- 9. Total vehicular daily trip ends [line 4 plus line 6 plus line 8]: _____
- 10. Source of trip generation data (circle one): ITE, business records, traffic engineer, personal estimates, other: _____
 _____, Attach documentation to support your data.
- 11. Proposed number of accesses onto the public street(s) from this property (does NOT include any existing accesses proposed to remain for use): _____
- 12. Number of existing accesses proposed to remain and be used: _____
- 13. Number of pedestrians visiting site each day: _____
- 14. Number of bicyclists visiting site each day: _____
- 15. Do sidewalks exist along street(s) adjacent to property? Yes ____ No ____
- 16. Property is not adjacent to a major collector or arterial street as shown on the City's Master Transportation Plan.
 Yes ____ No ____
- 17. Is a zone change requested? Yes ____ No ____
- 18. If yes, the existing zone is _____, and the proposed zone is _____.

If the total new trips (the difference between the daily trip ends calculation for any existing use and the total daily trip ends calculation for any existing use and the total trip ends calculated for the proposed use) is less than 500 and if peak hour and/or daily traffic counts demonstrate that the existing traffic plus the site generated traffic volumes are within the limits by these standards, you (the applicant) may request a waiver of the Transportation Impact Study submitted requirements by signing below.

Signature: _____ Date: _____

Transportation Impact Study Required: _____	Transportation Impact Assessment Required: _____	TIS Waived: _____
By: _____		Date: _____

Part Three: Residential Development

Fill out the table below and indicate in the table the number of dwelling units or access changes proposed for the type(s) of residential development included in your development. If the number of dwelling units and changes in access are less than the thresholds established above and if peak hour and/or daily traffic counts demonstrate that the existing traffic plus the site generated traffic volumes are within the limits set by City policy, you (the applicant) may request a waiver from the TIS requirement by signing your name below. Provide the following information, to the best of your knowledge, for all residential projects:

NUMBER	RESIDENTIAL DEVELOPMENT TYPE
	Single-family detached/dwelling units
	Multi-family dwelling units in duplex, tri-plex, or four-plex structures
	Multi-family dwelling units in structures containing five or more units
	Access changes onto a collector or arterial roadway

Signature: _____

Date: _____

Transportation Impact Study Required: _____	Transportation Impact Assessment Required: _____	TIS Waived: _____
By: _____		Date: _____

APPENDIX D [RESERVED]

APPENDIX E PEDESTRIAN AND BICYCLE GUIDELINES

E-1	Intent
E-2	Responsibilities
E-3	Standards
E-4	Specifications
E-5	Site Designs General Connectivity Requirements
E-6	Design Features and Accommodations for Pedestrians
E-7	Pedestrian Crossings at High-use Pedestrian Areas
E-8	Mid-block Crossings
E-9	Crosswalk Locations and Warrants
E-10	Elevated Crosswalk to Refuge Island
E-11	Bulbouts/Curb Extensions
E-12	Modern Roundabouts
E-13	Design, Location, and Type of Bicycle Parking Facilities

E-1 INTENT

Sidewalks and bicycle facilities are integral to the transportation system. The Pedestrian Level of Service Guidelines are intended to ensure that pedestrian interests and bicycle interests are considered in all analysis of the study, analysis, planning, design, engineering, and construction of transportation facilities. They are also intended to ensure that any flexibility in the transportation standards of this code is executed in a manner that is most appropriate to the context and site, and that it properly balances pedestrian and bicycle interests with other transportation interests.

E-2 RESPONSIBILITIES

The builder on the lot is responsible for sidewalk construction. Where sidewalks are not directly related to a lot, the construction of sidewalks is the responsibility of the developer. A certificate of occupancy will not be issued until sidewalks required by the approved site plan are constructed and approved.

E-3 STANDARDS

Sidewalks shall be provided for any portion of a site which abuts a roadway. All sidewalks shall be in the public right-of-way. Sidewalk width will be as specified in Article 4 of this code. When a sidewalk abuts angled parking such that there will be vehicular overhang, the sidewalk shall be a minimum of six feet in width. Curb ramps shall be provided wherever an accessible route crosses a curb as per the current ADA Accessibility Guidelines. Driveways shall also be constructed in accordance with current ADA Accessibility Guidelines. Where there is adequate right-of-way, the construction of the sidewalk independent of the curb and gutter section is required. The area between the sidewalk and the back of the curb shall be appropriately landscaped. Sidewalks in the Downtown Development District shall conform to streetscape recommendations set forth in the *Cheyenne Downtown Streetscape Design and Improvement Standards*, available at the Cheyenne MPO Office.

E-4 SPECIFICATIONS

Sidewalk construction and removal shall be in accordance with the current *City of Cheyenne and Board of Public Utilities Construction Standards and Specifications*. Curb ramps are illustrated in Standard Drawings of the specifications.

NOTE: The requirements of the Americans with Disabilities Act for sidewalks, curb ramps and protruding objects change from

time to time. Persons designing or building sidewalks should verify with the City Engineer that they are using the current criteria. Sidewalks shall be a minimum of 4 inches thick, except where traversed by driveways, in which case the driveway thickness shall govern.

E-5 SITE DESIGNS GENERAL CONNECTIVITY REQUIREMENTS

The following sections identify general connectivity standards, features, and accommodations for pedestrians.

- A. Safe and convenient pedestrian access from the development site should be provided to existing designated trails or greenways located on or adjacent to the development site. On-site connections should be made at points necessary to provide direct pedestrian travel from the development to major pedestrian destinations located within the adjacent neighborhood(s), including but not limited to parks, schools, commercial districts, and transit stops.
- B. In order to provide direct pedestrian connections to these adjacent destinations, the City may require additional sidewalks, walkways, or bike paths not associated with a street, the extension of a sidewalk from the end of a cul-de-sac to another street or walkway and/or connections between developments.
- C. Paths, when built to the standards of the Greater Cheyenne Area Greenway and in 20' public right-of-way, will be maintained by City Parks and Recreation Staff. All commercial retail, office, industrial and residential apartment developments should provide for the following design elements:
 1. Wide, safe front sidewalk;
 2. Direct pedestrian sidewalks to surrounding properties, transit stops, and sidewalks along the surrounding street;
 3. Locate major entry driveways away from front of stores where pedestrians must cross, and enhance them with pedestrian facilities such as sidewalks and cross walks;
 4. Canopies in front of stores to offer weather protection; and
 5. Pedestrian plazas.

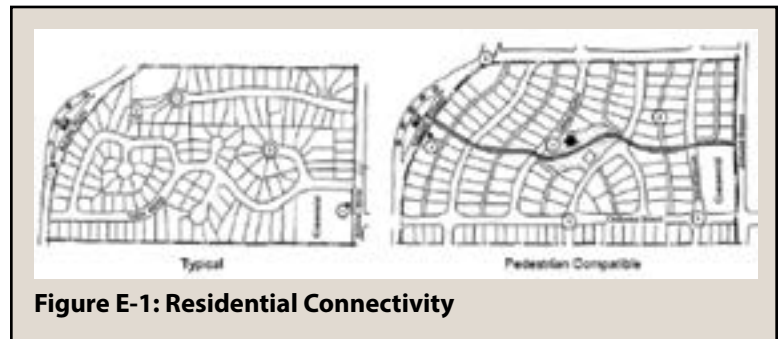

Figure E-1: Residential Connectivity

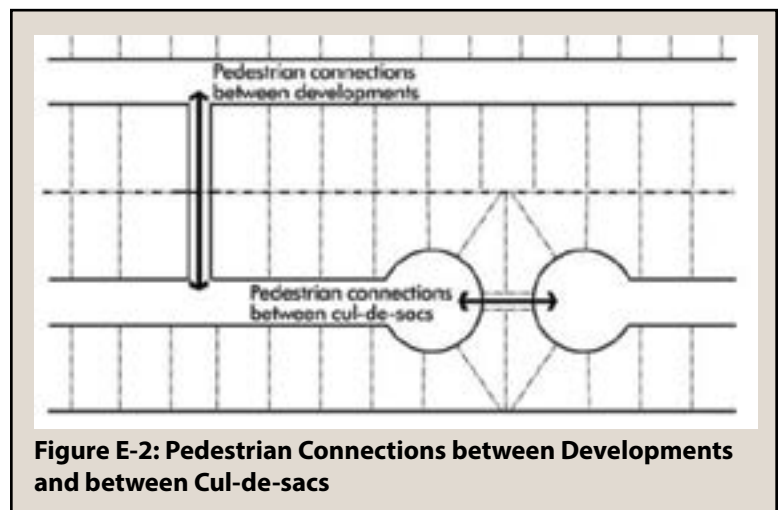

Figure E-2: Pedestrian Connections between Developments and between Cul-de-sacs



Figure E-3: Commercial Retail Shopping Center

- D. The following exhibits provide examples of typical developments as compared to developments with pedestrian-compatible improvements. These examples illustrate the same development yield for the site, illustrating that good pedestrian connection and development opportunities are compatible and efficient.

E. When necessary to assure the public’s safety in using on-site or connecting pedestrian sidewalks, the City may require the developer to provide on-site or off-site pedestrian overpasses, underpasses, or traffic signalization. These connections are particularly important for providing pedestrian connections to transit stops, schools and parks.

F. Each development should provide and contribute to an on-site system of pedestrian walkways. To the maximum extent feasible, on-site walkways should provide the most direct access route between the intended points of travel. Specifically, pedestrian connections should be provided to and between the following points:

1. The primary project entrance or entrances to each building housing a principal use,
2. Any sidewalk or walkway on adjacent properties that extends to the boundaries shared with the development,
3. Any public sidewalk system along the perimeter streets adjacent to the development site, existing or planned transit stations, shelters, stops and park-n-ride locations, and
4. On-site amenities such as landscape/hardscape, benches, pedestrian lighting.
5. All on-site and public sidewalks, pedestrian walkways, or trails should have and maintain a minimum unobstructed pathway width of at least 4.5 to 6 feet, and as otherwise specified by the street design standards.

E-6 DESIGN FEATURES AND ACCOMMODATIONS FOR PEDESTRIANS

To the maximum extent feasible, the following guidelines should be incorporated in the design of all new developments to ensure safe and convenient pedestrian access into and within the site, with minimum potential for conflict with motor vehicles. These design elements complement the five measures of pedestrian level of service: directness, continuity, street crossings, visual interest and amenity, and security.

- A. **Directness.** Developers should provide and encourage direct pedestrian connections by adhering to the following guidelines.
1. Provide direct pedestrian connections to transit, schools, activity areas, and public facilities.

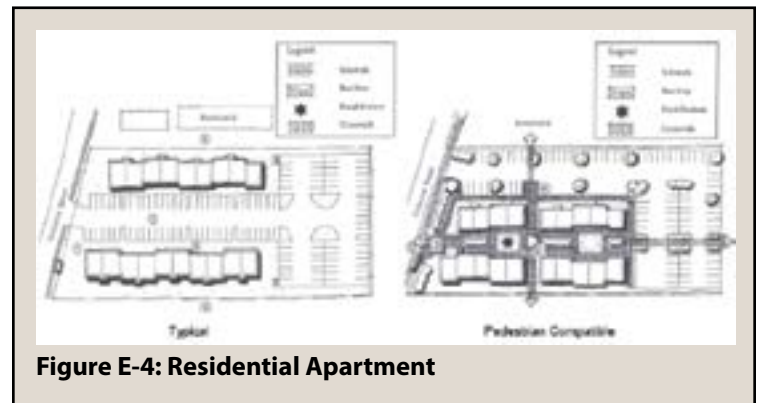

Figure E-4: Residential Apartment

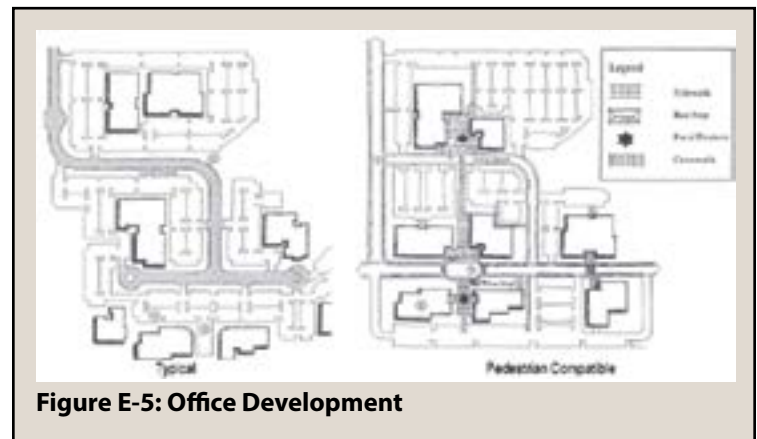

Figure E-5: Office Development

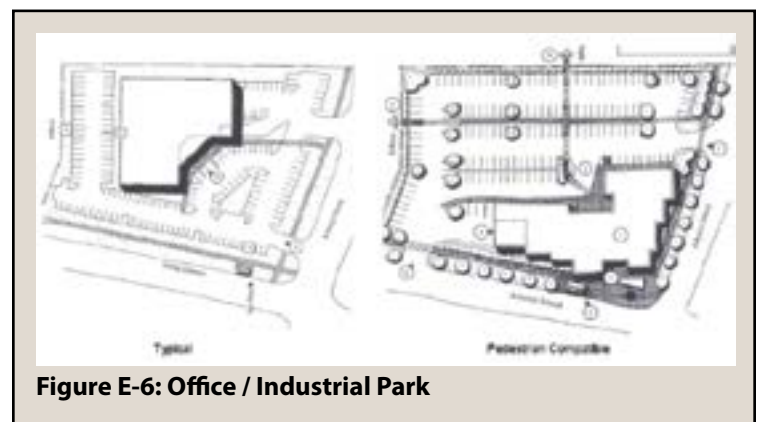

Figure E-6: Office / Industrial Park

2. Provide visible connections to key pedestrian destinations. Align and locate buildings, roadways, and open space so that pedestrians can see their destinations before arriving there.
3. Provide clearly marked building entries as viewed from the street. Entries from parking lots should be subordinate to those related to the street. Buildings should be sited in

ways to make their entries or intended uses clear to pedestrians.

4. The location and pattern of streets, buildings, and open space must facilitate direct pedestrian access.
 5. Use light fixtures to provide direct indication for pedestrian traffic. Light fixtures should be of shielded type with flat level lenses when appropriate.
 6. Ensure that sidewalk uses, such as outdoor cafes, in high-use retail pedestrian settings, are compatible with direct pedestrian access to buildings and other destinations.
 7. Avoid barriers that separate commercial developments from residential development and transit.
 8. Locate buildings near street corners to improve access to bus stop and provide pedestrian connections to neighboring activities.
 9. Establish appropriate lot patterns that provide direct and visible connection of sidewalks between blocks.
 10. Provide direct connection between cul-de-sacs.
 11. Ensure appropriate width of sidewalks and street crossings to facilitate continuous movement of two people comfortably walking side by side with space for one to pass.
 12. Provide clear and direct pedestrian entries from the street, not just from parking areas.
 13. Minimize and remove physical obstructions/barriers that impede direct pedestrian access. Provide access through walls, fences, and other obstructing features and elements.
- B. **Continuity.** Link schools, neighborhoods, parks, activity centers, and other destinations with a continuous pedestrian network.
1. Provide a continuous and understandable pedestrian network by incorporating the following facilities, features, and elements:
 - a. Continuous sidewalks on both sides of the street,
 - b. A continuous alignment of building facades near the sidewalk,
 - c. A consistent park strip between the curb and the sidewalk, and
 - d. Consistent street trees.
 2. Use pedestrian-scaled furnishings, signs, landscaping, and facilities that appear as unified and themed entities in pedestrian networks, areas, and corridors.
 3. Ensure that sidewalk cafes and other uses/features of the sidewalk area support rather than obstruct a continuous pedestrian network.
 4. Provide bridges and crossings over drainages, and other features that are major barriers to a continuous pedestrian network. Design these crossings to minimize out-of-direction travel.
- C. **Street Crossings.** Develop safe, comfortable, and attractive street crossings.
1. Develop median refuges to improve the safety and comfort of arterial street crossings.
 - a. Establish standardized street-crossing improvements that include crosswalks, lighting, median refuges, corner sidewalk widening, sign, signals, and landscaping.
 - b. Develop and design crosswalks that:
 - i. Are well-marked and visible to vehicles,
 - ii. Fit and enhance the local urban design context and character, and
 - iii. Provide for safety for all age/ability groups.
 2. Develop civic improvements, including pedestrian-scale elements, landscaping, and sidewalk widenings, which improve the visibility and suggestion of pedestrians at street crossings.
 3. Develop street-calming improvements to enhance the safety of street crossings.
 4. Ensure that signals, signs, and street markings have clear vehicular and pedestrian indications for street crossings.
 5. Ensure that street crossings are lit to reflect the patterns of use.
 6. Provide automatic pedestrian signal phases at high-demand intersections and pedestrian buttons at low-demand areas.
 7. Provide for an exclusive pedestrian signal phase to improve safety.
 8. Consider installing stop bars on all approach legs at signalized intersections.

9. Minimize curb radius to:
 - a. Reduce the speed of right-turning vehicles.
 - b. Reduce the distance for the pedestrian to cross the street.
 10. Locate lighting, signal and signage poles so they do not conflict with safe pedestrian circulation.
 11. Allow access for people of different abilities.
- D. **Visual Interest and Amenity.** Develop comfortable and attractive pedestrian facilities and settings to make an interesting pedestrian network.
1. *Pedestrian Facilities and Elements:*
 - a. Provide pedestrian-scale improvements that fit the urban context of the area.
 - b. The color, materials, and form of pedestrian facilities and features should be appropriate to the area where they are located, as well as to the functional unity of the pedestrian network.
 - c. Develop attractive improvements including landscaping, vertical treatments, sidewalk widening, and furnishings which improve the character and pedestrian scale of the urban environment.
 - d. Incorporate special design features, public art, and site details that can enhance the pedestrian scale of streets and become an urban amenity.
 - e. Develop standardized lighting improvements which enhance the character of the pedestrian environment. Consider the following criteria:
 - i. Varied light spacing and heights to be compatible with site-specific issues.
 - ii. Poles to incorporate pedestrian-scale features such as banners, potted plants, etc.
 - iii. Attractive luminaries to provide an organized and unified appearance throughout the pedestrian network.
 - f. Use quality materials and design, which will minimize maintenance needs.
 - g. Maintain pedestrian facilities.
 - h. To enhance the character of the pedestrian environment and to encourage pedestrian activities along the sidewalks on key streets and corners, prohibit large surface parking lots in these locations.
 2. *Landscaping:*
 - a. Develop a continuous edge of deciduous canopy street trees on both sides of the street. Select species that provide shade, shelter, scale and continuity for the pedestrian/ sidewalk environment.
 - b. Develop attractive landscaping by considering the following criteria:
 - i. Reduce clutter of little plants and disorganized planting.
 - ii. Establish patterns/spacing of street trees to provide formal visual rhythm, a linear edge to, and organization of the sidewalk area.
 - iii. Use trees of similar height and structure to provide a unified image and cohesive character for feature corridors and districts.
 - iv. Use specialty-landscaping themes to help distinguish districts.
 - v. Use landscaping selectively to soften the harsh appearance of some buildings and parking lots at the sidewalk edge.
 - c. Construct retaining walls of materials which reduce their apparent scale, like brick or stone, or treated architecturally to create an appropriate scale and rhythm. Hanging or climbing vegetation can soften the appearance of retaining walls. High retaining walls should be terraced down and include landscaped setbacks.
 - d. Design attractive urban open spaces to have a distinctive and definite shape, enclosed by buildings on 2-3 sides so the area feels like an "outdoor room," which is favored by pedestrians. These spaces must be located in the right places to be useful. Locate at intersections of 2 or more pedestrian routes.
 - e. Screen blank building walls and retaining walls with landscaping, architectural features, or art to enrich the pedestrian environment.

3. *Buildings:*

- a. Encourage outdoor cafes and activity areas that provide pedestrian character and human scale to the sidewalk environment.
- b. Construct windows and other openings that will relieve blank walls, adding visual interest, improving pedestrians' sense of security, and introduce a human scale to building frontages.
- c. Provide human scale character to the street with appropriate building design and details.
- d. Incorporate building entry details like porches and recesses, occupied spaces like bay windows and balconies.

E. **Security:**

1. Develop secure pedestrian settings by developing a well-lit inhabited pedestrian network and by mitigating the impacts of vehicles.
2. Streets should appear inhabited to the greatest extent possible. New development should accommodate human activity by providing balconies, terraces, and yards for residents' use and interaction. In mixed-use buildings, retail elements like large windows, canopies, and integrated signage add activity by enhancing the shopping experience. Entrances, porches, balconies, decks, and seating should be located to promote pedestrian use of the street edge by providing weather protection, security, and safety.
3. Provide clear and direct lines of sight in pedestrian settings to increase feelings of security. Achieve this by minimizing use of shrubs, walls, berms, and other vertical features, which screen lines of sight to pedestrian facilities.
4. Provide general illumination for security and visual safety of pedestrian areas and corridors.
5. Use lighting fixtures to identify and highlight key pedestrian facilities and elements such as pedestrian intersections, paths, sidewalks, and entrances, while enhancing safety, and security. Provide a desirable and safe pedestrian environment by decreasing glare associated with tall, high intensity street fixtures. Provide indirect light to the sidewalk by lighting elements in the street environment such as trees, walkways, canopies, and entryways. All lighting should be down-directed and should not contribute to light pollution whenever possible.
- f. Develop physical buffers/edges between sidewalks and streets/parking lots.
- g. Avoid over-illumination of pedestrian areas, since these create, by contrast, shadowy areas nearby which may be threatening to pedestrians.

E-7 PEDESTRIAN CROSSINGS AT HIGH-USE PEDESTRIAN AREAS

The greater the number of lanes that a pedestrian must cross, the greater is the pedestrian's exposure to vehicles. In addition, wider streets tend to carry higher volumes of traffic and higher speeds. Intersections crossing multiple lanes require pedestrian enhancements. If it is determined that the traffic demand warrants additional through or turn lanes, then pedestrian mobility should be evaluated to determine whether additional pedestrian enhancements should be required to offset the traffic impacts on the pedestrian. The following are key intersection street-crossing design elements that should be considered in the guidelines for designing intersections.

- A. **Number of Lanes:** The number of travel lanes to cross is a significant safety factor for a pedestrian crossing the street. When the number of travel lanes increases, it is generally in response to higher traffic volumes. In addition, the pedestrian is exposed for a longer period of time in crossing those additional lanes.
- B. **Lane Widths:** Typically a travel lane is 12 feet. If the lane width is reduced, the time it takes a pedestrian to cross is also reduced. In addition, the narrower travel lane tends to calm or slow traffic, which is of benefit to the pedestrian.
- C. **Parking Lanes:** When parking lanes along a street exist, the pedestrian walk-time to cross the street increases as the pedestrian must first cross the parking lane before beginning to cross the traffic lanes. At intersections, vehicles that make wider, higher-speed turns often use these parking lanes.

- D. **Travel Speed:** Speed is a significant safety factor for a pedestrian trying to cross a street. Factors that might affect speed include minimum cross-street traffic, low number of access points, and geometric design. As mentioned previously, lane widths also contribute to travel speed.
- E. **Crosswalks:** Enhancements to crosswalks, including color, stenciling, and pavement treatment should be considered for all major intersection entryways to mixed-use centers.
- F. **Signal Indication:** Pedestrian signal heads should be included for all signalized intersections with crosswalks. The heads should be easily visible to the pedestrian.
- G. **Lighting Levels:** The intersection should be well lit so the pedestrian is visible at night.
- H. **Pedestrian Signal Indication and Pedestrian Buttons:** It would be optimal for all activity areas to have automatic pedestrian signal phases. Pedestrian push-buttons should be required for all other intersections. The location of the push-button should be easily accessed and not require pedestrians to divert from their travel route. Signals without dedicated walk phases or push-buttons are not acceptable since the only way a pedestrian may ever get a green light is when an automobile on the side street activates the cycle.
- I. **Countdown Signal Heads:** At signal locations that experience a high number of pedestrians, such as at transit stops or universities, where there have historically been a large number of pedestrian accidents, or any other area where pedestrians often cross during the “Do Not Walk” phase, countdown signal heads should be considered to provide additional information about how much time is remaining for being able to cross the street.
- J. **Median Refuge Areas:** Painted medians offer little refuge other than getting out of a lane of traffic. Substantive raised medians of significant width with a cut-through provide some increase in security for the crossing pedestrian. For arterials with four or more lanes, a raised median refuge island should be designed for all intersections and mid-block crossings.
- K. **Amenity:** In pedestrian districts, amenities should include such elements as signing and design features that strongly suggest the presence of a pedestrian crossing.
- L. **Line-of-sight Distance:** Sight distance measures the unobstructed view between the motorist and the pedestrian. This can be a problem particularly when a motorist intends to make a left turn under the permissive left-turn phase, and it is difficult to see pedestrians around the opposing left-turn vehicle. Sight distance should be analyzed as a part of all intersection designs.
- M. **Right Turn on Red (Left Turn on Red on One-Way Streets):** One of the greatest increases in pedestrian accidents has been associated with right turns on red lights. Research has determined that an extremely high number of drivers do not stop at the crosswalk before making their turn and, instead, continue on while looking to the left for approaching conflicting vehicles, not to the right for pedestrians in the crosswalk. Some jurisdictions have installed signs that do not permit right turns on red in specific places and circumstances. As part of the traffic study, locations that would experience high pedestrian volumes should be identified. Restricting right turns on red should be at the discretion of the City Engineer.

E-8 MID-BLOCK CROSSINGS

- A. Mid-block crossings should be provided where there is an existing or potential pedestrian demand to cross at higher volume roadways or streets where crossings are greater than 800 feet. Ideally, these crossings should be accommodated with a refuge island. Center crossing islands allow the pedestrian to deal with only one direction of traffic at a time and enable them to stop partway across the street and wait for an adequate gap in traffic before crossing the second half of the street.

- B. Where mid-block crosswalks are installed at uncontrolled locations (i.e., where no traffic signals or stop signs exist), crossing islands should be considered as a supplement to the crosswalk in order for the pedestrian to only cross one direction of traffic at a time. Providing an angled pedestrian travel way across the median allows oncoming traffic to be better viewed before crossing, further improving safety.

E-9 CROSSWALK LOCATIONS AND WARRANTS

- A. From a pedestrian-network perspective, extended distances between intersecting streets make it difficult for the pedestrian to cross the facility. Ideally, a system of grid streets that are around 400 feet in separation would be optimal. This distance would be appropriate for local streets within residential neighborhoods and activity centers. Spacing between intersections on primary arterials and secondary arterials might need to be longer to accommodate the higher volumes of traffic, storage for signals, and signal progression.

- B. The location and frequency of crosswalks along primary arterials, secondary arterials, and collector streets need to be balanced between need, traffic flow, and cost. Whereas an optimum pedestrian environment would have crosswalks at all major activity areas and spaced at 400-foot increments, too great a frequency of crosswalks can create a situation where the typical driver becomes immune to the crosswalk, which might create a safety hazard. The following should be considered when considering locations for crosswalks:

1. All signalized intersections,
2. Locations that will attract high pedestrian volumes,
3. Locations for safety, such as crosswalks to school sites, transit stops or activity areas, and
4. Mid-block crossings at a minimum of 350 feet from adjacent intersection crosswalks.

- C. In areas that have high volumes of pedestrians crossing a street, pedestrian crosswalks should be installed. The need for these crosswalks is a function of roadway type and pedestrian volumes. Roadway types from collector to primary arterial result in more travel lanes in which the pedestrian is exposed as he/she crosses, higher traffic volumes, and often increased traffic speeds. Figure E-8 is a guideline as to where unprotected intersection and mid-block crosswalks should be considered based on street width/type and pedestrian volumes.

E-10 ELEVATED CROSSWALK TO REFUGE ISLAND

In locations where a dedicated right-turn lane is needed as determined by the Traffic Impact Study, the design should consider a raised crosswalk at the height of the curb and a ramp for the vehicles to cross the crosswalk. This resulting design is similar to that of a 10-foot speed table with a six-inch up-ramp, table, and down-ramp.

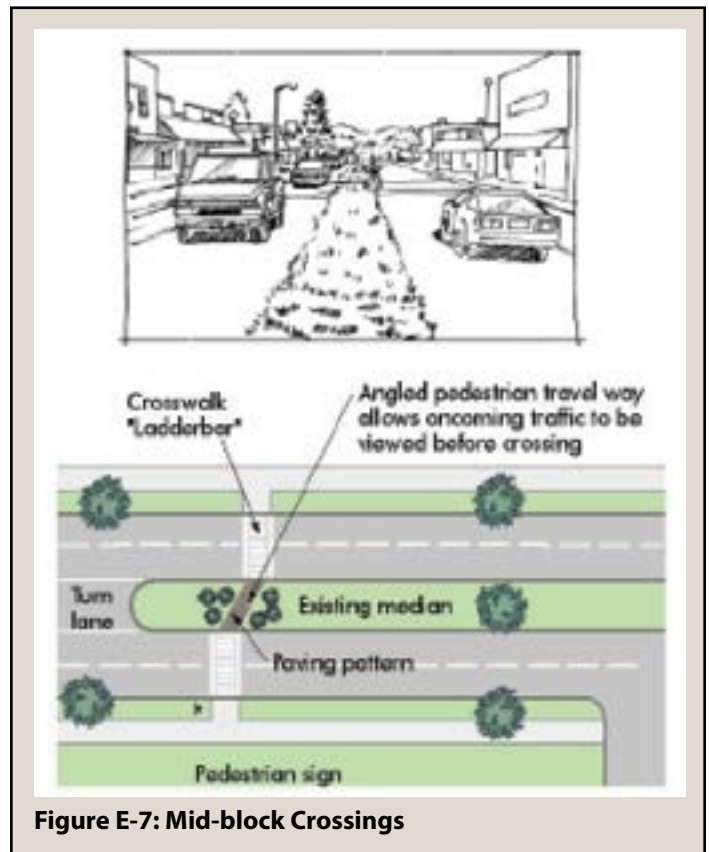

Figure E-7: Mid-block Crossings

E-11 BULBOUTS/CURB EXTENSIONS

In special applications, the City or developer may consider bulbouts to reduce traffic speed and improve pedestrian safety. Bulbouts are simply intersection curb extensions, which extend past the parking lanes, but not into the bicycle or through lanes. The advantages of bulbouts are as follows:

- A. Bulbouts provide an entry or gateway statement into activity areas or where high volumes of pedestrians are present. As a motorist enters an area where a bulbout is present, the extension provides a clear difference between the arterial function and a local pedestrian activity area.
- B. Bulbouts enhance the visibility of the pedestrian because they physically permit the pedestrian to be located closer to the travel lanes, especially where parking is permitted, and allow the pedestrian to be seen more easily by the driver.
- C. Bulbouts constrict traffic flow through reduced lateral clearance. This reduction effects a reduction in travel speed along the corridors and improves safety for both pedestrians and vehicles.
- D. The bulbout changes the turning radius at the intersection, which reduces turning speed and vehicle and pedestrian conflicts.
- E. The extension of the bulbout reduces the time it takes pedestrians to cross from curb to curb. This reduction in pedestrian crossing time consequently reduces the time the pedestrian is exposed to moving vehicles.
- F. Bulbouts change the character of the intersection from automobile-dominant to pedestrian-friendly and multi-modal shared.
- G. Bulbouts can be an extremely positive visual and aesthetic enhancement. Features such as pedestrian lighting, planters, and benches create a focal point for pedestrian activity and change the character of the intersection from automobile to pedestrian. It should be noted that care must be taken when aesthetically enhancing bulbouts as such enhancements can block sight distances and create accident problems.

E-12 MODERN ROUNDABOUTS

- A. The use of modern roundabouts as an alternative to conventional stop- and signal-control intersections is becoming increasingly popular in the United States. Studies conducted by the insurance industry have determined that these types of intersections result not only in a significant decrease in automobile traffic at an

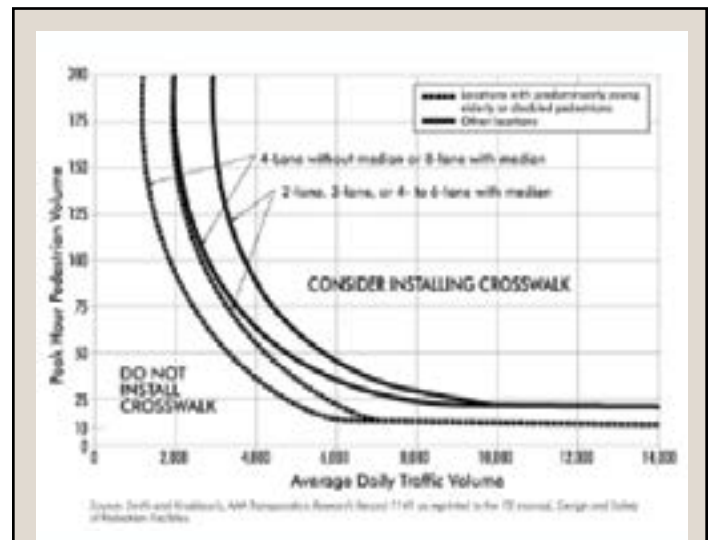

Figure E-8: Guidelines for the Installation of Marked Crosswalks at Uncontrolled Intersections and Mid-block Crossings

Source: Smith and Knoblauch, AAA, Transportation Research Record 1141 as reprinted in the ITE Manual, Design and Safety of Pedestrian Facilities

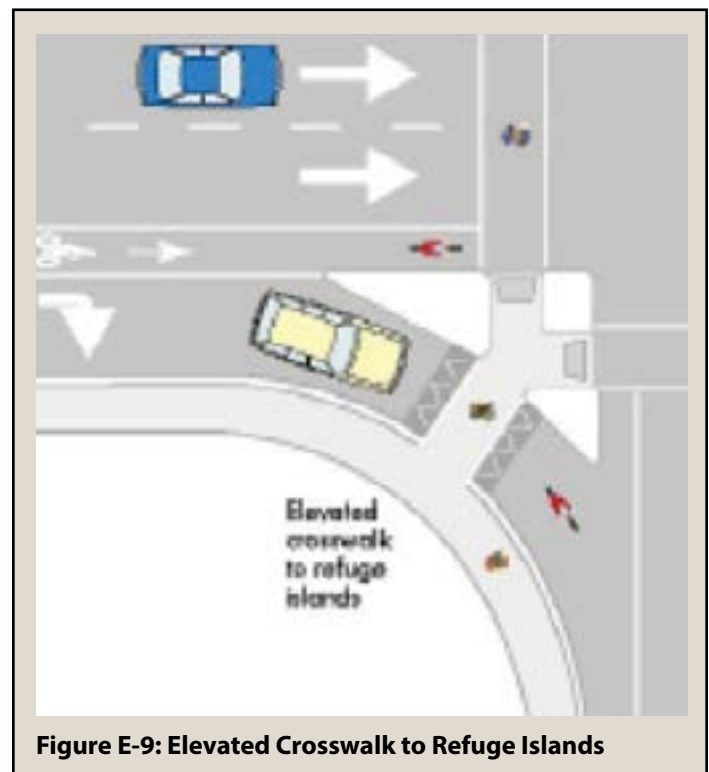

Figure E-9: Elevated Crosswalk to Refuge Islands

intersection, but also in a reduction in pedestrian accidents as well.

- B. At a conventional intersection, the pedestrian faces four potential vehicle conflicts:
 1. Crossing movements on red (typically high-speed, illegal)
 2. Right turns on green (legal)
 3. Left turns on green (legal for protected-permitted or permitted left turn phasing)
 4. Right turns on red (typically legal)

- C. Pedestrians at roundabouts, on the other hand, face two conflicting movements on each approach:
 1. Conflict with entering vehicle
 2. Conflict with exiting vehicle

- D. The crossing of the roundabout is relatively simple. The pedestrian waits for a gap in traffic and crosses from the curb to the splitter island that provides protection, and then crosses from the splitter island to the far curb when a gap in traffic occurs. Crossing in two steps reduces the vehicle exposure in half for each segment. In addition, safety is improved because the vehicles are forced to go slower through the roundabout than at a conventional intersection. The modern roundabout pedestrian crosswalk treatment consists of:
 1. ADA compliant ramps
 2. Conventional crosswalk striping
 3. Raised splitter island pedestrian pass-through and refuge
 4. Pedestrian crossing sign
 5. Yield street markings
 6. Yield signs

- E. Typically, the crosswalk is placed approximately one car length from the yield bar to permit the pedestrian to safely walk behind a vehicle that is awaiting a merge into the roundabout when traffic permits.

E-13 DESIGN, LOCATION AND TYPE OF BICYCLE PARKING FACILITIES

Convenient and secure bicycle parking is necessary at the destination end of a path or route. Inadequate bicycle parking facilities and fear of theft are major deterrents to bicycle transportation. A sufficient supply of effective bicycle parking requires a properly designed rack in an appropriate location for the type of use.



Figure E-10: Bulbout / Curb Extension

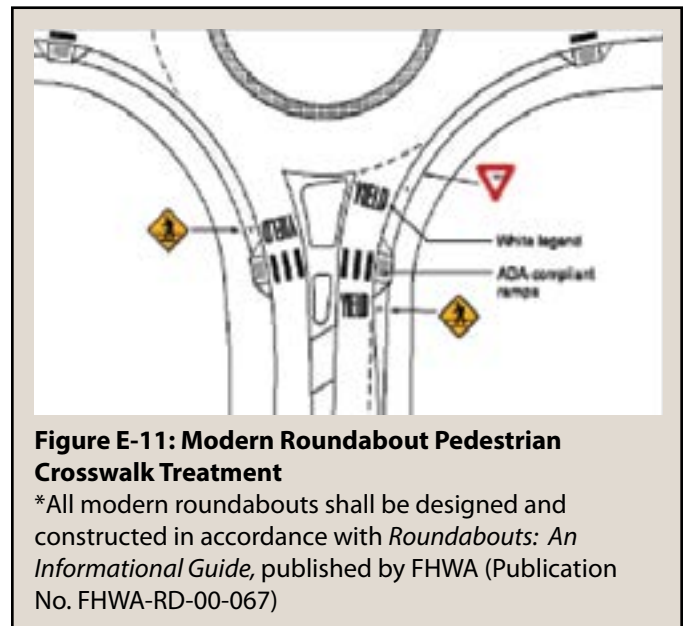

Figure E-11: Modern Roundabout Pedestrian Crosswalk Treatment

*All modern roundabouts shall be designed and constructed in accordance with *Roundabouts: An Informational Guide*, published by FHWA (Publication No. FHWA-RD-00-067)

- A. **Design Standards.** Bicycle facilities shall be designed in accordance with Chapter 2 of the *AASHTO Guide* for development of bicycle facilities. Traffic control shall be in accordance with the *Manual on Uniform Traffic Control Devices*. Bicycle parking may be provided in floor-, wall- or ceiling-mounted racks. Racks at each location should:
1. Hold the bicycle frame, not just a wheel.
 2. Allow use of a U-shaped shackle lock.
 3. Accommodate a wide range of bicycle sizes, wheel sizes and types.
 4. Be covered with material that will not chip the paint of a parked bicycle with which it comes in contact.
 5. Not have hazards, such as sharp edges.
- To ensure bicycle parking will be used, the bicycle parking should be easy to find, convenient, and secure enough to reasonably safeguard against bicycle theft. Facilities can be located where cycles are already parked.
- B. **Type and Location.** There are many types of bicycle racks and lockers available. Some are suitable for certain situations but not others, and some designs are unsuitable anywhere. There are two general categories of bicycle parking requirements:
1. *Long-Term (Class I)* parking is needed where bicycles will be left for hours at a time. It requires a high degree of security and weather protection, with well-designed racks in covered areas, lockers, storage rooms, or fenced areas with restricted access.
 2. *Short-Term (Class II)* parking is needed where bicycles will be left for short stops. It requires a high degree of convenience (as close to destinations as possible). At least some short-term bicycle parking should be protected from the weather (a portion can be unprotected, since demand tends to increase during fair weather).
- C. **Visibility.** Racks should be highly visible so cyclists can spot them immediately when they arrive from the street. A visible location also discourages theft and vandalism.
- D. **Security.** Adequate lighting and surveillance is essential for the security of the bicycles and the users. Bicycle racks and lockers must be well anchored to the ground to avoid vandalism and theft.
- E. **Weather Protection.** A portion of bicycle parking should be protected from the weather (some short-term bicycle parking can be unprotected since bicycle use tends to increase significantly during fair weather, as mentioned previously). This can use an existing overhang or covered walkway, a special covering, weatherproof outdoor bicycle lockers, or an indoor storage area.
- F. **Clearance.** Adequate clearance is required around racks to give cyclists room to maneuver and to prevent conflicts with pedestrians or parked cars. Racks should not block access to building entrances or fire hydrants.

APPENDIX F – GUIDELINES FOR PREPARING A JOINT PARKING STUDY

In association with Section 6.2.5 of this code, planning applications where collective or shared parking is contemplated may be required to include parking accumulation studies for existing facilities similar to the proposed uses and for the surrounding uses with which joint parking is being considered. The applicant shall adhere to the following guidelines:

- A. Prepare a scaled drawing indicating the parking areas and the facilities requiring parking in the area.
- B. Determine if shared parking is possible by examining the land-use mix adjacent to the subject site, the size of each use, the type of operation, and, most importantly, the 12- to 24-hour parking demand characteristics of each use.
- C. Conduct the 12- to 24-hour parking accumulation studies for existing facilities similar to those for which reciprocal parking is being requested, and for the surrounding ones with which shared parking is anticipated. Weekly and monthly variations in parking demand must be taken into consideration.
- D. Occupancy factors may be a consideration in determining how well the parking spaces for the existing adjacent uses, with which shared parking is being contemplated, are currently being utilized. These can be determined during the accumulation studies outlined above.
- E. Based on the data for existing similar facilities, the total parking demand for all uses included in the shared parking analysis must be projected for each hour over a 12- to 24-hour period for the most critical day of the week and month of the year. This must include the Thanksgiving-to-Christmas period, if the facilities are affected by this period. This will determine the minimum number of spaces that must be provided.
- F. Based on this analysis, if the maximum number of vehicles accumulated during a 24-hour period for all uses exceeds the number of spaces that were required by this code for all the uses, no reciprocal or shared parking will be permitted.
- G. If the projected peak accumulated demand is lower than the spaces required, elimination of those spaces exceeding the maximum accumulated demand may be considered by permitting shared parking, providing details of an agreement are provided guaranteeing perpetuity of such shared parking arrangements in case of future ownership or tenant changes.

APPENDIX G STREETScape DESIGN, PLANNING AND MAINTENANCE GUIDELINES

G-1	Intent
G-2	Applicability
G-3	Medians
G-4	Tree Lawns
G-5	Planting Guidelines
G-6	Planting Standards
G-7	Irrigation Standards
G-8	Turf Seeding Standards
G-9	Fine Grading and Soil Preparation Standards
G-10	Streetscape Maintenance Standards

G-1 INTENT

Streets are the most significant portion of the public realm of most communities – both in area and in investment. The intent of the Streetscape Design Guidelines is to ensure that the quality of the streetscape environment, including medians and tree lawns within the public right-of-way, is attractive, functional and links the public street corridors together through a unified City-wide plan.

G-2 APPLICABILITY

The Streetscape Design Guidelines are used in the evaluation of new development and redevelopment projects. The guidelines set forth acceptable standards and practices to meet development requirements and design objectives in this code. These guidelines apply to projects located within the public right-of-way along arterials, collectors, and local streets. For additional information on related streetscape design, see the City of Cheyenne's current editions of the *Landscape Design Regulations (UDC Section 6.3)*, *City Urban Forestry Ordinance*, and *Street Design Types (UDC Section 4.3)*.

G-3 MEDIANS

- A. **Landscape Plan.** All street designs that include a median shall submit a median landscape plan that meets or exceeds the standards of this section.
- B. **Timing of Median Landscaping.** Landscaping of medians shall occur in connection with the adjoining development or with improvement of the roadway as described below.
 1. *Arterial Streets.* Landscape development shall occur with the improvement of the roadway.
 2. *Non-arterial Streets.* Landscape development shall occur in connection with the adjoining development.
- C. **Median Planting Design Options.** Landscaping shall be based on one of the following styles:
 1. *Tree Corridor Style.* Deciduous trees shall be planted in an evenly spaced row. Ornamental trees may be planted in an evenly spaced row at the end of the median where the landscape area narrows. Trees should have variety. Yet, strong contrasts within tree rows should be avoided with repetition or subtle changes in form, size, texture, and color.
 - a. Tree plantings shall be made in the center of the landscape area at regular spacing of 25 feet minimum to 40 feet maximum. Shade or ornamental tree plantings shall not occur where the distance between median curbs is less than 7 feet.
 - b. Shrubs or groundcover plantings shall be made to provide a homogeneous surface with minimal amount of variation. Plant material shall have a mature height of 18 inches or less. Plantings may be excluded from the ends of

- medians for maintenance or visibility concerns.
 - c. Organic mulch shall be placed at a depth of 3 inches directly on top of the soil surface in all landscape areas. Fabric shall be placed on top soil under mulch as a weed barrier.
 - d. Landscape area within the median shall be graded level 3 inches below the edge. Berming or cresting the landscape area is not permitted.
 - e. Flowering annual or perennial plants shall be restricted to high visibility areas and may occasionally be used as a landscape element in a section of the street corridor in wider sections of medians. Separate irrigation zones shall be installed for annual beds.
 - f. The tree corridor style is appropriate for medians in any classification of street where the median is at least 7 feet in width.
2. *Variety Combination Style.* Trees and shrubs of several types and forms should be planted. Continuity is not provided by the perpetual repetition of individual elements but by the occasional repetition of a dominant tree form. This continuity may be achieved by planting groups of the same evergreen tree as a repeated form along the street corridor. Plant groups placed between the repetitive dominant tree forms may be in sharp contrast to each other—in terms of size, color, form, and texture—to emphasize visual variety and detail. Tree selection may be from shade, evergreen or ornamental types. The landscape area of a median must be 12 feet in width if evergreen trees are to be planted. Deciduous trees must be at least 3.5 feet, and evergreen trees 6 feet from the edge of the landscape area. Spacing between trees may vary within the following requirements:

TABLE G-1: SIZE AND SPACING OF TREES		
	<i>Canopy Shade Tree</i>	<i>Ornamental</i>
Minimum Size	2.0" Caliper (1.25" Residential Street)	1.5" Caliper
Minimum Spacing	25 feet	20 feet
Maximum Spacing	40feet	30 Feet

D. Arterial Median Protection. The border of a landscape median in an arterial street shall be raised with a vertical wall or shall include an inclined splash block of a medium-to-dark earthtone color (see Median Planting detail below).

E. Hardscape. Landscape paving shall be used as a median cover wherever a landscape area is not provided. The hardscape may completely cover a median, or part of a median, that is less than 7 feet in width. Landscape paving may be integrated into a tree corridor or variety combination style, but shall not exceed 40% of the area of such a landscaped median. Landscape paving shall be of an aggregate or paver type and of a medium-to-dark earth-tone color.

G-4 TREE LAWN

A. Landscape Plan. All developments or roadway improvements shall submit a tree lawn landscape plan that meets or exceeds the standards of this Section.

B. Tree Lawn Planting Design Options

- 1. Canopy shade trees shall be planted at 25 to 40 foot intervals (spacing) in the center of all such tree lawn

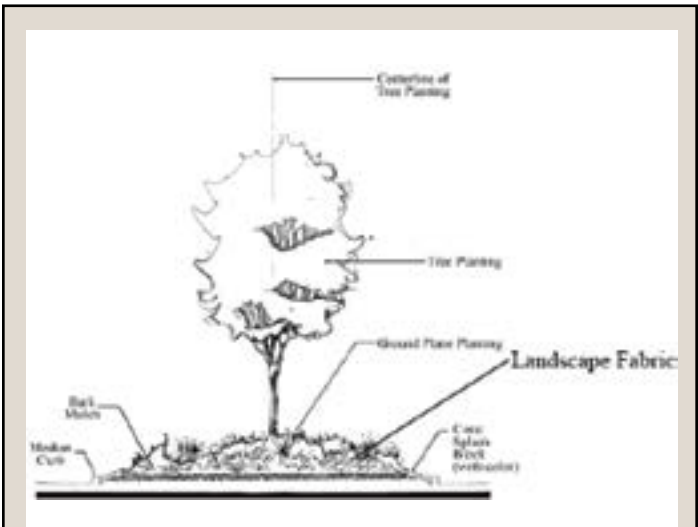

Figure G-1: Example of 12' Median Section

areas whenever the sidewalk is separated from the street by a tree lawn. Whenever the sidewalk is attached to the street, the canopy tree shall be established 2.5 feet behind the sidewalk at 25- to 40-foot spacing, or in tree wells were specified by the Street Standards.

2. Ornamental trees shall be planted in substitution of the canopy shade trees where overhead lines and fixtures prevent normal growth and maturity.
3. The tree lawn ground plane planting design shall consist of turf grass and automatic irrigation system unless otherwise specified in these regulations. Xeriscape design principles should be incorporated whenever appropriate. Within the tree lawn, the ground plane should be attractive but not dominant, uniform, uncluttered, and low in height and growth.
4. Trees must be planted in the center of the tree lawn measured from the front of the sidewalk and back of the curb.
5. No street tree shall be planted closer to the street than 2.5 feet from the back of the curb for ornamental trees and 3.5 feet from the back of curb for large shade trees.
6. Larger maturing trees should be placed 40 feet apart and smaller maturing trees (such as in the Variety/Combination Median style) may be placed 20 feet apart. When space is limited or to achieve certain design effect, closer spacings may be considered.
7. No tree shall be planted closer than 10 feet from any driveway or alley, nor shall a tree be planted in such a manner that its eventual growth cannot be reasonably controlled so as to avoid interference with or obstruction to any improvements installed for public benefit.

C. **Utilities.** Landscape and utility plans shall be coordinated. The following list sets forth minimum dimension requirements for the most common tree/utility separations. Exception to these requirements may occur where utilities are not located in their standard designated locations, as approved by the City. Tree/utility separations shall not be used as a means of avoiding the planting of required street trees.

1. 40 feet between street trees and streetlights. 15 feet between ornamental trees and streetlights. (See figure below.)
2. 10 feet between trees and water or sewer lines.
3. 4 feet between trees and gas lines.
4. 10 feet between trees and fire hydrants
5. Street trees on local streets planted within the 8-foot-wide utility easement may conflict with utilities and should be avoided. Additional conduit may be required to protect underground electric lines.

D. **Visual Clearance or Sight Distance Triangle.** A visual sight distance triangle, free of any structures or landscape elements greater than 2.5 feet in height shall be maintained at street intersections and driveways, and comply with Section 4.3.5 of these Standards.

1. Fences shall not exceed 42 inches in height and shall be of an open design. Fences shall not be permitted in the clear sight triangle described in Section 4.3.5.
2. Deciduous trees may be permitted to encroach into the clearance triangle provided that the lowest branch of any such tree shall be at least 12 feet from grade at maturity.
3. At the intersection of roadways or vehicular access points, no plant material with a mature height greater than 2.5 feet shall be planted within a sight triangle measuring 35 feet along the boundary of each of the intersecting roadways, measured from the point of intersecting curblines, except where engineering standards indicate otherwise.
4. Trees shall be located no closer than 10' to any driveway or alley.

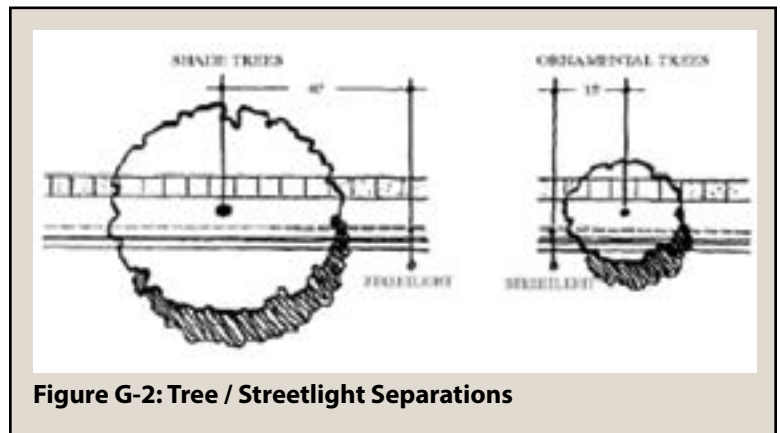

Figure G-2: Tree / Streetlight Separations

G-5 PLANTING GUIDELINES

- A. **Weather, Climate, Soils.** Due to severe climate conditions in Cheyenne, consideration of long-term maintenance is an important element of the initial design of any streetscape. Precipitation is limited to 15 inches per year on average, with extreme temperatures in the 90's in the summer and as low as -20 in the winter. As much as one-third of the rain comes in May and June as heavy downpours. Heavy snows in spring and fall may break tree limbs, coming when trees are in leaf. Mild spring and fall weather is broken by sudden frosts.
- B. **General Planting Considerations.** Severe conditions require careful design and selection of vegetation. Suitable plant lists are available at the Botanical Gardens and Urban Forestry websites. Adaptable plants that have proven hardy are recommended wherever possible. Xeriscape methods are advisable, such as grouping plants with similar water demands together and watering higher-demand plants on a different sprinkler schedule while drought-tolerant plants may be watered by rain or bubbler irrigation. Soil preparation is a critical step in all xeriscape. General planting considerations include the following:
1. Coordinated tree planting sets a rhythm and pattern for the street. By alternating tree types, a sense of enclosure can be achieved while slower growing trees are established.
 2. Gardens of perennials and annuals should be restricted to high-priority areas for maintenance and safety reasons.
 3. Consider utilizing xeriscape principles for high-traffic, low-maintenance, or otherwise dry or difficult areas.
- C. **Streetscape Approval.** The developer shall contact the City Project Manager, Project Engineer, or Construction Manager before work on any City maintained streetscape commences.

G-6 PLANTING STANDARDS

- A. **Projects Governed by Planting Standards.**
1. Public projects such as streets, medians, and tree lawns shall provide for tree planting as a part of the development process. The landscape plan for such projects shall be approved by the City Forestry Department and must adhere to the design objectives, spacing locations, and other requirements with the City.
 2. Private projects shall provide for street tree planting as part of the development process. Street trees shall be located on the public right-of-way and must adhere to the design objectives, spacing, location, and other requirements of the City. These plantings are meant to work as a cohesive standard with the City's current Landscape ordinance. Exceptions can be made for tree plantings in the right-of-way due to utility placement and other variations that would be deemed by the City Engineer to make street trees in the right-of-way unfeasible.
- B. **Specific Standards.**
1. Existing healthy street trees shall be preserved wherever possible. If a tree is removed, mitigation trees of at least equal value as that of the removed tree shall be provided as determined by the City Forester.
 2. New street trees that are part of a new development project and infill plantings shall be at least 1.5 to 2-inch caliper.
 3. Automatic irrigation shall be provided to all trees, shrubs, and turf unless otherwise specified in these regulations.
- C. **Size, Type, and Distribution of Tree Species.**
1. Public tree planting can be accomplished with container trees, balled and burlapped trees or use of a tree spade. Bare-root plantings are not permitted without written permission as determined by the City Forester.
 2. No single species shall make up more than 50% of the total City tree population. The following requirements are for tree species at any one site:

TABLE G-2: TREE STATISTICS	
Number of Trees at Site	Maximum % of any 1 Species at Site
10 to 19	50
20 to 39	33
40 to 59	25
60 or more	15

- 3. The plant palette listed in the 'Adopted Species List' available at the City Forestry Department constitutes the official tree species for Cheyenne. Species other than those included in this list shall not be planted as street trees without written permission of the City Forester.

D. Soil Preparation Requirements.

- 1. All utilities shall be located prior to trenching and shall be protected from damage.
- 2. Trenching around established trees is prohibited within 10' of trunk.

G-7 IRRIGATION STANDARDS

- A. Irrigation systems in any public ROW (which are now or will at some future point be maintained by the City of Cheyenne) must be constructed in accordance with the standards set forth in the current edition of the City of Cheyenne, Parks and Recreation *Standards and Specifications*.
- B. Commercial properties would be advised to utilize commercial-grade irrigation equipment.
- C. The City Engineer reserves the right to require adherence to Irrigation Standards set forth in the City of Cheyenne, Parks and Recreation *Standards and Specifications* on ROW or properties that may have extenuating or special circumstances.
- D. If an irrigation system is dedicated to the City then all components including irrigation meter pits and backflow preventers shall be placed in the public right-of-way or an easement dedicated to the City.

G-8 TURF SEEDING STANDARDS

A. General.

- 1. *Seed Mix*. Shall be approved by the Project Manager, Project Engineer, or Construction Manager based on the activity to take place, planned irrigation method and maintenance to be performed in the area being seeded.
 - a. Pre-approved Dryland Mix (for temporary or permanent unmowed and non-irrigated areas):
 - (1) 44% Fairway Crested Wheatgrass
 - (2) 10% Blue Grama
 - (3) 10% Butte Side Oats Grama
 - (4) 3% Texoka Buffalograss
 - (5) 20% Annual Rye Grass
 - (6) 10% Western Wheat Grass
 - (7) 3% Critana Wheat Grass
 - b. Pre-approved Irrigated Seed Mix (for mowed applications) *Fescue Mix*:
 - (1) 10% Chewing Fescue
 - (2) 10% Creeping Fescue

APPENDIX G

- (3) 10% Hard Fescue
- (4) 10% Sheep Fescue
- (5) 20% Tall Fescue (Regiment II)
- (6) 20% Tall Fescue (Crew Cut II)
- (7) 20% Tall Fescue (Blade Runner)

2. **Seeded Areas.** Seeding is allowed in Tree Lawns where approved by the City, on side slopes of detention ponds to be maintained by the City, and in some temporary dryland applications. No seeding is allowed in medians. All proposed seeded areas are to be specifically approved by the City and shall be of the latest crop.

B. **Submittals.** The developer shall submit certificates showing State, Federal or other inspection showing source and origin of materials to the City.

C. **Materials.**

1. **Seed.** Shall be of fresh, clean, new crop seed composed of the varieties approved by the City with tested minimum percentages of purity and germination clearly labeled on the package. All seed shall be free of *Poa annua* and all noxious objectionable weeds with a maximum crop of .1% and maximum weeds of .1% weeds.
2. **Mulch.**
 - a. For slopes 30% and less: Native grass straw without weed seed and consisting of grasses as specified for seeded application.
 - b. For slopes 30% and greater, and inaccessible areas: Hydromulch using Weyerhaeuser "Silva-Fiber" mulch or approved equal. The wood cellulose fiber for hydraulic mulching shall not contain any substance or factor which might inhibit germination or growth of grass seed. It shall be dyed a green color to allow metering of its application.
 - c. Tackafier use Teratack III, or approved equal.
3. **Netting.** For slopes greater than 30%, use Soil Saver jute netting, or approved equal. Netting to be stapled with No. 11 gauge steel wire forged into a 6-inch long U-shape and painted for visibility in mowed areas. Netting must be placed so it does not cause a problem for mowers.
4. **Fertilizer.** Use a fertilizer with a formula of 18-46-0 on all areas to be seeded.
5. **Inspection.** Inspect finish grade and trim where needed to obtain finish grades of 1 inch below adjacent pavements. Verify positive drainage away from all structures. Verify or complete removal of rock and debris larger than 1 inch from all areas to be seeded.

D. **Execution.**

1. **Fertilizer.** Apply 8 pounds per 1,000 square foot of seeded area and rake lightly into top 1/8 (0.12) inch of soil just prior to seeding operation.
2. **Seeding.**
 - a. Do not sow seed in windy weather or when ground is frozen or otherwise untillable.
 - b. Use Brillion type drill or hydraulic seeding methods. Drill seed in manner such that after surface is raked and rolled, seed has ¼ (0.25) inch of cover.
 - c. Hydraulic seeding will be used in areas that are not accessible for machine methods. A hydraulic pump capable of being operated at 100 gallons per minute and at 100 pounds per square inch pressure should be used. The equipment shall have an acceptable pressure gauge and a nozzle adaptable to hydraulic seeding requirements. Storage tanks shall have a means of agitation and a means of estimating the volume used or remaining in the tank. Do not seed and mulch in the same operation.
 - d. Rates: Dryland Mix—30 pounds pure live seed per acre. Irrigated Mix—10 pounds per 1000 sq. ft.
3. **Mulching.**
 - a. Native Grass Mulch: Apply at a rate of 2 tons per acre. Mulch seed beds within 24 hours after seeding.
 - b. Hydromulching: Wood cellulose fibers must become evenly dispersed when agitated in water. When sprayed

uniformly on the soil surface, the fibers shall form a blotter like ground cover which readily absorbs water and allows infiltration to the underlying soil. Cellulose fiber mulch shall be added with the proportionate quantities of water and other approved materials in the slurry tank. All ingredients shall be mixed to form homogenous slurry. Using the color of the mulch as a metering agent, spray-apply the slurry mixture uniformly over the seeded area. Apply with tackafier used at a rate of 120 pounds per acre. Unless otherwise ordered for specific areas, fiber mulch shall be applied at the rate of 2,000 pounds per acre. Hydraulic mulching shall not be performed in the presence of free surface water resulting from rains, melting snow or other causes.

4. *Netting.* Net areas over 30% slope. If contractor fails to net and subsequent soil erosion occurs, contractor shall re-establish finish grade, soil preparation, seed bed and apply netting at no cost to the City of Cheyenne.
 5. *Watering.* Immediately after seeding and mulching, water seeded area slightly, but with care so that no erosion takes place and no gullies are formed. Water a minimum of three times a day and keep seeded area moist until turf is established. Sloped areas should be hand watered until turf is established to prevent erosion; water these areas more often but for shorter periods of time.
 6. *Clean Up.* Remove all hydromulch and other mulch materials from all plant materials, fences, concrete and other areas except for seed bed.
 7. *Protection.* Provide and install barriers as required to protect seeded areas from pedestrian and vehicular damage. Provide signage if needed.
- E. **Guarantee/Warranty.** Warrant seeded areas for consistency and completion of coverage. Re-seed as needed to ensure a successful stand of grass that is acceptable to the City. Once a vigorously growing stand of grass is achieved with a minimal amount of weeds, the request for Construction Acceptance may be made.

G-9 FINE GRADING AND SOIL PREPARATION STANDARDS

A. General.

1. Soils tests conducted by a certified or qualified soils testing lab must be completed and submitted to the City for review; recommendations in the lab reports shall be followed in all cases. Generally this will include soil amendment and fertilizer recommendations; in some cases, all new topsoil will be required.
2. If the site is undisturbed, topsoil is to be stripped to a 6-inch depth, or to topsoil depth as determined by field inspection. Stockpile and re-spread stripped topsoil over landscape areas after rough grades are established. If site has been disturbed, or sufficient topsoil is not available, topsoil is to be imported to achieve 6-inch depth in all landscaped areas.

B. Submittals.

1. *Soil Amendment.* Submit sample and written confirmation from supplier of material composition including: percent organic matter, salts, nutrient composition and trademark. Sample is to be representative.
2. *Topsoil.* Submit sample and written confirmation from supplier of material composition including: percent organic matter, salts, and nutrient composition. Sample is to be representative.

C. Materials.

1. *Soil Amendment.* Certified organic material or approved equal. A high quality composted material containing a minimum of 50% organic matter. The mixture shall be free from clay subsoil, stones, lumps, plants or roots, sticks, weed stolons, seeds, high salt content and other materials harmful to plant life. The compost shall be coarsely ground with an even composition and have an acidity in the range of pH 5.5 to pH 7.0. All material shall be sufficiently composted such that no material used is recognizable.
2. *Topsoil.* Must be taken from a well drained, arable site and shall be reasonably free of subsoil, stones, clods, sticks, roots and other objectionable extraneous matter or debris. No stones or other materials over 2 inches in size shall be allowed. Topsoil shall contain no toxic materials and have an acidity in the range of pH 5.5 to pH 8.5.
3. *Fertilizer.* Balanced fertilizer with a chemical analysis of 10-25-12.

D. Inspection.

1. Locate all utilities prior to trenching and protect from damage.
2. Accept rough grading from other contractors per approved plans. Rough grade inspection is to allow for 6-inch minimum depth of topsoil and specified soil amendments as part of the fine grading work.

E. Execution.

1. Protect existing trees, landscaping, existing structures, fences, sidewalks, utilities, paving, curbs, and other features remaining as final work during construction. Contact the City Forester for proper procedures on how to implement tree protection.
2. Grub and remove unsuitable woody and rock material present in the surface grade.
3. Take precautions to accommodate proper drainage and flow during and after grading and soil preparation.
4. Apply herbicide to areas where noxious weed beds have been established and/or where seed mix is to be planted. Herbicide must be applied by certified contractors at the rate recommended by the manufacturer after proper notification has been done in accordance with chemical applicator's standards. Precautions must be taken to avoid drifting of spray onto other properties; spraying shall not be done in breezy conditions. Harm to plant material not designated for herbicide application shall be replaced by the contractor.
5. Rip to 6-inch depth with agriculture subsoiler in all areas to receive plantings. Contact City Forester regarding acceptable procedures to not disturb existing roots or established trees. Remove all objects greater than 2 inches in diameter.

F. Application.

1. Spread 6 inches topsoil over entire landscaped area, except in the dripline of existing trees, and grade to smooth and even lines. Establish swales and drainage as required per plans.
2. Evenly distribute soil amendment at rate of 3 cubic yards per 1,000 square feet of area, or 1-inch depth over the entire area to be prepared; alter rate if soils test recommends otherwise. Till amendments into top 6 inches of soil. Compact to a firm, but not hard density (80% of Standard Proctor Density at 2% optimum moisture). Evenly distribute triple superphosphate fertilizer at the rate of 15 pounds per 1,000 square feet; modify type and rate if soils test recommends otherwise.
3. Trim finish grade elevations adjacent to paved areas to 1 inch below pavement finish grade.

G-10 STREETScape MAINTENANCE STANDARDS

- A. **Purpose.** The purpose of this section is to ensure a consistent, high-quality appearance for all streetscapes, whether maintained by the City, its agents, or by private developers, businesses, or individuals. Given the high visibility of City streetscapes, the public is able to observe maintenance practices in the field as well as the results of that maintenance. The public perception of a well maintained landscape is promoted by practices which benefit the health of the landscape materials and achieve a neat, well-cared-for appearance. Quality maintenance is a function of workmanship, funding, and technique. These standards will ensure that all streetscapes are cared for in a manner which reflects the high esteem that citizens have for these important public spaces. Generally, all landscaping shall be maintained in a healthy condition throughout the growing season. A neat and attractive appearance is essential. Irrigation systems, structures, and sidewalks shall be maintained to represent the original integrity of the design and installation.
- B. **Planting and Maintenance Standards.** The practices of the City of Cheyenne Forestry Department will serve as the standard for planting and maintenance for all trees in the public rights-of-way; Forestry Department standard practices apply whether the work is performed for the City contractually, by the City, or by private entities or individuals.
- C. **Permit.** As per city code, a permit must be obtained from the City Forestry Division before any planting, pruning, removal, or destruction of any tree, shrub, or hedge in or upon the public right-of-way. All work requiring a permit shall be conducted in a manner as to cause the least possible interference with or annoyance to others. Pedestrian and vehicular traffic shall be

allowed to pass through the work areas only under conditions of safety and with as little inconvenience and delay as possible.

- D. **Maintenance.** Maintenance of ground-level streetscapes shall be the responsibility of the adjacent property owner.
1. Mowing shall not interfere with the use of streets and sidewalks and shall meet the provisions of the City nuisance and weed ordinance.
 2. Turf should be maintained within the designated planting area, and mulch, either wood or rock, should be free of weeds.
 3. Dead plants should be replaced, clippings and trash removed, and mulch and plants replaced as they diminish and die off.
 4. Landscaped area should be kept as similar to its initial appearance as possible.
 5. Irrigation times and installations should occur per City requirements.

G-11 ESTABLISHMENT MAINTENANCE FOR NEWLY PLANTED TREES.

- A. **New Residences.** Information regarding street tree planting and maintenance requirements can be obtained from the City Forester's office.
- B. **Establishment Maintenance Guidelines.**
1. Maintain irrigation standards. Newly planted trees require additional irrigation for 2 to 3 years. Particularly during the first year this can exceed water demand of turf. New trees should receive 1 inch of irrigation per week during the first growing season, applied over the root system. Normal turf irrigation is generally adequate (1 inch per week) for the second and third year. 15 inches of supplemental irrigation per growing season is adequate after establishment. Irrigation times should occur per City requirements.
 2. Insure irrigation rates for new trees in turf areas are adequate during establishment even when that is greater than water demand for turf.
 3. Mulch newly planted trees over the root system with 3 inches of organic mulch. Trees in turf zones shall be planted in 4-foot diameter rings.
 4. Inspect new plantings on a regular basis and remove dead, broken and diseased branches.
 5. Remove sprout growth from stems and root collars early in the growing season.
 6. Evaluate mulch on an annual basis. Re-mulch trees to maintain a maximum of 3-inch deep mulch cover. Keep mulch 3 inches away from the tree trunk.
 7. Maintain tree rings in turf zones as weed free.
 8. Monitor insect and disease levels and control measures implemented when necessary following Integrated Pest Management (IPM) practices.
 9. Remove all nursery or other tags from plants and landscape materials.
 10. Remove tree wrap and stakes the next spring season after planting.

NOTE: See "Adopted Species List" available at the City Forestry Department and online at <http://www.cheyennetrees.com/>

APPENDIX H [RESERVED]

APPENDIX I [RESERVED]

APPENDIX J [RESERVED]

APPENDIX K – AMENDMENTS

The following is a log of amendments to this code including text and zoning map amendments. A copy of the official ordinance authorizing the amendments is on file with the City.

DATE	ORD. NO.	TEXT AMENDMENT OR ZONE CHANGE	AMENDED SECTIONS OR NEW ZONING DISTRICT
6/11/2012	3949	Zone Change	Diamond Estates 3rd, MUB to MR-2
7/9/2012	3953	Zone Change	Saddle Ridge 4th, HR-2 to MR-2
7/9/2012	3954	Zone Change	TCI Tire, CB to LI
8/13/2012	3956	Zone Change	Meridian Bank & Trust, MUR to MUB
10/8/2012	3959	Zone Change	Chaplin Park, MR-1 to MUB
10/8/2012	3960	Zone Change	Family Dollar, MUB to CB
10/8/2012	3961	Zone Change	Taco Johns, MUB to CB
12/20/2012	3963	Zone Change	City Parking Lot, MR-1 to MUB
1/14/2013	3964	Zone Change	2100 Pioneer, P to CBD
2/11/2013	3968	Zone Change	Johnson, CB to MUB
2/11/2013	3969	Zone Change	Diamond Estates 4th, HR-2 to MR-2
3/11/2013	3970	Zone Change	Storey Blvd Extension, P to NB
4/8/2013	3971	Zone Change	Plains Industrial, A-2 to HI
5/13/2013	3972	Zone Change	21 Max, MR-1 to NR-3
5/13/2013	3973	Zone Change	2114 Pioneer, P to CBD
7/8/2013	3985	Zone Change	Hutchins, CB to HI
7/8/2013	3986	Zone Change	Cooley, CB to MUB
7/22/2013	3987	Zone Change	Green House Data, HI to CB
7/22/2013	3988	2013 Annual Review Amendment 1 - "High Priority Quick Fixes"	Table 1-1, Summary of Review Authority (Variances); Figure 4-18, Corner Sight Distance; Section 4.3.6.c, Access Width; Table 4-13, Lot Access Width (Note 2 deleted); Table 4-17, Minimum Pavement Sections (numeric changes); Table 5-1, Zoning District Uses (Apartments in NR-2 & NR-3); Sections 5.1.5a and b (certain rear setbacks changed from 25' to 20'); E-8 (source added).
8/12/2013	3989	Zone Change	Swan Ranch II Annexation, LI & PUD (County) to LI & PUD (City)
8/12/2013	3990	Zone Change	Kornegay, MR-2 to CB
8/12/2013	3993	Zone Change	Polk, AG to LI
9/9/2013	3996	Zone Change	Cheyenne Housing Authority, MUB to P
9/9/2013	3997	Zone Change	Terre Pont, A-1 & MU (County) to CB
10/14/2013	4000	Animal Care/Clinics/Kennels	Table 5-1, Zoning District Uses (Animal Care - Hospital/Clinic Conditional in NB & MUB, Animal Care/Kennel Permitted in LI)
10/28/2013	4001	Annexations	Repealing & re-enacting Sec. 2.4.2 to refer to Wyoming Statutes only.
1/13/2014	4014	Zone Change	Lots 15 & 16, Block 17, Crest Ridge, 4th (Pronghorn Apartments)
2/10/2014	4017	Election Signs	Add subsections 15 & 16 to 6.5.5.b, Exemptions
2/10/2014	4018	Zone Change	Lot 8, Block 223, Original City, LI to MUR
2/24/2014	4020	Administrative Adjustments	Amending Sec. 2.3.4.b.3 to increase the amount of allowable administrative adjustment from 10 percent to 50 percent

APPENDIX K – AMENDMENTS, CONTINUED

The following is a log of amendments to this code including text and zoning map amendments. A copy of the official ordinance authorizing the amendments is on file with the City.

DATE	ORD. NO.	TEXT AMENDMENT OR ZONE CHANGE	AMENDED SECTIONS OR NEW ZONING DISTRICT
2/24/2014	4021	Urban Lofts	Adding Urban Loft Building to Sec. 1.4.4.a, Residential Uses, Table 5-1, Zoning District Uses, and other applicable sections of Articles 5 and 6
3/10/2014	4022	Zone Change	South 79 feet of Lot 8, Block 311, Original City, CB to MUR
3/10/2014	4023	Zone Change	Lot 1, Block 1, Public Works Addition, CB to LI
5/12/2014	4024	Front Setback Alternative Compliance	6.6.3.d: Alternative Compliance. Detached Dwelling Lot Types and Semi-Attached Dwelling Lot Types may propose a principal building front setback of 15' when the standards in <i>Compact and Mixed-Density Neighborhood Design</i> (6.6.4) and access width standards in Table 4-13 are met. In existing neighborhoods the front setback shall not be less than the context of adjacent detached or semi-attached structures.
6/23/2014	4028	Animal Clinics in CBD	Table 5-1, Zoning District Uses (Animal Care - Hospital/Clinic Conditional in CBD)
7/28/2014	4032	Zone Change	Del-Van Storage, MU (County), MUB, & MR-1 to MUE (City)
7/28/2014	4034	Landscaping Irrigation	Adding 6.3.7.f.4, to allow an exception to irrigation requirements for seeded drought tolerant grass ground covers in LI & HI zones (Sections G-4.B.3 and G-6.B.3 as well)
8/11/2014	4036	Zone Change	US 30 Business Plaza, AR (County) to CB (City)
8/25/2014	4039	Landscaping Point Values	Amending Tables 6-8, 6-9, 6-11, and 6-12
9/8/2014	4040	Zone Change	Diamond Estates, 5th Filing, MR (County) to MR-2 (City)
10/13/2014	4043	Zone Change	Original City, Block 509, Lot 7 & 8, MR-1 to MUB
12/8/2014	4047	Zone Change	Plains Industrial Park, 3rd Filing, AG (County) to HI
1/12/2015	4052	Zone Change	Carter Cottages, HR (County) to HR-2
1/12/2015	4054	Zone Change	Thomas Heights, A-1 (County) to AR / A-1 (County) and AR to MR-2
1/12/2015	4051	Zone Change	Schrader Funeral Home, MUB to MUR
2/23/2015	4056	Zone Change	The Bluffs, 10th Filing, LR (County) and LR-2 to MR-2
2/23/2015	4057	Zone Change	Triumph Addition, 2nd Filing, CB to MUB
3/9/2015	4059	Zone Change	Chukker Ridge, 2nd Filing, A-2 (County) to MR-2
3/9/2015	4061	Zone Change	Koduri Properties, MR (County) to MUB
3/9/2015	4063	Zone Change	Torres Property at Land Court, MR (County) to MR-1 (City)
6/3/2015	4069	Notification Boundary	Qualifying area for notification mailings for Sections 2.1.4, 2.2.1, 2.2.2, 2.2.4, & 2.3.2.
6/8/2015	4076	Zone Change	Waterford Square Annexation, LI (County) to NR-3 & CB (City)
6/8/2015	4075	Zone Change	300 East 16th Street - Verizon Wireless, CB to MUB
8/15/2015	4082	Zone Change	Cheyenne Business Parkway, 8th Filing, HI to AG
8/15/2015	4083	Zone Change	Cheyenne Business Parkway, 9th Filing, HI to LI and HI to AG
8/15/2015	4084	Text Amendment	Billboards zoning district clarification
9/2/2015	4085	Text Amendment	Conditional Use Approval Applicability
9/2/2015	4086	Text Amendment	Removal of Sunset Clause on Administrative Adjustments

APPENDIX K – AMENDMENTS, CONTINUED

The following is a log of amendments to this code including text and zoning map amendments. A copy of the official ordinance authorizing the amendments is on file with the City.

DATE	ORD. No.	TEXT AMENDMENT OR ZONE CHANGE	AMENDED SECTIONS OR NEW ZONING DISTRICT
9/2/2015	4087	Text Amendment	Drainage Impact Studies rewrite, updating Defined Terms, and repealing Appendix H
9/21/2015	4091	Zone Change	Holdrege’s Addition, 4th Filing, MR-1 to MUB
9/21/2015	4092	Zone Change	L1, B1 Lowe Subdivision and L1&2, B1, Good Addition, NB to CB
9/21/2015	4093	Zone Change	Heiduck Addition, LI (County) to LI (City)
9/21/2015	4094	Zone Change	Saddle Ridge, 7th Filing, CB to MR-2
9/21/2015	4096	Zone Change	Saddle Ridge, 8th Filing, A-1 (County) to MR-2 (City)
9/21/2015	4098	Zone Change	Coulson Addition, MR (County) to MR-2 (City)
10/16/2015	4100	Zone Change	RKRR Addition, MR-2 to MUB
12/23/2015	4106	Zone Change	522 Van Lennen Avenue, P to MUB
12/23/2015	4107	Zone Change	1605 E 23rd Street, CB & MR-1 to MUB
12/23/2015	4108	Zone Change	4015 N College Drive, Dry Creek Business Park, MR-2 to CB
1/5/2016	4109	Text Amendment	Increasing Maximum Total Lot Coverage Allowed in Some Residential Lot Types
1/5/2016	4110	Text Amendment	Accessory Dwelling Units
1/16/2016	4112	Zone Change	1315 E 21st Street, MR-1 to MUB
1/16/2016	4115	Zone Change	Summit Park, A-1 (County) to NR-3 (City)
2/12/2016	4119	Zone Change	Campstool Addition, 3rd Filing, LI to HI
4/18/2016	4123	Zone Change	Block 349, Original City, LI to MUB
4/18/2016	4124	Zone Change	Block 396, Original City, CB to MUB
5/14/2016	4128	Zone Change	Braden Homesites, AR (County) to MUB
6/22/2016	4135	Zone Change	E 27th St and Evans Ave., Block 76, Original City, MR-1 to NR-3
7/1/2016	4137	Zone Change	Portion of Lot 9, Block 2, Parsons Addition, MR (County) to MR-2
7/18/2016	4148	Zone Change	Lummis/Read, LI (County), A-2 (County), and PUD (County) to P and AG
7/18/2016	4149	Zone Change	South Park Estates, 9th Filing, MR-1 and MR-2 to NR-3
8/13/2016	4152	Zone Change	USI Plaza, MR-1 to NR-2
10/14/2016	4156	Zone Change	Habitat 13th Street, CB to MR-2
10/14/2016	4158	Zone Change	Southwest Industrial Park, LI (County) to LI (City)
11/18/2016	4160	Zone Change	2514 Dell Range Blvd, MUB to CB
1/14/2017	4163	Zone Change	Dell Range Retail Center, MUB to CB
2/18/2017	4164	Text Amendment	UDC Section 2.1.5 Lot Line Adjustment Plat Waiver
2/18/2017	4166	Zone Change	Tract 71 and portions of Tracts 70 & 72, Allison Tracts, 2nd Filing from MR (County) to MR-2
3/21/2017	4169	Text Amendment	Consolidating LR-1 and LR-2 into LR, MR-1 and MR-2 into MR, and HR-1 and HR-2 into HR
4/14/2017	4172	Zone Change	Tyrell Addition, 2nd Filing, Lot 1, Block 1 and Lot 1, Block 2, CB to LI
5/12/2017	4174	Zone Change	Grand Mesa, NR-2 to NR-3
5/12/2017	4176	Zone Change	Th Bluffs, 11th Filing, LR (County) to MR (City)
6/19/2017	4181	Text Amendment	Clarifying Special Use Approval
7/14/2017	4188	Zone Change	1920 Dillon Ave, LI to MUR

APPENDIX K – AMENDMENTS, CONTINUED

The following is a log of amendments to this code including text and zoning map amendments. A copy of the official ordinance authorizing the amendments is on file with the City.

DATE	ORD. No.	TEXT AMENDMENT OR ZONE CHANGE	AMENDED SECTIONS OR NEW ZONING DISTRICT
7/14/2017	4187	Zone Change	North College Subdivision, MR to NR-3 and P
8/19/2017	4192	Zone Change	Lincoln Valley Tracts, a portion of Tract 1, AR (County) to AR (City)
8/19/2017	4193	Zone Change	South Park 10th Filing, CB to LI
8/19/2017	4194	Zone Change	Converse Place Apartments, NB to NR-3
9/2/2017	4197	Zone Change	Sunnyside Addition, MU (County) to MUB (City)
9/16/2017	4202	Zone Change	Mission Village, MR (County) to MR (City)
9/16/2017	4199	Text Amendment	Allowing Utility Stations in AG, AR, and AD Zones
9/16/2017	4200	Text Amendment	Allowing Home Occupations Within the NB, CB, CBD, LI, and HI zones.
9/29/2017	4203	Text Amendment	Defining Through Lot and Clarifying Setbacks For Accessory Buildings on Through Lots
10/13/2017	4204	Zone Change	Interior Heights, 2nd Filing, A-1 (County) to AR (City)
11/18/2017	4207	Zone Change	107 W 8th Avenue, MR to CB
11/18/2017	4208	Zone Change	409 W 4th Street, HR to CB
11/18/2017	4210	Zone Change	Swan Ranch Rail Park, 11th Filing, Swan Ranch Rail Park PUD to LI
1/12/2018	4214	Text Amendment	Creating Impoundment Yards as a land use category and allowing the use in the LI, HI, and MUE zones as a use by right, and in the MUB and CBD zones as a Conditional Use
2/22/2018	4217	Zone Change	Whitney Ranch, 1st Filing, from A-1 (County) to MR and MUB
2/22/2018	4220	Text Amendment	Clarifying Group Dwelling, Nursing Home, and Assisted Living use definitions and permissions
5/19/2018	4224	Zone Change	Lot 14, Block 5, Replat Homestead Addition, First Filing, MR (County) to NR-2
5/19/2018	4226	Zone Change	Saddle Ridge, 13th Filing, A-1 (County) to MR and P
5/19/2018	4227	Zone Change	510 W. 29th Street, Conditional MUR to NB
7/14/2018	4238	Zone Change	Lots 1-2, Block 1, Simpson Estates, MUB to CB
7/14/2018	4239	Zone Change	North Gate Village, MR to MUB
9/29/2018	4244	Zone Change	6110 Brimmer Road, LR (County) to LR (City)
9/29/2018	4245	Text Amendment	Allowing the SD1 Semi-Attached Dwelling / Large Lot lot type in the MR zone
9/26/2018	4249	Zone Change	Portion of the W1/2 W1/2 Section 17, T14N, R66W, of the 6th Principal Meridian, County A-1 and Rural Residential to MUR
12/10/2018	4250	Zone Change	Lots 9-12, Block 9, Meadowbrooke Park Subdivision, HR to CB
12/10/2018	4251	Zone Change	Lot 1, Block 1, Plaza Del Range, 2nd Filing Subdivision, CB to HR
1/22/2019	4256	Zone Change	Lot 1-2, Block 534, Original City, MR to NR-2
1/22/2019	4257	Zone Change	A parcel of land consisting of Tract B, Overland Trails 5th Filing Subdivision, Overland Trails PUD to LI
1/22/2019	4258	Text Amendment	Allowing Director to approve parking above the maximum, based on parking study
3/11/2019	4262	Zone Change	Lot 4, Block 2, Swan Ranch Rail Park Third Filing, County Swan Ranch PUD to City Swan Ranch PUD (Ord. 3989)
3/11/2019	4263	Zone Change	Hutchins Corner 2nd Filing: Lots 4 and 5, CB to LI
4/16/2019	4265	Zone Change	Lots 1, 2, 5, 6, 7, and 8, Block 1, and Lots 2, 3, and 4, Block 2, Countryside Addition: County AR to CB

APPENDIX K – AMENDMENTS, CONTINUED

The following is a log of amendments to this code including text and zoning map amendments. A copy of the official ordinance authorizing the amendments is on file with the City.

DATE	ORD. No.	TEXT AMENDMENT OR ZONE CHANGE	AMENDED SECTIONS OR NEW ZONING DISTRICT
6/4/2019	4271	Zone Change	FW Subdivison: County CB to CB
7/17/2019	4278	Text Amendment	To allow smaller wireless communication faciiliites and generally update the Wireless Communi-cation Faciliites section of the Unified Development Code
8/17/2019	4280	Text Amendment	Electronic Message Center Allowances
8/17/2019	4283	Text Amendment	Entertainment Uses
1/30/2020	4293	Zone Change	N1/2 of Lot 4, Williams Subdivision: County LR to LR
4/13/2020	4301	Zone Change	Tract of Land Generally Located West of Westland Road at Crow Creek: County LI to P
4/13/2020	4302	Zone Change	Lots 5-8, Block 271, Original City, Cheyenne: LI to MUB
4/13/2020	4303	Text Amendment	To reduce the required frontage of Lot Type DD7 from 48-feet to 40-feet and from 60-feet to 45-feet on corner lots.
6/8/2020	4309	Text Amendment	To define and Clarify the purpose of remainder lots.
6/8/2020	4310	Text Amendment	To modify time limits associated with temporary uses.
6/8/2020	4311	Text Amendment	To modify posted notice requirements for site plans and administrative approvals, clarify pro-cedures for modification of site plans, modify authority to initiate text amendments. and modify criteria for variance approval.
7/13/2020	4317	Zone Change	Lots 8-11, Block 42, Mountview Park, 6th Filing: LR to MUR
7/13/2020	4318	Zone Change	Lots 6-8, except that fractional part of said Lot 8 belonging to and a part of the R/W of the Colo-rado And Southern Railway Company, Block 225, Original City, Cheyenne: LI to MUB
7/27/2020	4319	Zone Change	A poetion of the SE1/4 of Section 33, T.14N., R.66W., 6th P.M: CB to MUB
8/10/2020	4321	Zone Change	Lots 1 and 2 and a portion of a 20 foot vacated alley being adjacent to and west of said Lots I and 2, Block 1, Prairie Hills Addition: County MU to MUB
10/12/2020	4326	Text Amendment	To create the support services zone district and establishing design criteria.
11/9/2020	4329	Zone Change	Lot 3, Block 4, Country Club Estates Second Filing: HR to CB
11/9/2020	4330	Zone Change	Lot 1, Block 2 and Lot 1, Block 3, Back 40 Subdivision, Second Filing: MUB to CB
11/9/2020	4332	Text Amendment	To define, establish permissibility, and create specific use standards for the use “Emergency Shelter”.
1/11/2021	4338	Zone Change	A Portion of the North Half of the Southwest Quarter of the Northwest Quarter (N½SW¼NW¼) of Section 20, Township 14 North, Range 66 West of the 6th P.M.: County A-1 Agricultural and Rural Residential to P
1/11/2021	4339	Text Amendment	To define, establish permissibility, and create specific use standards for the use “Mini Storage”.
2/8/2021	4342	Zone Change	Lot 1, Block 2, Bison Business Park: County A-1 to HI and Lot 1, Block 1, Bison Business Park: County A-1 to AG
2/8/2021	4343	Zone Change	Lot 1, Block 1, South Cheyenne, Second Filing: LI to MR
2/8/2021	4344	Zone Chnage	Lots 7 and 7 1/2, Block 4, Lake Minnehaha Resubdivision and a portion of a 16 foot vacated alley adjacent to and north of said lots: MR to CB
3/8/2021	4345	Text Amendment	Amending Section 5.8.4, Fences.
3/8/2021	4346	Text Amendment	Amending the definition of Dwelling Unit and creating the definition for Family Unit.
4/12/2021	4352	Zone Change	Lots 9, 10, 11, and 12, Block 1, Holmes Corner: CB to MUB
4/12/2021	4353	Text Amendment	Amending Section 6.6.3.b.1, Encroachments

APPENDIX K – AMENDMENTS, CONTINUED

The following is a log of amendments to this code including text and zoning map amendments. A copy of the official ordinance authorizing the amendments is on file with the City.

DATE	ORD. No.	TEXT AMENDMENT OR ZONE CHANGE	AMENDED SECTIONS OR NEW ZONING DISTRICT
4/12/2021	4355	Zone Change	Land located north of Dell Range Blvd and West of Whitney Road: County A-2 to MR
4/12/2021	4357	Zone Change	Property Generally Located North of Dell Range Blvd and East of Griffith Avenue: County MR to MR
5/10/2021	4359	Zone Change	Northwest of and adjacent to the intersection of Dell Range Blvd and Whitney Road: County A-2 to AG
5/24/2021	4363	Text Amendment	Amending Section 5.1.5.d Lot Type MD1 and MD2 to allow a maximum of 80% lot coverage and 5.6.1.d Lot Types P-CV1, P-VC2 and P-VC3 to allow a maximum of 80% lot coverage.
6/14/2021	4371	Text Amendment	Amending Section 1.3.7 Fees
6/14/2021	4373	Zone Change	Land located north of Pershing Blvd and West of Christensen Road: County A-1 to MR
6/14/2021	4375	Zone Change	Lot 1, Block 2, Lot 1, Block 3, and Lot 2, Block 4, Bison Business Park, 2nd Filing: County A-2 to AG; Lots 1 and 2, Block 1, Bison Business Park, 2nd Filing: County A-2 to LI; Lot 1, Block 4, Bison Business Park, 2nd Filing: County A-2 to HI
6/28/2021	4382	Text Amendment	To create the Urban Use Overlay district and establishing design criteria.
7/26/2021	4388	Zone Change	Lot 1, Block 1, Meadowlark Estates, 2nd Filing: County MU to CB; Lots 2-7, Block 1 and all of Block 2, Meadowlark Estates, 2nd Filing: County LR to LR; All of Block 3, Meadowlark Estates, 2nd Filing: County LR to MR
7/26/2021	4391	Zone Change	Lot 1 and 2, Block 1, Equipoise Addition: MR to NR-2
7/26/2021	4392	Text Amendment	To create Public Safety Fees.
9/13/2021	4394	Zone Change	Lots 7-18, Block 3, Miller Addition: MR to NR-2
9/27/2021	4395	Text Amendment	To clarify and better facilitate Cottage Lot development.
10/11/2021	4397	Zone Change	Lots 1-23, Block 1; all of Block 2; all of Block 3; all of Block 4; all of Block 5; all of Block 6; and Lots 1-17 and 19, Block 7, Whitney Ranch 4th Filing: AG to MR; Lot 1, Block 8, Whitney Ranch 4th Filing: AG to HR; Lots 24 and 25, Block 1; and Lot 18, Block 7, Whitney Ranch 4th Filing: AG to MUB; Lot 2, Block 8, Whitney Ranch 4th Filing: AG to CB
10/25/2021	4398	Text Amendment	Clarification to the interpretation of Lots and amend accessory building regulations.
10/25/2021	4399	Text Amendment	Modifying the density standards of UDC 5.1.5.d “Multi-dwelling Buildings (Apartment)” Lot Types
11/8/2021	4403	Zone Change	Tract 1, Park Estates, 4th Filing: County LR to MR
11/22/2021	4404	Text Amendment	Modifying Articles 2.1 and 2.2 regarding posted and published notice requirements for divisions of land and zoning applications
12/13/2021	4407	Zone Change	Land located Northeast of the intersection of Old Happy Jack Road and Westland Road: County LI to LI
12/13/2021	4408	Zone Change	Lot 13, Block 5, Westgate Addition (except the north 2.47’ to State Highway: HR to CB
1/10/2022	4409	Text Amendment	Creating the definitions, ‘Functional Turf’ and ‘Non-functional Turf’ and amending various sections of Article 6
2/14/2022	4415	Zone Change	South 1/2 of Lot 5, Block 486, Original City: CB to MUB
3/14/2022	4417	Text Amendment	Amending the permissibility of various uses within Table 5-1: Zoning District uses
3/14/2022	4419	Zone Change	Tract 1, H&B Tracts: County MU to AG
3/14/2022	4420	Zone Change	Tracts 20-22, Rocky Mountain Industrial Park Addition Third Filing; and Lots 1-2, Block 1, Rocky Mountain Industrial Park Fifth Filing: CB to HI

APPENDIX K – AMENDMENTS, CONTINUED

The following is a log of amendments to this code including text and zoning map amendments. A copy of the official ordinance authorizing the amendments is on file with the City.

DATE	ORD. No.	TEXT AMENDMENT OR ZONE CHANGE	AMENDED SECTIONS OR NEW ZONING DISTRICT
3/28/2022	4423	Text Amendment	Repealing UDC 5.4.7, UU - Urban Use Overlay District, and creating UDC 5.6.9, UU - Urban Use Overlay District
4/11/2022	4425	Text Amendment	Creation of UDC 6.3.10 - Common Landscape Plan and associated definitions
5/9/2022	4432	Zone Change	Lot 1, Block 1, Interior Heights, 4th Filing: AR to Harmony Valley PUD
6/13/2022	4442	Zone Change	Lot 1, Dell Range Marketplace, 3' Filing: MUB to CB
6/27/2022	4449	Zone Change	West Edge District: MUB, MUR, LI, and CB to MUB with the UU Overlay
7/11/2022	4450	Text Amendment	Creation of the definition for Data Center and modification to other Industrial Use definitions. Additions of Data Center and its permissibility to Table 5-1: Zoning District uses
9/12/2022	4457	Zone Change	Lot 1, Block 1 Comea Subdivision, 2nd Filing: LI to CB
9/26/2022	4464	Zone Change	Lots 3 and 4, Block 17 and Lots 1 and 2, Block 16 and all of Moran Avenue adjacent thereto, Frontier Gardens 3fl Filing: HR to CB
9/26/2022	4465	Zone Change	Lot 1 and Lot 1 1/2 , Block 18, Re-subdivision of Lake Minnehaha Addition: MR to NR-2
10/10/2022	4468	Zone Change	SV2 of the SV2 of Tracts 27 & 28 Sunnyside Addition, 2nd Filing plus (Book 1345, Page 800, 8640 square feet) vacated Monroe Avenue between said S'2 SV2 tracts and Cox Subdivision Lot 6, Block 2; and Lots 4 and 5, Block 4, Foxcrest Subdivision: MUB to CB
11/14/2022	4474	Zone Change	A parcel of land being situated in a portion of north half of Section 23, Township 13 North, Range 67 West of the Sixth Principal Meridian: County CB and County A-2 to CB, AG, and LI
12/12/2022	4476	Zone Change	Lot 1, Block I, Pat Griffm Park, Second Filing: P to CB
12/27/2022	4479	Zone Change	North 132' of the east 120' of the east 190' of the SE 1/4 of Tract 36, Hill Heights Addition: County AR to NR-3
12/27/2022	4480	Zone Change	Lot 12-22, Block 720, South Cheyenne: LI to NR-3
1/9/2023	4482	Zone Change	A portion of the NW 1/4 of Section 2, Township 13 North, Range 66 West, of the 6th P.M.: County HI and A-2 to MR
1/9/2023	4484	Zone Change	A portion of the N 1/2 of Section 3, Township 13 North, Range 66 West, of the 6th P.M.: County P to P
2/13/2023	4490	Zone Change	A tract of land in N 1/2 N 1/2 Section 12, Township 13 North, Range 67 West of the 6th P.M.: County LI to LI
3/13/2023	4493	Text Amendment	Amending Section 1.3 soepecifically enforcement of the UDC.
3/13/2023	4494	Zone Change	Lot 1, Block 4, Back 40, 3rd Filing: MUB and CB to CB
3/27/2023	4496	Zone Change	Tracts of land situated in portions of Sunnyside Addition and Sunnyside Addition Second Filing, Section 12, t. 13 N., R. 67 W., 6th p.M.: County MU to MUB and CB
4/10/2023	4498	Zone Change	Tract 12 and 13, Mountain View Homes Subdivision: County LR to LR
5/8/2023	4500	Zone Change	Tract 12, Dell Range Addition, a subdivision of part of the west one-half of Section 22, Township 14 North, Range 66 West of the 6th P.M., Laramie County Wyoming less that portion described in warranty deed recorded in Book 1148 Page 1486 and less that portion being the north 120 feet of the east half of Tract 12, Dell Range Addition: County MR to MR
5/8/2023	4501	Zone Change	Lot 1 and 2, Block 1, Twin 22 Subdivision: MR to NR-2
6/12/2023	4506	Zone Change	Lot 29, Block 1, Eastridge
7/10/2023	4511	Zone Change	The south 144.5' of Tract 25, Dell Range Addition: County A-1 to MR

APPENDIX K – AMENDMENTS, CONTINUED

The following is a log of amendments to this code including text and zoning map amendments. A copy of the official ordinance authorizing the amendments is on file with the City.

DATE	ORD. No.	TEXT AMENDMENT OR ZONE CHANGE	AMENDED SECTIONS OR NEW ZONING DISTRICT
7/10/2023	4513	Zone Change	The north 497.58' of Tract 227, Sunnyside Addition. 6th Filing: County MR to MR
7/10/2023	4514	Zone Change	A parcel of land being a portion of Tract 25, Dell Range Addition and located in the northwest one-quarter of the northwest one-quarter of Section 22, Township 14 North, Range 66 West of the 6th Principal Meridian: County A-1 to AG
7/10/2023	4515	Zone Change	Lot 14 and 15, Christensen Park: LI to MR
7/10/2023	4516	Text Amendment	Amending section 2.4.2 Annexations and creating section 2.2.8, Assigned Zoning, clarifying city zone assignment processes in concert with annexations and when removing city zone districts.
7/10/2023	4517	Text Amendment	Amending section 2.2.1.C.5 and 2.2.2.C.6 amending protest petitions for zoning map amendments and planned developments.
8/14/2023	4519	Zone Change	Lot 2 and 3, GDC Subdivision: HI, AG, and County A-2 to LI
10/9/2023	4526	Zone Change	Lot 1, Block 1, Back 40 Subdivision, Third Filing: MUB to P
10/9/2023	4527	Zone Change	Lots 3, 4, 5, & 6, Block 1, Hitching Post Plaza, 3rd Filing: CB to MUB
11/27/2023	4530	Zone Change	Lot 2, Block 1, Sunnyside Addition, 10th Filing: MUB to CB
12/11/2023	4532	Zone Change	Lots 1 and 2, Block 8, Whitney Ranch, 4th Filing: CB and HR to MUB
12/11/2023	4534	Assigned Zoning	County Pocket Annexation 2: County Zones to City Zones
12/21/2023	4535	Text Amendment	Amending section 5.1.5 removing the minimum lot area requirements for Lot Types DD5 through DD8, SD1 through SD3, AD1 through AD2, and the MD3.
12/21/2023	4536	Text Amendment	Amending section 5.1.5 removing density requirements for the MD1 through MD3 Lot Types.
12/21/2023	4537	Text Amendment	Amending section 6.2.4 table 6-2, changing the parking requirements for multi-family.
1/8/2024	4538	Text Amendment	Amending section 6.7.5.b, Changing building facade design requirements to reduce windows on Urban Loft Multifamily Residential and Mixed-use Residential Development.
1/8/2024	4541	Assigned Zoning	Tract 2, Polk Addition, 2nd Filing: County AR to AR
1/8/2024	4542	Zone Change	Tract 2, Polk Addition, 2nd Filing: AR to LI
1/8/2024	4543	Text Amendment	Amending section 6.6.3.b.3, 6.7.5.c, and 6.9.3.e, changing building facade design requirements for multifamily residential development.
2/12/2024	4546	Assigned Zoning	Tract 6, Dell Range Addition: County AR to AR
2/12/2024	4548	Assigned Zoning	The Bluff's 12th Filing: County A-1 and LR to AG and LR
2/12/2024	4549	Zone Change	The Bluff's 12th Filing: AG and LR to CB and MR
2/12/2024	4550	Zone Change	Lots 1 and 2, Block 7, Meadowbrooke Park: NB to CB
2/12/2024	4551	Zone Change	A portion of Tract 23, Sunnyside Addition, 2nd Filing: MUB to CB
4/8/2024	4556	Zone Change	Lots 2 through 76, Block 1, Cheyenne Terrace, 2nd Filing: MR to NR-2
4/8/2024	4558	Assigned Zoning	A parcel of land being situated in a portion of sections 9,10, 11, 12, 13, 14, 15, and 16, Township 13 north range 67 west of the 6th principal meridian: County Zones to AG, HI, CB, LR, and MR
4/8/2024	4559	Zone Change	A parcel of land being situated in a portion of sections 9,10, 11, 12, 13, 14, 15, and 16, Township 13 north range 67 west of the 6th principal meridian: AG, HI, CB, LR, and MR to LI and AG
5/13/2024	4560	Zone Change	Lot 2, Block 1, Q-B Subdivision: MUB to CB

APPENDIX K – AMENDMENTS, CONTINUED

The following is a log of amendments to this code including text and zoning map amendments. A copy of the official ordinance authorizing the amendments is on file with the City.

DATE	ORD. NO.	TEXT AMENDMENT OR ZONE CHANGE	AMENDED SECTIONS OR NEW ZONING DISTRICT
5/13/2024	4563	Assigned Zoning	A Parcel Of Land Situate In A Portion Of The Southwest Quarter (Sw¼) Northeast Quarter (Ne¼) Southeast Quarter (Se¼) Section 26, T. 14 N., R. 66 W., 6th P.M., Laramie County, Wyoming: County AR to AR
5/13/2024	4566	Assigned Zoning	4204 Dell Range: County MR to MR
5/28/2024	4567	Text Amendment	Amending sections 1.4.3 Defined Terms and 5.8.8 Accessory Buildings, clarifying Detached Buildings.
5/28/2024	4569	Text Amendment	Amending subsections 6.5.4.b.3 Incentives / Bonus, 6.5.4.b.4 Creative Sign Program, and 6.5.8.j Billboards to restructure sign incentives and bonuses by modifying allowances for signs near interstate highways, allowances for shared signs, eliminating the creative sign program, and clarifying applicability of certain billboard allowances.
5/28/2024	4570	Text Amendment	Amending section 5.1.5 to allow up to three stories for detached dwellings, semi-attached dwellings, and attached dwellings.
6/24/2024	4577	Text Amendment	Amending Sectoins 1.4.3 and 2.2.6 to add a minimum of 14 days to temporary uses.
6/24/2024	4578	Text Amendment	Amending Sction 1.4.4.c, Table 5-1, Section 5.7.4 and Table 6-2, changing Child Care regulations.
9/9/2024	4584	Assigned Zoning	A tract of land situate in a portion of the East half of Section 20, T14N. R66W. 6th P.M., Laramie County, Wyoming: County A-1 to AG
9/9/2024	4585	Zone Change	A tract of land situate in a portion of the East half of Section 20, T14N. R66W. 6th P.M., Laramie County, Wyoming: AG to NR-3
9/9/2024	4587	Assigned Zoning	Lots 33 and 34, Sunnyside Addition, 4th Filing, Resub TR 137-140: County MU to MUR
9/9/2024	4588	Zone Change	Lot 1, Block 1, Wyodigs Properties Subdivision: LI to CB
10/14/2024	4590	Text Amendment	Creation of the BP Business Park zone and conforming amendments, as well as correction of references to the SS Support Services District.
11/12/2024	4591	Zone Change	South 33' Lots 3 and 4, Block 234, Original City: Adding the UU Overlay
11/12/2024		Zone Change	Lot 1, Block 1, Cheyenne Business Parkway, Thirteenth Filing: AG and HI to AG
12/9/2024	4593	Assigned Zoning	North Range Business Park: County PUD and LI to BP and LI
12/9/2024	4597	Assigned Zoning	County Pocket Annexation #3: County Zone to City Zone
12/9/2024	4599	Assigned Zoning	County Pocket Annexation #4: County Zone to City Zone
12/9/2024	4600	Zone Change	Lot 1, Block 1, Holliday Park: P and MUR to MUB with the UU Overlay.
12/23/2024	4604	Text Amendment	Amending Sections 6.6.3.b.3, 6.7.5.c, and 6.9.4.e, changing building facade design requirements for multifamily residential development.
1/13/2025	4608	Assigned Zoning	Lot 10, Ridge Homes: County MR to City MR
1/13/2025	4610	Zone Change	Land located northwest of the intersection of West Allison Road and Walterscheid Boulevard: County A-1 to City AG.
1/13/2025	4611	Zone Change	Lot 1, Block 10, Harmony Valley, 1st Filing and Lot 1, Block 10, Interior Heights, 4th Filing: PUD to NR-3
3/10/2025	4617	Text Amendment	Removing the land use term 'Work Camps' and prohibiting their establishment within the City.

APPENDIX L – RUCAOs AND PUDs

The following is a log of RUCAOs and PUDs. A copy of the official files and ordinances authorizing these developments and districts is on file with the City.

DATE	ORD. No.	PUD OR RUCAO NAME	PUD OR RUCAO	DESCRIPTION
8/2/1984	2820	Redwood Villa	PUD	Replat of a portion of Redmond Addition. Residential subdivision on north side of Dell Range between Townsend & Ogallala.
11/26/1984	2837	Overland Trails	PUD	West of I-25 & W. College Drive. Includes McDonalds, Flying J, hotel, Ridge Equipment & Truck Repair. Other areas subsequently rezoned.
7/3/1985	2878	Silvergate Addition, 2nd Filing	PUD	Residential subdivision & church northeast of East Lincolnway & Pinion Dr.
11/7/1985	2896	Fairway Addition	PUD	Office building at 236 Manewal Dr.
1/7/1986	2916	Silver East Subdivision	PUD	Mixed use five-lot subdivision at northeast corner of N. College Dr. & E. 12th.
5/25/1988	3027	Highland Village	PUD	Amended 1982 Ord. #2645. Residential subdivision northwest of E. Fox Farm Rd & Morrie Ave.
9/23/1994	3237	Frontier Square	PUD	Amended 1982 Ord #2600. Commercial development including Target on the north side Dell Range between Frontier Mall Dr. & Prairie Ave.
5/15/1995	3256	Airport Valley Tracts	PUD	Amended 1987 Ord #2994. Church property at 600 E. Carlson St.
3/19/1997	3294	G&F Diamond Development	PUD	Amended 1984 Ord #2847, 1983 Ord #2732, 1982 Ord #2639. Vacant land at 4200 McCann Ave. & City-owned land along Dry Creek.
5/21/1997	3297	Block 596 Original City	PUD	Amended 1987 Ord #2975. Church at 711 Warren Ave.
6/17/2003	3522	The Victorians	PUD	Small-lot residential on Cobblestone Ct. in 4000 block of N. College Dr.
9/21/2004	3599	Transit Facility	RUCAO	City fleet center at 2617 Old Happy Jack Rd.
9/22/2004	3597	Harmony Meadows, 2nd Filing	PUD	Residential subdivision at the southwest corner of Allison Rd. & Walterscheid.
8/27/2005	3664	Cheyenne Street Four-plexes	PUD	Four-plexes at northeast corner of Cheyenne St. & N. College Dr.
10/15/2005	3670	College Business Park	PUD	Commercial business park at northeast corner of Laramie St. & N. College Dr.
9/16/2006	3724	Frontier Mall	PUD	Amended 1991 Ord. 3132, which amended 1979 Ord #2278.
12/16/2006	3732	Paul A. Smith Manor	PUD	Residential & office in Lakeview Historic District on north side E. 25th between Van Lennen & Maxwell Ave.
2/16/2007	3741	The Village	PUD	Mixed-use development on Old Town Ln. between Sycamore & Powderhouse.
12/31/2007	3783	Life Care Center	PUD	Assisted living center at 1330 & 1406 Prairie Ave.
12/13/2008	3835	JL Ranch	PUD	Residential subdivision & church on HR Ranch Rd. west of Burlington Trail.
1/16/2009	3839	South Park Estates	RUCAO	South Park Estates, 6th Filing, north of I-80 between Walterscheid & Stanfield.
2/14/2009	3841	Pointe Plaza	PUD	Mixed-use development, west side Powderhouse north & south of Spirit Ln.
6/13/2009	3850	Storey Acres, 2nd Filing	PUD	Commercial subdivision, south side Storey between Sunset & Townsend Pl.
4/16/2010	3886	Block 140A	PUD	State-owned parking lot bound by Warren, 24th, Central, & 25th.
10/18/2011	3931	Hospital Center, 1st Filing	PUD	Cheyenne Regional Medical Center, east side Warren north & south of 24th.
12/17/2011	3938	Mountview Park, Block 5	PUD	Safeway, formerly Cole Shopping Center, southeast corner of Converse & E. Pershing Blvd.
8/19/2013	3989	Swan Ranch II Annexation	PUD	Industrial Rail Park, west side Clear Creek Pkwy. north of Tundra.
10/14/2016	4154	Pump House RUCAO	RUCAO	Original City, Pumphouse Park south of W. Lincolnway, east of Ames Ave.
4/14/17	4173	Sunflower PUD	PUD	BEAST Program at 2900 Sunflower Road. Amended by Ord. #4198 (effective 9/16/2017) to allow wireless antennas as an admin use.
6/23/2018	4232	Sweetgrass PUD	PUD	Large-scale mixed-use development south of LCCC (over 2,000 acres).

